

MACHINE : 5-axis M/C

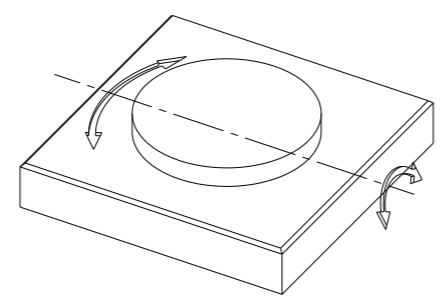
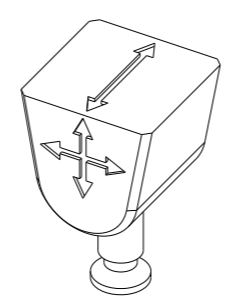

WORK : SINGLE BLADE

WORKPIECE MATERIAL - TITANIUM

Unspecified Tolerances	Draw			Customer: TUNGALOY	Japan	
Dim.s: --	Design			Designation: <b>LAYOUT-SINGLE BLADE-61144</b>		
Angles: --	Check			Process		Page 1 Of 1
	Appr.			Lead Drawing		Rev. No.
	Scale			-		Reg.No. <b>61144/1</b>
	© 2019 Tungaloy Corporation - Copyrights Notice			FL-40030981		A3L

MODEL IN SCALE 3:4 TOOLS IN SCALE 1:2

**CUT 101**  
**Radius Milling Rough**  
 TXLN06M050B22.0R05  
 LNMX0607R6-MJ AH3225

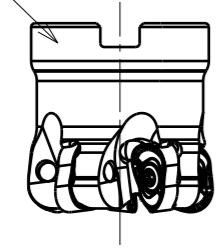

**DoTwistBall**

**CUT 101**  
**High Feed Milling Rough**  
 EXN03R032M32.0-06-C  
 LNMU0303ZER-ML AH130

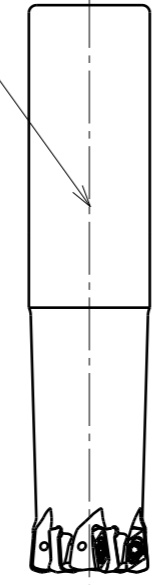

**DoFeed**

**CUT 101**  
**Shoulder Milling Rough**  
 TECK160H4M-32C16CF-R08 AH725



**SolidMeister  
 VariableMeister**

**CUT 102**  
**High Feed Milling Rough**  
 EXLS02M016C16.0LH30R05  
 LSMT0202ZER-HM AH3225

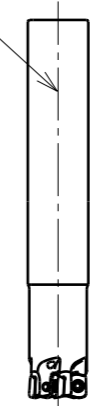

**TungForceFeed**

**CUT 102**  
**High Feed Milling Rough**  
 TEFF100N4-040/30C10R16M AH750



**FeedMeister**

**CUT 102**  
**Slot & Shoulder Milling Rough**  
 VSSD10L075S06-S  
 VEH100L07.0R10I04S06 AH725

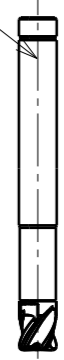

**TungMeister**

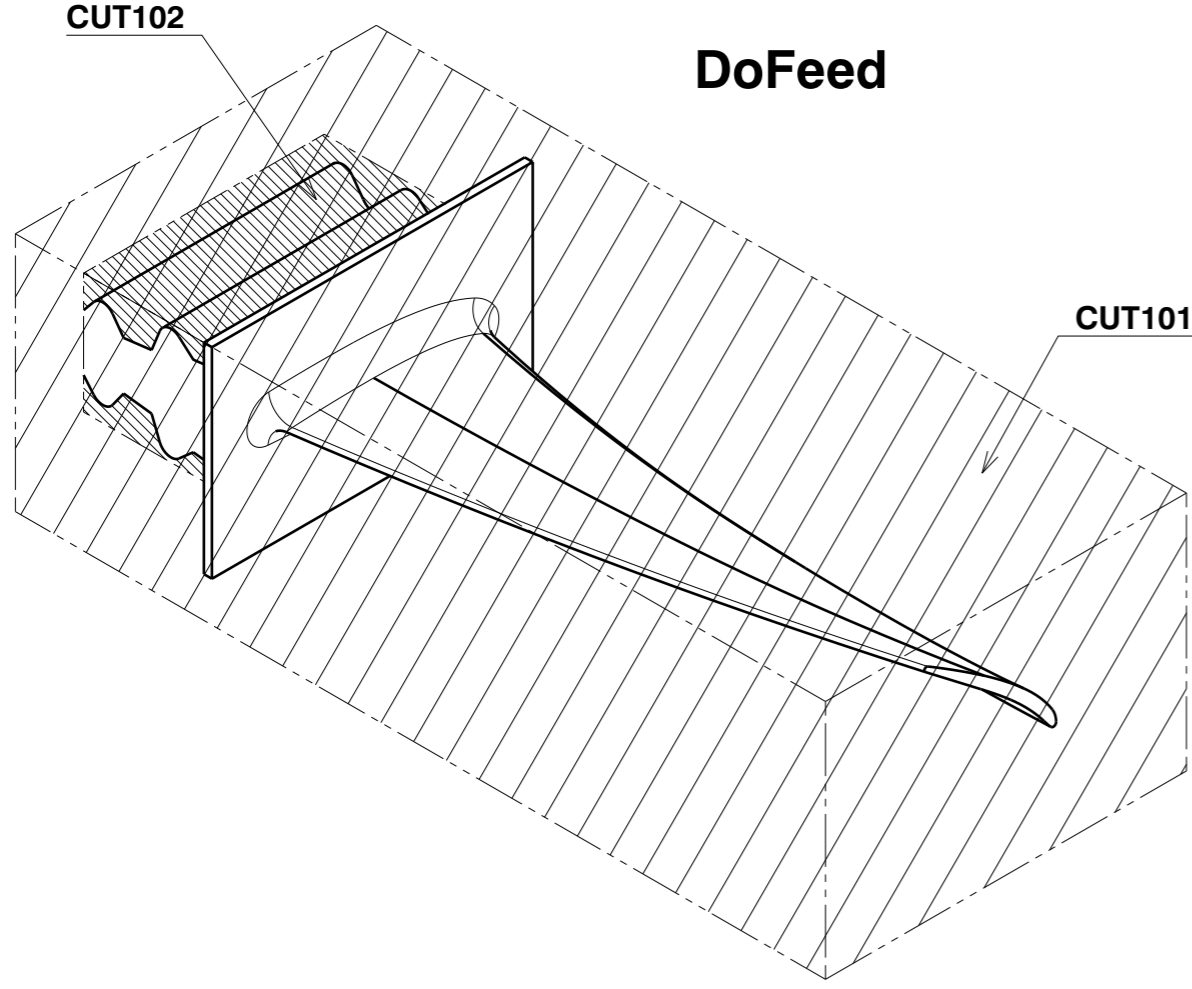

**5Axis M/C : Rough Milling**

Unspecified Tolerances	Draw		Customer: TUNGALOY	Japan	
Dim.s:	Design		Designation:		
Angles:	Check		LAYOUT-SINGLE BLADE-61144		Page 1
	Appr.		Process	Layout.	Of 1
	Scale		Concept		Rev. No. 1
					Reg.No. 61144/1
					A3L



© 2019 Tungaloy Corporation  
 - Copyrights Notice



MODEL IN SCALE 3:4 TOOLS IN SCALE 1:2

**CUT 103/104**  
**Profile Milling Medium & Finish**  
 VTSD16L140S08-S  
 VBD120L09.0-BG-04S08 AH725

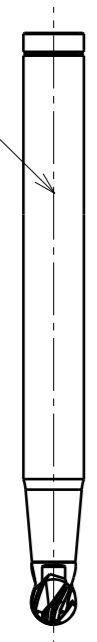

**TungMeister**

**CUT 103**  
**Profile Milling Medium**  
 VSSD12L090S08-C  
 VBO120L19.0R800-5S08 AH715 (Special)

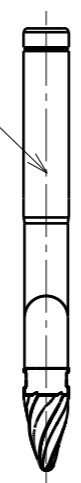

**TungMeister**

**CUT 105**  
**Slot Milling Finish**  
 TECK050H4M-10C06CF-R02 AH725

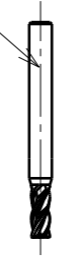

**SolidMeister  
VariableMeister**

**CUT 106**  
**Shoulder Milling Finish**  
 TEC160H16-32C16CF-H92 AH710



**SolidMeister  
VariableMeister**

**CUT 105/106**  
**Slot & Shoulder Milling Finish**  
 EPAV06M012C12.0R03  
 AVGT060302PBER-MJ AH130

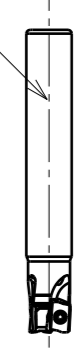

**TungForceRec**

**CUT 107**  
**Profile Milling**  
 Special Holder (Special)  
 Special Head (Special)

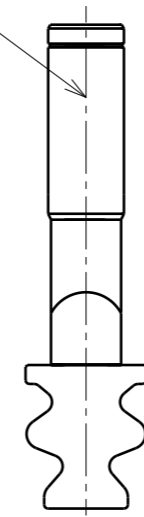

**TungMeister  
SpecialTool**

**CUT 107**  
**Profile Milling Finish**  
 TEB040A4-07C06-50

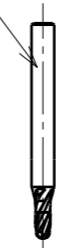

**SolidMeister**

**CUT 108**  
**Profile Milling Finish**  
 Taper Ball Endmill (Special)

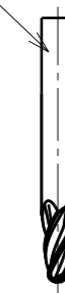

**SolidMeister**

**CUT 109**  
**Chamfering Finish**  
 VSSD12L090S08-C  
 VCA120L05.0A45-04S08

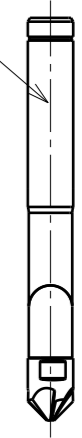

**TungMeister**

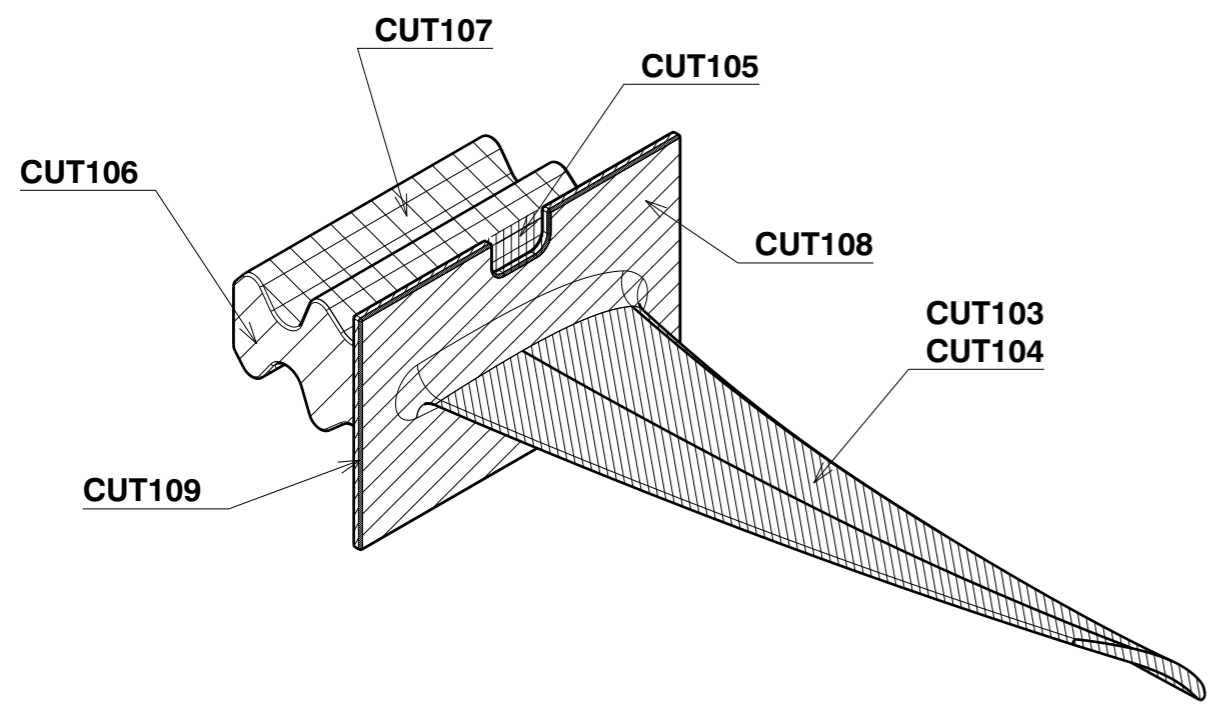

**5Axis M/C : Finish Milling**

Unspecified Tolerances	Draw		Customer: TUNGALOY	Japan	
Dim.s:	Design		Designation:		
Angles:	Check		LAYOUT-SINGLE BLADE-61144		Page 1
	Appr.		Process	Layout.	Of 1
	Scale		Concept		Rev. No. 1
					Reg.No. 61144/1
					A3L