

# Drilling Tool

---



# Drilling Tool - Content structure

- Products are listed in the order of 2 effective drill, 4 effective drill, indexable drill, deep hole drill, then reamer.
- The lists for each item start from the smallest tool diameter.

## How to use the page

- Method ①** Select the drill shape described at the left edge of each page, jump to the page on the left index, and choose a designation you need (④) in the dimension table (⑤). Applicable inserts are shown in (⑥) and (⑧).
- Method ②** Select the drill shape on **J003** and check the details on the product page.
- Method ③** Select the drill series name on **J004 - J005** and check the details on each page.
- Method ④** Select an item from Quick Guide on **J006 - J007**.

**①** **TUNGDRILLTWISTED**  
TDXU-F L/D=5  
Indexable drill, L/D = 5, flat shank with side port

Mech	DC	DC0MM5	DC5PM	LU	LS	LCF	LF	OAL	offset	WT(R)	Insert
TDXU-0205F-05	0.500	0.750	1.250	2.515	2.000	2.630	3.519	5.534	0.200	0.470	XPMT050204R-DJ
TDXU-0255F-05	0.625	0.750	1.250	2.670	2.000	2.790	3.662	5.687	0.204	0.520	XPMT050204R-DJ
TDXU-0305F-05	0.750	1.000	1.500	2.825	2.000	2.950	3.841	5.856	0.218	0.570	XPMT050204R-DJ
TDXU-0355F-05	0.875	1.000	1.500	3.146	2.000	3.270	4.161	6.162	0.226	0.550	XPMT050204R-DJ
TDXU-0405F-05	1.000	1.000	1.457	3.464	2.250	3.580	4.502	6.504	0.248	0.500	XPMT050204R-DJ
TDXU-0455F-05	1.125	1.000	1.457	3.789	2.250	3.850	4.841	7.140	0.257	0.580	XPMT050204R-DJ

**②** **TUNGDRILLTWISTED**  
TDXU-F L/D=5  
Indexable drill, L/D = 5, flat shank with side port

**③** **TUNGDRILLTWISTED**  
TDXU-F L/D=5  
Indexable drill, L/D = 5, flat shank with side port

**④** Designation

**⑤** Dimension table

**⑥** Applicable inserts

**⑦** SPARE PARTS

Drilling length	Tool diameter	Shank diameter	Shank length	Shank thread
0.500	0.500	0.500	0.500	M5x0.8
0.625	0.625	0.625	0.625	M6x1.0
0.750	0.750	0.750	0.750	M8x1.25

Reference pages: Inserts → J008 - J009  
Standard cutting conditions → J090  
J086 tungaloy.com/us

**⑧** INSERT

Designation	IC	LC	RE	DC	DK
XPMT050204R-DJ	0.188	0.177	0.000	0.000	0.000
XPMT050204R-DJ	0.250	0.213	0.000	0.000	0.000
XPMT050204R-DJ	0.312	0.275	0.000	0.000	0.000
XPMT050204R-DJ	0.375	0.338	0.000	0.000	0.000
XPMT050204R-DJ	0.438	0.401	0.000	0.000	0.000
XPMT050204R-DJ	0.500	0.464	0.000	0.000	0.000

**⑨** STANDARD CUTTING CONDITIONS

ISO	Workpiece material	Hardness	Cutting speed Vc (m/min)	Series	Feed F (mm/rev)
P	Low carbon steels (C < 0.25%) 1018, 1026, etc.	-200 HB	525 - 1050	02.080" - 02.080" / 02.080" - 02.080"	0.015 - 0.030
P	Carbon steels (C > 0.25%) 1045, 1045, etc.	-300 HB	282 - 600	02.080" - 02.080" / 02.080" - 02.080"	0.015 - 0.030
P	Low alloy steels 4130, etc.	-200 HB	525 - 600	02.080" - 02.080" / 02.080" - 02.080"	0.015 - 0.030
M	Stainless steels (Austenitic) 304, 316, etc.	-200 HB	328 - 656	02.080" - 02.080" / 02.080" - 02.080"	0.015 - 0.030
M	Stainless steels (Martensitic and Ferritic) 410, 416, etc.	-200 HB	328 - 722	02.080" - 02.080" / 02.080" - 02.080"	0.015 - 0.030
M	Stainless steels (Precipitation hardening) 600, etc.	-282 - 384	202 - 384	02.080" - 02.080" / 02.080" - 02.080"	0.015 - 0.030
K	Gray cast irons Class 15, Class 20, etc.	-200 HB	282 - 600	02.080" - 02.080" / 02.080" - 02.080"	0.015 - 0.030
K	Ductile cast irons 60-40-18, etc.	150 - 250 HB	282 - 656	02.080" - 02.080" / 02.080" - 02.080"	0.015 - 0.030
N	Aluminum alloys 303.0, 303.0, etc.	606 - 1312	400 - 1000	02.080" - 02.080" / 02.080" - 02.080"	0.015 - 0.030
S	Heat-resistant alloys Inconel 718, etc.	-40 HRC	66 - 132	02.080" - 02.080" / 02.080" - 02.080"	0.015 - 0.030
S	Titanium alloys Ti-6Al-4V, etc.	-40 HRC	131 - 262	02.080" - 02.080" / 02.080" - 02.080"	0.015 - 0.030
H	Hardened steel AISI 52100, etc.	-50 HRC	101 - 202	02.080" - 02.080" / 02.080" - 02.080"	0.015 - 0.030





**⑩** Reference pages: Inserts → J008 - J009  
Standard cutting conditions → J090  
J086 tungaloy.com/us

- ① : Drill Shape
- ② : Name of the series
- ③ : Appearance and dimensions
- ④ : Designation
- ⑤ : Dimension
- ⑥ : Applicable inserts
- ⑦ : Spare parts
- ⑧ : Inserts
- ⑨ : Standard cutting conditions
- ⑩ : Reference page

## When ordering

- Please specify the designation and quantity for Indexable drills.  
e.g. **TDXU-0625S-02...** 1 (one Indexable drill per package)
- Please specify the designation, grade, and quantity for inserts.  
e.g. **XPMT050204R-DJ AH725 ...** 10 (10 inserts per package)  
\*You will find a note if the number per package is not 10.
- Please specify the designation and quantity for solid/brazed drills.  
e.g. **DSW030-014-06DE3 ...** 1 (one solid/brazed drill per package)

# Drilling Tool

			Inch	Metric
	2 Effective Drill	J004, J006 J009 -	✓	✓
	4 Effective Drill	J004, J006 J066	✓	✓
	Indexable Drill	J004, J006 - J069 -	✓	✓
	Deep Hole Drill	J004, J007 J105 -	✓	✓
	Reamer	J007 J182 -	✓	✓

# Basic Selection of Drilling Tools

Application ranges of drilling tools

## Exchangeable Head Drills & Indexable Drills

Inch

### 2 Effective Drill

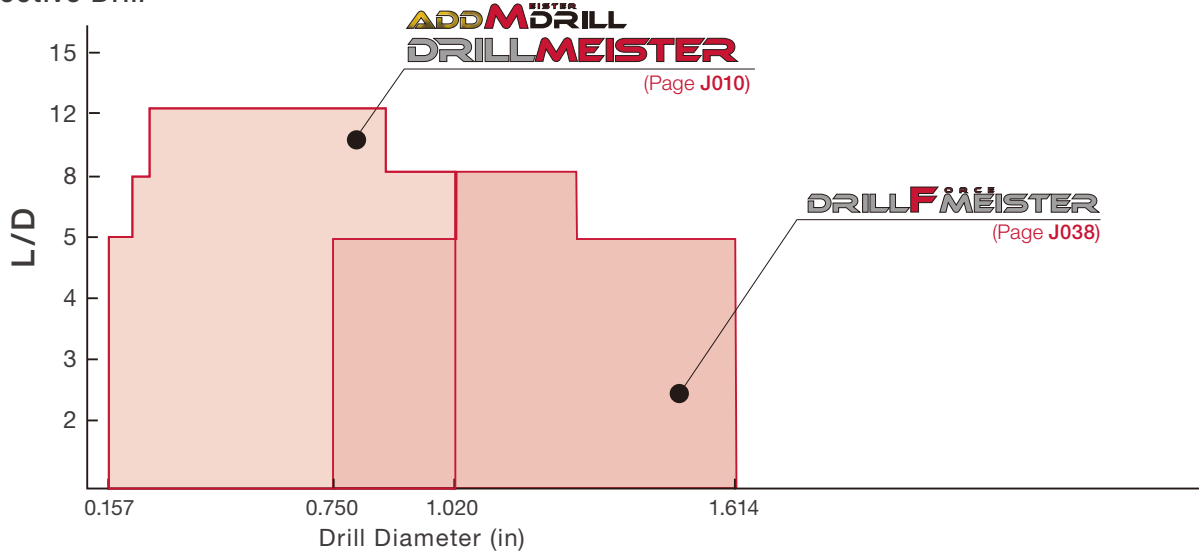

### Indexable Drill

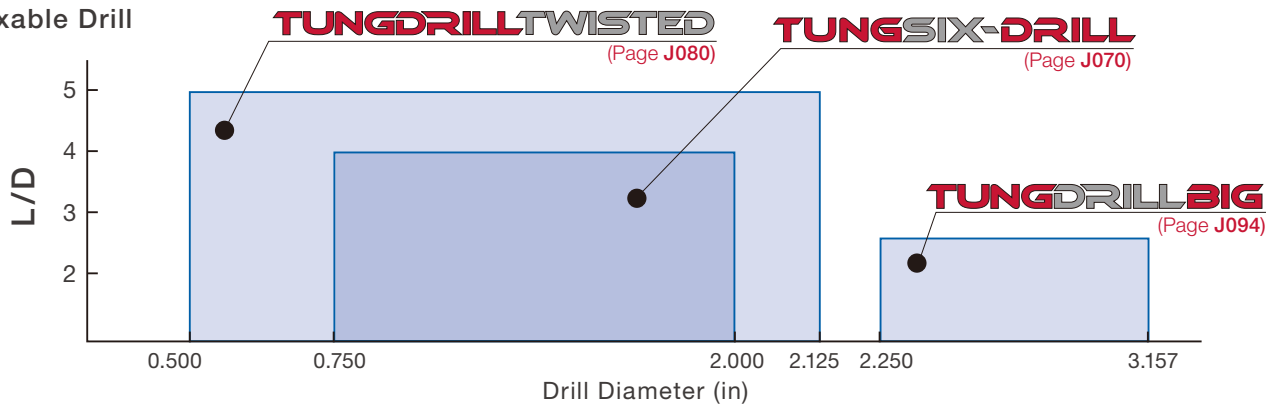

### Deep Hole Drill

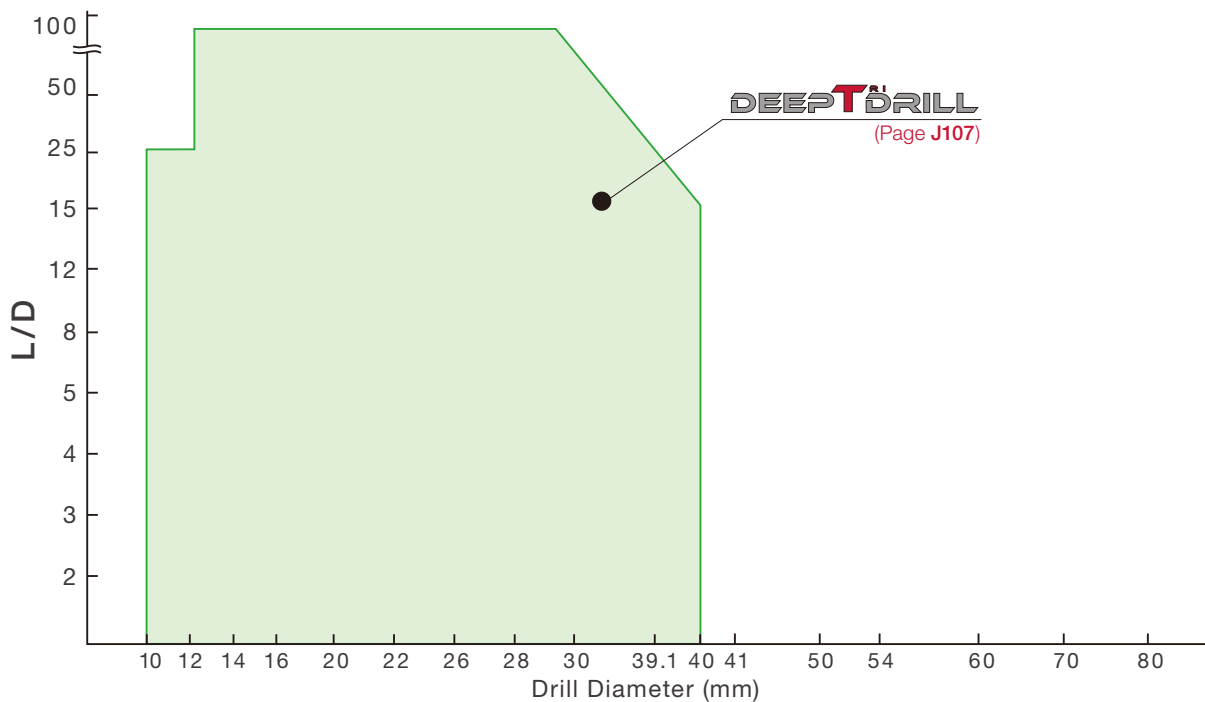



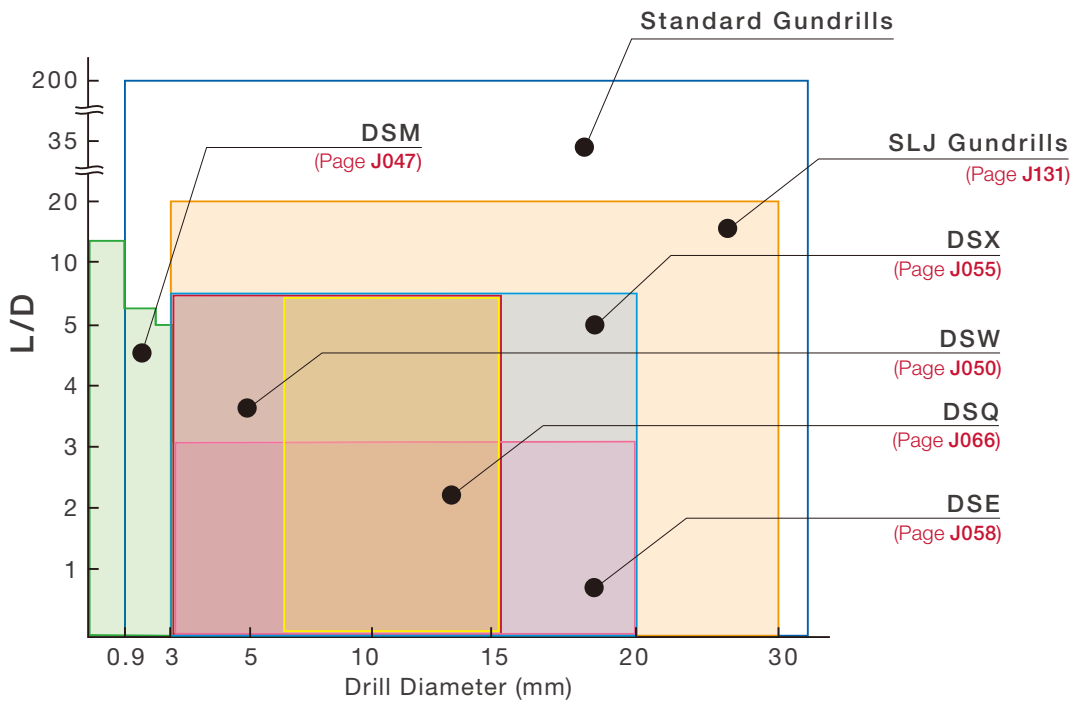

## Hole diameter tolerance\*

\*Just for reference

### TUNGSIX-DRILL

L/D	in / mm	Tool diameter	Hole diameter tolerance*
2	inch	ø0.750 - ø1.062	+ 0.014 / 0
	mm	ø20 - ø27 ø28 - ø54	+ 0.25 / 0 + 0.3 / 0
3	inch	ø0.750 - ø1.062	+ 0.014 / 0
	mm	ø20 - ø27 ø28 - ø54	+ 0.25 / 0 + 0.3 / 0
4	inch	ø0.750 - ø2.000	+ 0.014 / 0
	mm	ø20 - ø27 ø28 - ø54	+ 0.3 / 0 + 0.35 / 0

### ADD M<sup>IT</sup> DRILL

L/D	in / mm	Tool diameter	Hole diameter tolerance*
3	mm	ø4 - ø5.9	+ 0.04 / 0
5	mm	ø4 - ø5.9	+ 0.05 / 0

### DRILLMEISTER

L/D	in / mm	Tool diameter	Hole diameter tolerance*
1.5	inch	ø0.394 - ø0.705	+ 0.0012 / 0
	mm	ø0.709 - ø1.020 ø6 - ø17.9 ø18 - ø25.9	+ 0.0014 / 0 + 0.03 / 0 + 0.035 / 0
2	inch	ø0.236 - ø0.665	+0.0016 / 0
	mm	ø6 - ø16.9	+ 0.04 / 0
3	inch	ø0.394 - ø0.705	+ 0.0015 / 0
	mm	ø0.709 - ø1.020 ø6 - ø17.9 ø18 - ø25.9	+ 0.0018 / 0 + 0.04 / 0 + 0.045 / 0
3.5	inch	ø0.236 - ø0.783	+0.0016 / 0
	mm	ø6 - ø19.9	+ 0.04 / 0
5	inch	ø0.394 - ø1.020	+ 0.0020 / 0
	mm	ø6 - ø25.9	+ 0.05 / 0
6	inch	ø0.236 - ø0.705	+0.0019 / 0
	mm	ø0.709 - ø0.783 ø6 - ø17.9 ø18 - ø19.9	+0.0021 / 0 + 0.05 / 0 + 0.055 / 0
8	inch	ø0.394 - ø0.705	+ 0.0020 / 0
	mm	ø0.709 - ø1.020 ø7 - ø17.9 ø18 - ø25.9	+ 0.0022 / 0 + 0.05 / 0 + 0.055 / 0
12	inch	ø0.315 - ø0.705	+0.0019 / 0
	mm	ø0.709 - ø1.020 ø8 - ø17.9 ø18 - ø25.9	+0.0021 / 0 + 0.05 / 0 + 0.055 / 0

### DRILLFÄHIGER

L/D	in / mm	Tool diameter	Hole diameter tolerance*
3	inch	ø1.024 - ø1.177	+ 0.0020 / 0
	mm	ø1.181 - ø1.614 ø20 - ø29.9 ø30 - ø41	+ 0.0024 / 0 + 0.05 / 0 + 0.06 / 0
5	inch	ø1.024 - ø1.177	+ 0.0030 / 0
	mm	ø1.181 - ø1.614 ø20 - ø29.9 ø30 - ø41	+ 0.0035 / 0 + 0.08 / 0 + 0.09 / 0
8	inch	ø0.787 - ø1.177	+0.0031 / 0
	mm	ø1.181 - ø1.614 ø26 - ø29.9 ø30 - ø33.9	+0.0035 / 0 + 0.08 / 0 + 0.09 / 0

### TUNGDRILLTWISTED

L/D	in / mm	Tool diameter	Hole diameter tolerance*
2	inch	ø0.500 - ø0.625	+ 0.010 / 0
	mm	ø0.687 - ø2.125 ø12.5 - ø17 ø17.5 - ø54	+ 0.012 / 0 + 0.25 / 0 + 0.3 / 0
3	inch	ø0.500 - ø0.625	+ 0.010 / 0
	mm	ø0.687 - ø2.125 ø12.5 - ø17 ø17.5 - ø54	+ 0.012 / 0 + 0.25 / 0 + 0.3 / 0
4	inch	ø0.500 - ø0.625	+ 0.016 / 0
	mm	ø0.687 - ø2.125 ø12.5 - ø17 ø17.5 - ø54	+ 0.019 / 0 + 0.4 / 0 + 0.45 / 0
5	inch	ø0.500 - ø0.625	+ 0.016 / 0
	mm	ø0.687 - ø2.125 ø12.5 - ø17 ø17.5 - ø54	+ 0.018 / 0 + 0.4 / 0 + 0.45 / 0

### DEEPT<sup>DRILL</sup>

L/D	in / mm	Tool diameter	Hole diameter tolerance*
8	inch	ø1.303 - ø1.539	+0.0019 / -0.0039
	mm	ø33.1 - ø39.1	+ 0.05 / - 0.1
10	inch	ø0.625 - ø1.062	+ 0.002 / - 0.004
	mm	ø1.125 - ø1.500 ø16 - ø26 ø28.58 - ø40	+ 0.002 / - 0.004 + 0.05 / - 0.1 + 0.05 / - 0.1
15	inch	ø0.472 - ø1.102	+ 0.002 / - 0.004
	mm	ø1.125 - ø1.500 ø12 - ø13.99 ø14 - ø28 ø28.58 - ø40	+ 0.002 / - 0.004 + 0.05 / - 0.11 + 0.05 / - 0.1 + 0.05 / - 0.1
20	inch	ø0.472 - ø0.5507	+0.0019 / -0.0043
	mm	ø0.5512 - ø0.591 ø12 - ø13.99 ø14 - ø15	+0.0019 / -0.0039 + 0.05 / - 0.11 + 0.05 / - 0.1
25	inch	ø0.437 - ø1.102	+ 0.002 / - 0.004
	mm	ø0.578 - ø0.937 ø1.125 - ø1.500 ø10 - ø13.99 ø14 - ø28 ø28.58 - ø38.1	+ 0.002 / - 0.004 + 0.002 / - 0.004 + 0.05 / - 0.11 + 0.05 / - 0.1 + 0.05 / - 0.1
35, 40, 45	inch	ø0.4374	+ 0.002 / - 0.004
	mm	ø12 - ø13.99 ø14 - ø15	+ 0.05 / - 0.11 + 0.05 / - 0.1







# General drilling - Quick Guide

★ : First choice  
☆ : Second choice

Tool series	Designation	Appearance	Tool diameter	Effective Cutting edge	L/D	Coolant supply	IT class	Workpiece material					Remark	Page	
								P	M	K	N	S			H
<b>ADD M DRILL</b>	TID		ø0.157" - ø0.232" ø4 - ø5.9 mm	2	③ ⑤	Int.	8 - 10	★	★	★	★	★	★	Exchange-able head drill	J010 -
<b>DRILLMEISTER</b>	TIDU TID TIDC TIDCF		ø0.394" - ø1.020" ø6 - ø25.9 mm	2	①.⑤ ② ③ ③.⑤ ⑤ ⑥ ⑧ ⑫	Int. / Ext.	8 - 10	★	★	★	★	★	★	Exchange-able head drill	J012 -
<b>DRILL F MEISTER</b>	TIS		ø1.024" - ø1.614" ø20 - ø41 mm	2	③ ⑤ ⑧	Int.	9 - 10	★	★	★	☆	★	★	Exchange-able head drill	J038 -
<b>SOLID DRILL</b>	DSM DSM-CP		ø0.1 - ø3 mm	2	⑤ ⑩ ⑮	Ext.	9 - 10	★	★	★	☆	☆	☆	Solid drill	J047 -
	CDS		ø1 - ø9 mm	2	③ - ⑧	Ext.	9 - 10			★	★			Solid drill	J049
	DSW		ø3 - ø12 mm	2	③ ⑤ ⑧	Int. / Ext.	9 - 10	★	★	★	☆	★	☆	Solid drill	J050 -
	DSXU DSX		13/64" - 21/32", ø3 - ø20 mm	2	③ ⑤ ⑧	Int.	9 - 10	★	★	★	☆	☆	☆	Solid drill	J055 -
	DSE		ø3 - ø15 mm	2	② ③	Ext.	9 - 10	★	☆	☆	☆	★	☆	Solid Drill	J058
	FDCU FDC		ø0.203" - ø0.344", ø5 - ø16 mm	2	⑤ ⑧	Int.	9 - 10			★	★			Solid Drill	J060
	DMXU DMX		#34" - 25/32", ø3 - ø16.5 mm	2	② ③	Ext.	9 - 10	★	☆	☆	☆	★	☆	Solid Drill	J061
	DMX-F		ø3 - ø12.5 mm	2	③ ⑤	Ext.	9 - 10			★	★			Solid Drill	J064 -
	FDS		ø11 mm	2	③	Ext.	8 - 10			★	★			Solid Drill	J065
	<b>SOLID 4 FLUTE DRILL</b>	DSQ		ø0.236" - ø0.630", ø6 - ø16 mm	4	③ ⑤	Ext.	9 - 10			★				Solid Drill
<b>TUNG SIX-DRILL</b>	TDS		ø0.750" - ø1.062", ø20 - ø54 mm	1	② ③ ④	Int.	11 - 13	★	★	★	☆	★	★	Indexable drill	J070 -
<b>TUNG DRILL TWISTED</b>	TDX		0.500" - 2.125", ø12.5 - ø54 mm	1	② ③ ④ ⑤	Int.	11 - 13	★	★	★	☆	★	★	Indexable drill	J080 -
<b>TUNG DRILL BIG</b>	TDS TDX		ø2.250" - ø3.157", ø55 - ø80 mm	1	②.⑤	Int.	11 - 13	★	★	★	☆	★	★	Indexable drill	J094 -

# Deep drilling - Quick Guide

★ : First choice  
☆ : Second choice

Tool series	Designation	Appearance	Tool diameter	Effective Cutting edge	L/D	Coolant supply	IT class	Workpiece material					Remark	Page	
								P	M	K	N	S			H
<b>DEEPTDRILL</b>	<b>MCTR/TRLG</b>		0.394" - 1.575", ø10 - ø40 mm	1	8 10 15 20 25 35 40 45 (for machining centers) Length ≤ 1650 mm (for gundrill machines)	Int.	IT10-11	★	☆	★	☆	☆	☆	Indexable drill	<b>J107 -</b>
<b>GUNDRILL</b>	<b>SLJ</b>		ø3 - ø12.2 mm	1	Length ≤ 1650 mm (for gundrill machines)	Int.	IT7-8	☆	☆	★	★	☆	☆	Brazed tool	<b>J131</b>
<b>TRI-FINE</b>	<b>FNTR</b>		ø0.630" - ø1.102", ø16 - ø28 mm	1	-	Int.	IT10	★	★	★	☆	★	★	Indexable drill	<b>J134 -</b>
<b>FINE-BEAM</b>	<b>FNBM</b>		ø0.984" - ø3.504", ø25 - ø65 mm	1	-	Int.	IT10	★	★	★	☆	★	★	Indexable drill	<b>J139 -</b>
<b>UNIDEX</b>	<b>MBU/UTE/BTU</b>		ø1.496" - ø11.574", ø38 - ø106.99 mm	1	-	Int.	IT10	★	★	★	☆	☆	☆	Indexable drill	<b>J147 -</b>
Brazed BTA drill	<b>MBU/UTE/BTU</b>		ø0.315" - ø2.559", ø8 - ø65 mm	1	-	Int.	IT9	★	★	★	☆	☆	☆	Brazed tool	<b>J168 -</b>
<b>HF drill</b>	<b>HF</b>		ø30 - ø69 mm	1	6 - 14	Int.	IT10	★	☆	★	☆	★	☆	Indexable drill	<b>J181</b>

# Reaming - Quick Guide

★ : First choice  
☆ : Second choice

Tool series	Designation	Appearance	Tool diameter	Effective Cutting edge	L/D	Coolant supply	IT class	Workpiece material					Remark	Page	
								P	M	K	N	S			H
<b>REAMMEISTER</b>	<b>TRM</b>		ø0.453" - ø1.260, ø11.5 - ø32 mm	6, 8	1.5 3 5 8	Int.	IT7	★	★	★	☆	★	★	Indexable drill	<b>J182 -</b>

Grade  
Insert  
Ext. Toolholder  
Int. Toolholder  
Threading  
Grooving  
Miniature tool  
Milling cutter  
Endmill  
Drilling tool  
Tooling System  
User's Guide  
Index















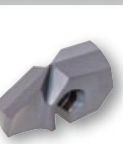

DrillMeister

## 2 Effective Drill

### Exchangeable head drill

		Inch	Metric
		<input type="checkbox"/>	<input checked="" type="checkbox"/>
<b>ADDMEISTER DRILL</b> Exchangeable head drill series  $\varnothing 0.157'' - \varnothing 0.232''$ $\varnothing 4 \text{ mm} - \varnothing 5.9 \text{ mm}$ L/D = 3, 5		J010 - J029 -	
		<input checked="" type="checkbox"/>	<input checked="" type="checkbox"/>
<b>DRILLMEISTER</b> Exchangeable head drill series  $\varnothing 0.236'' - \varnothing 1.020''$ , $\varnothing 6 \text{ mm} - \varnothing 25.9 \text{ mm}$ L/D = 1.5, 2, 3, 3.5, 5, 6, 8, 12		J010 J012 - J029 -	
		<input checked="" type="checkbox"/>	<input checked="" type="checkbox"/>
<b>DRILLFORCEMEISTER</b> Two cutting edges for productivity in large diameter drilling  $\varnothing 0.787'' - \varnothing 1.614''$ , $\varnothing 20 \text{ mm} - \varnothing 41 \text{ mm}$ L/D = 3, 5, 8		J038 -	

### Solid Drill

		Inch	Metric
	<b>SOLIDDRILL</b> High performance solid carbide drill	<input checked="" type="checkbox"/>	<input checked="" type="checkbox"/>
	<b>DSM / DSM-CP</b> $\varnothing 0.1 \text{ mm} - \varnothing 3 \text{ mm}$ / L/D = 5, 10, 15	<input type="checkbox"/>	<input checked="" type="checkbox"/>
	<b>CDS</b> $\varnothing 0.4 \text{ mm} - \varnothing 9 \text{ mm}$ / L/D = 3 - 8	<input type="checkbox"/>	<input checked="" type="checkbox"/>
	 <b>DSW</b> $\varnothing 3 \text{ mm} - \varnothing 12 \text{ mm}$ / L/D = 3, 5, 8	<input type="checkbox"/>	<input checked="" type="checkbox"/>
	 <b>DSXU / DSX</b> $13/64'' - 21/32''$ , $\varnothing 3 \text{ mm} - \varnothing 20 \text{ mm}$ / L/D = 3, 5, 8	<input checked="" type="checkbox"/>	<input checked="" type="checkbox"/>
	<b>DSE</b> $\varnothing 3 \text{ mm} - \varnothing 15 \text{ mm}$ / L/D = 2, 3	<input type="checkbox"/>	<input checked="" type="checkbox"/>
	 <b>FDCU / FDC</b> $\varnothing 0.203'' - \varnothing 0.345''$ , $\varnothing 5 \text{ mm} - \varnothing 16 \text{ mm}$ / L/D = 5, 8	<input checked="" type="checkbox"/>	<input checked="" type="checkbox"/>
	<b>DMXU / DMX / DMX-F</b> $\#34'' - 25/32''$ , $\varnothing 3 \text{ mm} - \varnothing 16.5 \text{ mm}$ / L/D = 2, 3, 5	<input checked="" type="checkbox"/>	<input checked="" type="checkbox"/>
	<b>FDS</b> $\varnothing 11 \text{ mm}$ / L/D = 3	<input type="checkbox"/>	<input checked="" type="checkbox"/>





## Exchangeable head drills for unparalleled tool life and machining performance

- Helical margin to prevent chip adhesion between the body and the hole during machining
- Tool body made from highest grade of steel with superior hardness for high wear resistance
- Wide variety of geometries for every drilling application
- Advanced grade options to ensure stable and long tool life.
- Supply efficient internal coolant channels and lubrication during the drilling process.

**ADD M<sup>EISTER</sup> DRILL**

Tool diameter:  
ø0.157" - ø0.232",  
ø4 - ø5.9 mm



**DRILLMEISTER**

Tool diameter:  
ø0.236" - ø1.020",  
ø6 - ø25.9 mm

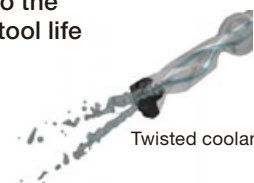
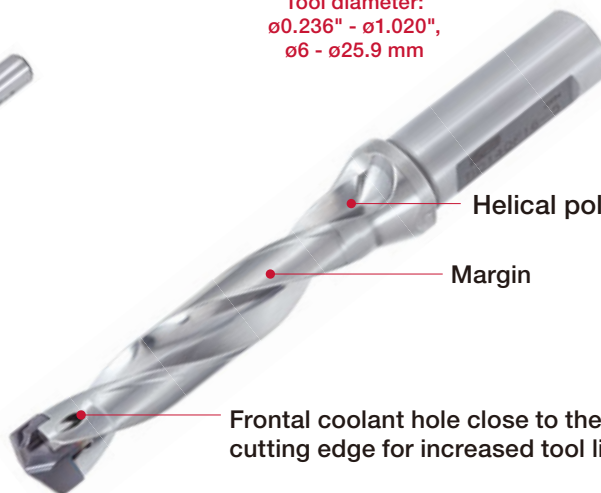

**Quick and precise head changing with advanced self-clamping system**

- Drilling head pocket designed to withstand high machining cutting conditions
- Allows easy and fast head indexing, minimizing machine downtime

Reference pages: **J011 - J037**,  
Technical reference → **L081 -**

## Exchangeable head drill, L/D = 3, Cylindrical shank

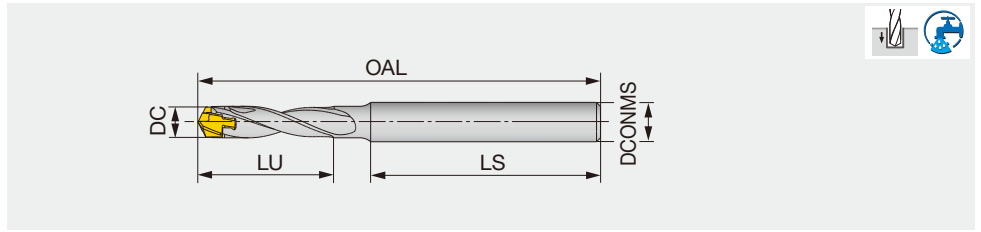

Metric	DC	DCONMS	LU	LS	OAL		Pocket size	Head
					DMP	DMC		
TID040R06-3	4 - 4.4	6	13	35	57.7	58.1	4	DM*040 - DM*044
TID045R06-3	4.5 - 4.9	6	14	35	59.7	59.9	4.5	DM*045 - DM*049
TID050R06-3	5 - 5.4	6	16	35	61.4	61.8	5	DM*050 - DM*054
TID055R06-3	5.5 - 5.9	6	17	35	64	64.3	5.5	DM*055 - DM*059

Tool diameter (mm)	Hole diameter tolerance (mm)*
ø4 - ø5.9	+0.04 / 0

\*Just for reference

- An overall length (OAL) differs based on each head geometry.
- When using the drill at a higher feed rate, make sure to provide an axial support by placing the overhang adjusting screw at the drill shank end in the tool holder. This will prevent high thrust force from pushing the drill back into the holder during drilling.
- When axially adjusting the shank inside the holder to obtain a required drill overhang, make sure the shank length remaining inside the holder does not come short of the minimum clamping length (LSCN) specified by the holder supplier.

## TID-R L/D=5

### Exchangeable head drill, L/D = 5, Cylindrical shank

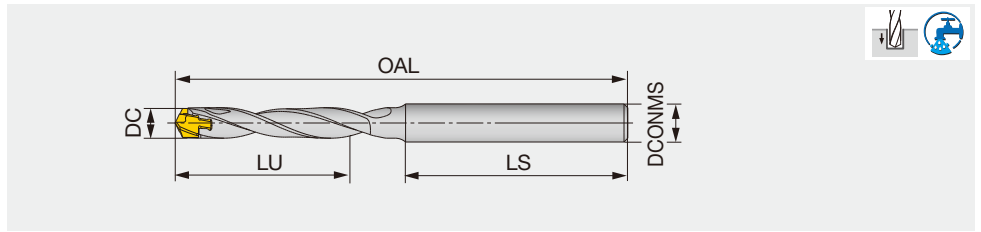

Metric	DC	DCONMS	LU	LS	OAL		Pocket size	Head
					DMP	DMC		
TID040R06-5	4 - 4.4	6	21	35	65.7	66.1	4	DM*040 - DM*044
TID045R06-5	4.5 - 4.9	6	23	35	68.7	68.9	4.5	DM*045 - DM*049
TID050R06-5	5 - 5.4	6	26	35	71.3	71.6	5	DM*050 - DM*054
TID055R06-5	5.5 - 5.9	6	28	35	74.2	74.5	5.5	DM*055 - DM*059

Tool diameter (mm)	Hole diameter tolerance (mm)*
ø4 - ø5.9	+0.05 / 0

\*Just for reference

- The overall length (OAL) differs based on each head geometry.
- When using the drill at a higher feed rate, make sure to provide an axial support by placing the overhang adjusting screw at the drill shank end in the tool holder. This will prevent high thrust force from pushing the drill back into the holder during drilling.
- When axially adjusting the shank inside the holder to obtain a required drill overhang, make sure the shank length remaining inside the holder does not come short of the minimum clamping length (LSCN) specified by the holder supplier.

### SPARE PARTS



Designation	Clamping key
TID040..., TID045...	K-TID4-4.99
TID050..., TID055...	K-TID5-5.99

Reference pages: Head → **J029 - J032**  
Standard cutting conditions → **J037**

# DRILLMEISTER

## TIDU-F L/D=1.5

Exchangeable head drill, L/D = 1.5, flange type

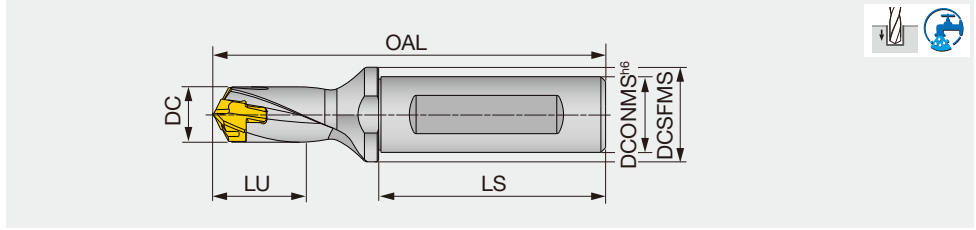

Inch	DC	DCONMS	DCSFMS	LU	LS	OAL			Pocket size	Head
						DMP/H/N	DMC	DMF		
TIDU0394F0625-1.5	0.394 - 0.429	0.625	0.787	0.591	1.890	3.118	3.142	2.638	10	DM*100 - DM*109
TIDU0433F0625-1.5	0.433 - 0.468	0.625	0.787	0.669	1.890	3.193	3.217	2.678	11	DM*110 - DM*119
TIDU0472F0625-1.5	0.472 - 0.508	0.625	0.787	0.709	1.890	3.268	3.292	2.720	12	DM*120 - DM*129
TIDU0512F0625-1.5	0.512 - 0.547	0.625	0.787	0.787	1.890	3.350	3.381	2.749	13	DM*130 - DM*139
TIDU0551F0625-1.5	0.551 - 0.587	0.625	0.787	0.827	1.890	3.508	3.539	2.811	14	DM*140 - DM*149
TIDU0591F0750-1.5	0.591 - 0.625	0.750	0.984	0.906	1.969	3.787	3.822	2.878	15	DM*150 - DM*159
TIDU0630F0750-1.5	0.630 - 0.665	0.750	0.984	0.945	1.969	3.909	3.948	3.060	16	DM*160 - DM*169
TIDU0669F0750-1.5	0.669 - 0.705	0.750	0.984	1.024	1.969	4.031	4.07	3.126	17	DM*170 - DM*179
TIDU0709F1000-1.5	0.709 - 0.744	1.000	1.260	1.063	2.205	4.390	4.433	3.197	18	DM*180 - DM*189
TIDU0748F1000-1.5	0.748 - 0.783	1.000	1.260	1.142	2.205	4.508	4.551	3.269	19	DM*190 - DM*199
TIDU0787F1000-1.5	0.787 - 0.823	1.000	1.260	1.181	2.205	4.630	4.677	3.424	20	DMP200 - DMP209
TIDU0827F1000-1.5	0.827 - 0.862	1.000	1.260	1.240	2.205	4.752	4.800	3.698	21	DMP210 - DMP219
TIDU0866F1000-1.5	0.866 - 0.902	1.000	1.260	1.299	2.205	4.874	4.924	3.813	22	DMP220 - DMP229
TIDU0906F1250-1.5	0.906 - 0.941	1.250	1.654	1.358	2.362	5.150	5.204	3.923	23	DMP230 - DMP239
TIDU0945F1250-1.5	0.945 - 0.980	1.250	1.654	1.417	2.362	5.272	5.327	4.270	24	DMP240 - DMP249
TIDU0984F1250-1.5	0.984 - 1.020	1.250	1.654	1.476	2.362	5.394	5.453	4.381	25	DMP250 - DMP259

Tool diameter (in)	Hole diameter tolerance (in)*
ø0.394" - ø0.705"	+0.0012" / 0
ø0.709" - ø1.020"	+0.0014" / 0

\*Just for reference

- An overall length (OAL) differs for when the DMP insert is mounted and when the DMC is mounted. (No difference for the drill shoulder)  
 - For drill diameters from ø0.315" - ø0.390", the drill shoulder to shank bottom distance when a DMC drill head is mounted is 0.012" shorter when compared with a DMP head of the equivalent sizes. The distances are the same for the DMC and DMP drill heads in other diameters than the above.

### SPARE PARTS



Designation	Clamping key
TIDU0394 - TIDU0748	K-TID10-19.99
TIDU0787 - TIDU0984	K-TID20-26.99

Reference pages: Head → **J029 - J036**  
 Standard cutting conditions → **J037**



## TID L/D=1.5

Exchangeable head drill, L/D = 1.5, flange type

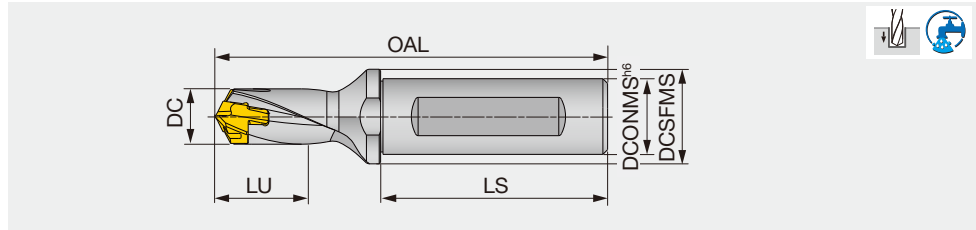

Metric	DC	DCONMS	DCSFMS	LU	LS	OAL			Pocket size	Head
						DMP/H/N	DMC	DMF		
TID060F12-1.5	6 - 6.4	12	16	10	45	67.9	68	67	6	DM*060 - DM*064
TID065F12-1.5	6.5 - 6.9	12	16	11	45	68.9	69.1	68	6.5	DM*065 - DM*069
TID070F12-1.5	7 - 7.4	12	16	12	45	70	70.4	69.1	7	DM*070 - DM*074
TID075F12-1.5	7.5 - 7.9	12	16	13	45	70.7	71.2	69.8	7	DM*075 - DM*079
TID080F12-1.5	8 - 8.9	12	16	14	45	72.3	72.4	71.4	8	DM*080 - DM*089
TID090F12-1.5	9 - 9.9	12	16	16	45	74.2	74.3	73.1	9	DM*090 - DM*099
TID100F16-1.5	10 - 10.9	16	20	17	48	79.1	79.7	77.7	10	DM*100 - DM*109
TID110F16-1.5	11 - 11.9	16	20	19	48	81	81.6	79.4	11	DM*110 - DM*119
TID120F16-1.5	12 - 12.9	16	20	20	48	82.8	83.4	81.2	12	DM*120 - DM*129
TID130F16-1.5	13 - 13.9	16	20	22	48	84.9	85.7	83	13	DM*130 - DM*139
TID140F16-1.5	14 - 14.9	16	20	24	48	89	89.8	87	14	DM*140 - DM*149
TID150F20-1.5	15 - 15.9	20	25	26	50	96	96.9	93.9	15	DM*150 - DM*159
TID160F20-1.5	16 - 16.9	20	25	27	50	99.1	100.1	96.8	16	DM*160 - DM*169
TID170F20-1.5	17 - 17.9	20	25	29	50	102.2	103.2	99.7	17	DM*170 - DM*179
TID180F25-1.5	18 - 18.9	25	32	30	56	111.3	112.4	108.5	18	DM*180 - DM*189
TID190F25-1.5	19 - 19.9	25	32	33	56	114.3	115.4	111.3	19	DM*190 - DM*199
TID200F25-1.5	20 - 20.9	25	32	34	56	117.4	118.6	115.1	20	DM*200 - DM*209
TID210F25-1.5	21 - 21.9	25	32	36	56	120.5	121.7	118	21	DM*210 - DM*219
TID220F25-1.5	22 - 22.9	25	32	37	56	123.6	124.8	120.9	22	DM*220 - DM*229
TID230F32-1.5	23 - 23.9	32	42	39	60	130.6	132	127.8	23	DM*230 - DM*239
TID240F32-1.5	24 - 24.9	32	42	40	60	133.7	135.1	130.7	24	DM*240 - DM*249
TID250F32-1.5	25 - 25.9	32	42	43	60	136.8	138.3	133.7	25	DM*250 - DM*259

Tool diameter (mm)	Hole diameter tolerance (mm)*
ø6 - ø17.9	+0.03 / 0
ø18 - ø25.9	+0.035 / 0

\*Just for reference

- An overall length (OAL) differs based on each head geometry.  
 - For drill diameters from ø8 - ø9.9 mm, the drill shoulder to shank bottom distance when a DMC drill head is mounted is 0.3 mm shorter when compared with a DMP head of the equivalent sizes. The distances are the same for the DMC and DMP drill heads in other diameters than the above.



### SPARE PARTS

Designation	Clamping key
TID060... - TID090...	K-TID6-9.99
TID100... - TID190...	K-TID10-19.99
TID200... - TID250...	K-TID20-26.99

Reference pages: Head → **J029 - J036**  
 Standard cutting conditions → **J037**

# DRILLMEISTER

## TID-R-2E L/D=2

Exchangeable head drill, L/D = 2, Cylindrical shank, for external coolant supply

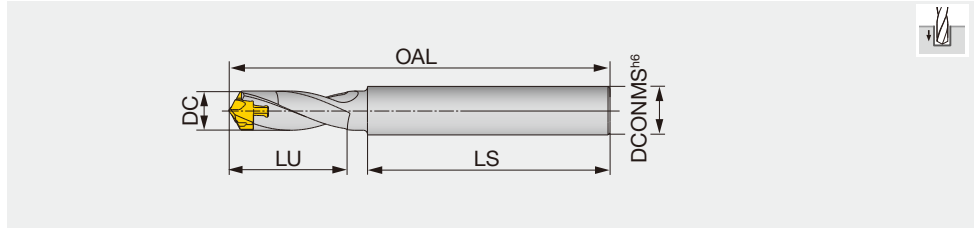

Metric	DC	DCONMS	LU	LS	OAL			Pocket size	Head
					DMP/H/N	DMC	DMF		
TID060R8-2E	6 - 6.4	8	12	45	66.1	66.2	65.2	6	DM*060 - DM*064
TID065R8-2E	6.5 - 6.9	8	13	45	67.2	67.3	66.3	6.5	DM*065 - DM*069
TID070R8-2E	7 - 7.4	8	13	45	68	68.4	67.1	7	DM*070 - DM*074
TID075R8-2E	7.5 - 7.9	8	14	45	69	69.4	68.1	7	DM*075 - DM*079
TID080R10-2E	8 - 8.9	10	15	50	75.2	75.3	74.3	8	DM*080 - DM*089
TID090R10-2E	9 - 9.9	10	17	50	77.4	77.5	76.3	9	DM*090 - DM*099
TID100R12-2E	10 - 10.9	12	22	60	94.3	94.9	92.9	10	DM*100 - DM*109
TID110R12-2E	11 - 11.9	12	24	60	96.5	97.1	94.9	11	DM*110 - DM*119
TID120R14-2E	12 - 12.9	14	26	65	103.6	104.2	102	12	DM*120 - DM*129
TID130R14-2E	13 - 13.9	14	27	65	108.8	109.6	106.9	13	DM*130 - DM*139
TID140R16-2E	14 - 14.9	16	29	70	115	115.8	113	14	DM*140 - DM*149
TID150R16-2E	15 - 15.9	16	32	70	118	118.9	115.9	15	DM*150 - DM*159
TID160R18-2E	16 - 16.9	18	33	70	122.2	123.2	119.9	16	DM*160 - DM*169

Tool diameter (mm)	Hole diameter tolerance (mm)*
ø6 - ø16.9	+0.04 / 0

\*Just for reference

- An overall length (OAL) differs based on each head geometry.
- When using the drill at a higher feed rate, make sure to provide an axial support by placing the overhang adjusting screw at the drill shank end in the tool holder. This will prevent high thrust force from pushing the drill back into the holder during drilling.
- When axially adjusting the shank inside the holder to obtain a required drill overhang, make sure the shank length remaining inside the holder does not come short of the minimum clamping length (LSCN) specified by the holder supplier.
- For drill diameters from ø8 - ø9.9 mm, the drill shoulder to shank bottom distance when a DMC drill head is mounted is 0.3 mm shorter when compared with a DMP head of the equivalent sizes. The distances are the same for the DMC and DMP drill heads in other diameters than the above.

### SPARE PARTS

Designation	Clamping key
TID060... - TID095...	K-TID6-9.99
TID100... - TID160...	K-TID10-19.99

Reference pages: Head → **J029 - J036**  
Standard cutting conditions → **J037**

# TIDU-F L/D=3

Exchangeable head drill, L/D = 3, flange type

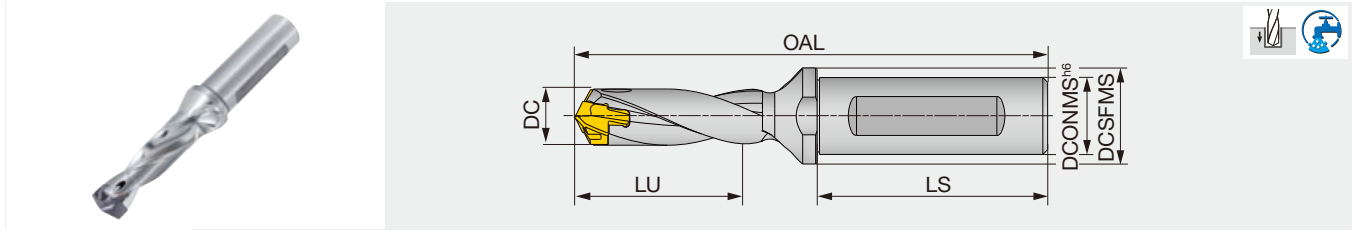

Inch	DC	DCONMS	DCSFMS	LU	LS	OAL			Pocket size	Head
						DMP/H/N	DMC	DMF		
TIDU0394F0625-3	0.394 - 0.409	0.625	0.787	1.181	1.890	3.709	3.733	2.993	10	DM*100 - DM*104
TIDU0413F0625-3	0.413 - 0.429	0.625	0.787	1.260	1.890	3.768	3.792	3.062	10	DM*105 - DM*109
TIDU0433F0625-3	0.433 - 0.449	0.625	0.787	1.299	1.890	3.843	3.867	3.133	11	DM*110 - DM*114
TIDU0453F0625-3	0.453 - 0.469	0.625	0.787	1.378	1.890	3.902	3.926	3.192	11	DM*115 - DM*119
TIDU0472F0625-3	0.472 - 0.488	0.625	0.787	1.417	1.890	3.976	4.000	3.283	12	DM*120 - DM*124
TIDU0492F0625-3	0.492 - 0.508	0.625	0.787	1.457	1.890	4.035	4.059	3.342	12	DM*125 - DM*129
TIDU0512F0625-3	0.512 - 0.528	0.625	0.787	1.535	1.890	4.118	4.149	3.410	13	DM*130 - DM*134
TIDU0532F0625-3	0.532 - 0.547	0.625	0.787	1.614	1.890	4.177	4.208	3.469	13	DM*135 - DM*139
TIDU0551F0625-3	0.551 - 0.567	0.625	0.787	1.654	1.890	4.335	4.366	3.650	14	DM*140 - DM*144
TIDU0571F0625-3	0.571 - 0.587	0.625	0.787	1.732	1.890	4.394	4.425	3.709	14	DM*145 - DM*149
TIDU0591F0750-3	0.591 - 0.626	0.750	0.984	1.772	1.969	4.673	4.708	3.776	15	DM*150 - DM*159
TIDU0630F0750-3	0.630 - 0.665	0.750	0.984	1.890	1.969	4.854	4.893	3.835	16	DM*160 - DM*169
TIDU0669F0750-3	0.669 - 0.705	0.750	0.984	2.008	1.969	5.035	5.074	3.906	17	DM*170 - DM*179
TIDU0709F1000-3	0.709 - 0.744	1.000	1.260	2.126	2.205	5.453	5.496	3.965	18	DM*180 - DM*189
TIDU0748F1000-3	0.748 - 0.783	1.000	1.260	2.244	2.205	5.630	5.673	4.037	19	DM*190 - DM*199
TIDU0787F1000-3	0.787 - 0.823	1.000	1.260	2.362	2.205	5.811	5.838	4.096	20	DMP200 - DMP209
TIDU0827F1000-3	0.827 - 0.862	1.000	1.260	2.480	2.205	5.992	6.040	4.250	21	DMP210 - DMP219
TIDU0866F1000-3	0.866 - 0.902	1.000	1.260	2.598	2.205	6.173	6.223	4.309	22	DMP220 - DMP229
TIDU0906F1250-3	0.906 - 0.941	1.250	1.654	2.718	2.362	6.508	6.562	4.584	23	DMP230 - DMP239
TIDU0945F1250-3	0.945 - 0.980	1.250	1.654	2.835	2.362	6.689	6.744	4.757	24	DMP240 - DMP249
TIDU0984F1250-3	0.984 - 1.020	1.250	1.654	2.953	2.362	6.870	6.939	4.927	25	DMP250 - DMP259

Tool diameter (in)	Hole diameter tolerance (in)*
ø0.394" - ø0.705"	+0.0015" / 0
ø0.709" - ø1.020"	+0.0018" / 0

- An overall length (OAL) differs for when the DMP insert is mounted and when the DMC is mounted. (No difference for the drill shoulder)  
 - For drill diameters from ø0.315"- ø0.390", the drill shoulder to shank bottom distance when a DMC drill head is mounted is 0.012" shorter when compared with a DMP head of the equivalent sizes. The distances are the same for the DMC and DMP drill heads in other diameters than the above.

\*Just for reference

## SPARE PARTS



Designation	Clamping key
TIDU0394 - TIDU0748	K-TID10-19.99
TIDU0787 - TIDU0984	K-TID20-26.99

Reference pages: Head → **J029 - J036**  
 Standard cutting conditions → **J037**

# DRILLMEISTER

## TID L/D=3

Exchangeable head drill, L/D = 3, flange type

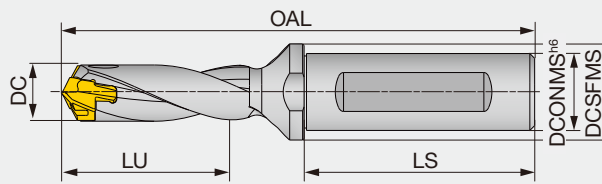

Metric	DC	DCONMS	DCSFMS	LU	LS	OAL			Pocket size	Head
						DMP/H/N	DMC	DMF		
TID060F12-3	6 - 6.4	12	16	19	45	76.9	77	76	6	DM*060 - DM*064
TID065F12-3	6.5 - 6.9	12	16	21	45	78.7	78.8	77.8	6.5	DM*065 - DM*069
TID070F12-3	7 - 7.4	12	16	22	45	80.5	80.9	79.6	7	DM*070 - DM*074
TID075F12-3	7.5 - 7.9	12	16	24	45	82	82.4	81.1	7	DM*075 - DM*079
TID080F12-3	8 - 8.4	12	16	26	45	84.3	84.4	83.4	8	DM*080 - DM*084
TID085F12-3	8.5 - 8.9	12	16	28	45	85.8	85.9	84.9	8	DM*085 - DM*089
TID090F12-3	9 - 9.4	12	16	29	45	87.7	87.8	86.6	9	DM*090 - DM*094
TID095F12-3	9.5 - 9.9	12	16	31	45	89.2	89.3	88.1	9	DM*095 - DM*099
TID100F16-3	10 - 10.4	16	20	32	48	94.1	94.7	92.7	10	DM*100 - DM*104
TID105F16-3	10.5 - 10.9	16	20	34	48	95.6	96.2	94.2	10	DM*105 - DM*109
TID110F16-3	11 - 11.4	16	20	35	48	97.5	98.1	95.9	11	DM*110 - DM*114
TID115F16-3	11.5 - 11.9	16	20	37	48	99	99.6	97.4	11	DM*115 - DM*119
TID120F16-3	12 - 12.4	16	20	38	48	100.8	101.4	99.2	12	DM*120 - DM*124
TID125F16-3	12.5 - 12.9	16	20	39	48	102.3	102.9	100.7	12	DM*125 - DM*129
TID130F16-3	13 - 13.4	16	20	41	48	104.4	105.2	102.5	13	DM*130 - DM*134
TID135F16-3	13.5 - 13.9	16	20	44	48	105.9	106.7	104	13	DM*135 - DM*139
TID140F16-3	14 - 14.4	16	20	45	48	110	110.8	108	14	DM*140 - DM*144
TID145F16-3	14.5 - 14.9	16	20	47	48	111.5	112.3	109.5	14	DM*145 - DM*149
TID150F20-3	15 - 15.9	20	25	48	50	118.5	119.4	116.4	15	DM*150 - DM*159
TID160F20-3	16 - 16.9	20	25	51	50	123.1	124.1	120.8	16	DM*160 - DM*169
TID170F20-3	17 - 17.9	20	25	54	50	127.7	128.7	125.2	17	DM*170 - DM*179
TID180F25-3	18 - 18.9	25	32	57	56	138.3	139.4	135.5	18	DM*180 - DM*189
TID190F25-3	19 - 19.9	25	32	61	56	142.8	143.9	139.8	19	DM*190 - DM*199
TID200F25-3	20 - 20.9	25	32	64	56	147.4	148.6	145.1	20	DM*200 - DM*209
TID210F25-3	21 - 21.9	25	32	67	56	152	153.2	149.5	21	DM*210 - DM*219
TID220F25-3	22 - 22.9	25	32	70	56	156.6	157.8	153.9	22	DM*220 - DM*229
TID230F32-3	23 - 23.9	32	42	73	60	165.1	166.5	162.3	23	DM*230 - DM*239
TID240F32-3	24 - 24.9	32	42	76	60	169.7	171.1	166.7	24	DM*240 - DM*249
TID250F32-3	25 - 25.9	32	42	80	60	174.3	175.8	171.2	25	DM*250 - DM*259

Tool diameter (mm)	Hole diameter tolerance (mm)*
ø6 - ø17.9	+0.04 / 0
ø18 - ø25.9	+0.045 / 0

- An overall length (OAL) differs based on each head geometry.  
 - For drill diameters from ø8 - ø9.9 mm, the drill shoulder to shank bottom distance when a DMC drill head is mounted is 0.3 mm shorter when compared with a DMP head of the equivalent sizes. The distances are the same for the DMC and DMP drill heads in other diameters than the above.

\*Just for reference

### SPARE PARTS



Designation	Clamping key
TID060... - TID095...	K-TID6-9.99
TID100... - TID190...	K-TID10-19.99
TID200... - TID250...	K-TID20-26.99

Reference pages: Head → **J029 - J036**  
 Standard cutting conditions → **J037**

# TIDC L/D=3

Exchangeable head drill, L/D = 3, Cylindrical shank, for chamfering adapter

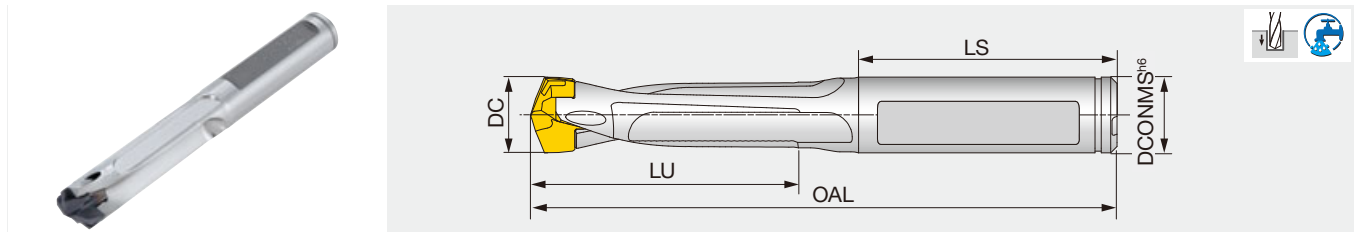

Metric	DC	DCONMS	LU	LS	OAL			Pocket size	Head
					DMP/H/N	DMC	DMF		
TIDC075C8-3	7.5 - 7.9	8	23	36	70.1	70.6	69.2	7	DM*075 - DM*079
TIDC080C8-3	8 - 8.4	8	24	36	70.6	70.8	69.7	8	DM*080 - DM*084
TIDC085C9-3	8.5 - 8.9	9	26	36	72.8	73	71.9	8	DM*085 - DM*089
TIDC090C9-3	9 - 9.4	9	27	36	74.7	74.9	73.7	9	DM*090 - DM*094
TIDC095C10-3	9.5 - 9.9	10	29	36	76.2	76.4	75.2	9	DM*095 - DM*099
TIDC100C10-3	10 - 10.4	10	32	41	86.1	86.7	84.8	10	DM*100 - DM*104
TIDC105C11-3	10.5 - 10.9	11	33	41	87.6	88.2	86.3	10	DM*105 - DM*109
TIDC110C11-3	11 - 11.4	11	35	41	89.5	90.2	88	11	DM*110 - DM*114
TIDC115C12-3	11.5 - 11.9	12	37	41	91	91.7	89.5	11	DM*115 - DM*119
TIDC120C12-3	12 - 12.4	12	38	41	92.8	93.4	91.2	12	DM*120 - DM*124
TIDC125C13-3	12.5 - 12.9	13	40	46	98.3	98.9	96.7	12	DM*125 - DM*129
TIDC130C13-3	13 - 13.4	13	41	47	102.4	103.2	100.5	13	DM*130 - DM*134
TIDC135C14-3	13.5 - 13.9	14	43	43	99.9	100.7	98	13	DM*135 - DM*139
TIDC140C14-3	14 - 14.4	14	45	44	103	103.8	101	14	DM*140 - DM*144
TIDC145C15-3	14.5 - 14.9	15	46	45	105.5	106.3	103.5	14	DM*145 - DM*149
TIDC150C15-3	15 - 15.9	15	48	45	107.5	108.4	105.4	15	DM*150 - DM*159
TIDC160C16-3	16 - 16.9	16	51	48	117.5	118.5	115.2	16	DM*160 - DM*169
TIDC170C17-3	17 - 17.9	17	54	48	119.7	120.7	117.2	17	DM*170 - DM*179
TIDC180C18-3	18 - 18.9	18	57	48	123.3	124.4	120.5	18	DM*180 - DM*189
TIDC190C19-3	19 - 19.9	19	61	54	132.4	133.5	129.4	19	DM*190 - DM*199

Tool diameter (mm)	Hole diameter tolerance (mm)*
ø7.5 - ø17.9	+0.04 / 0
ø18 - ø19.9	+0.045 / 0

\*Just for reference

- An overall length (OAL) differs based on each head geometry.
- When using the drill at a higher feed rate, make sure to provide an axial support by placing the overhang adjusting screw at the drill shank end in the tool holder. This will prevent high thrust force from pushing the drill back into the holder during drilling.
- For drill diameters from ø8 - ø9.9 mm, the drill shoulder to shank bottom distance when a DMC drill head is mounted is 0.3 mm shorter when compared with a DMP head of the equivalent sizes. The distances are the same for the DMC and DMP drill heads in other diameters than the above.
- When axially adjusting the shank inside the holder to obtain a required drill overhang, make sure the shank length remaining inside the holder does not come short of the minimum clamping length (LSCN) specified by the holder supplier.

## SPARE PARTS



Designation	Clamping key
TIDC075... - TIDC099...	K-TID6-9.99
TIDC100... - TIDC190...	K-TID10-19.99

Reference pages: Head → **J029 - J036**  
Standard cutting conditions → **J037**

# DRILLMEISTER

## TID-R L/D=3.5

Exchangeable head drill, L/D = 3.5, Cylindrical shank

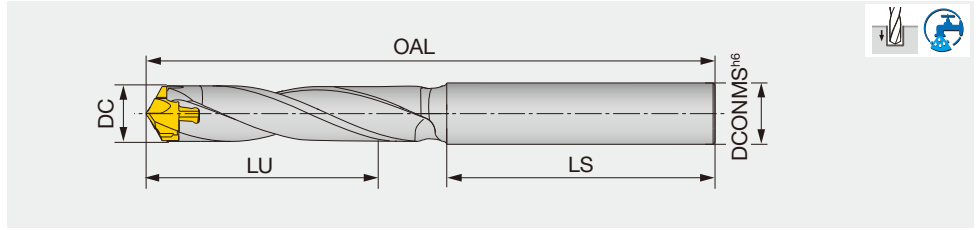

Metric	DC	DCONMS	LU	LS	OAL			Pocket size	Head
					DMP/H/N	DMC	DMF		
TID060R8-3.5	6 - 6.4	8	21	45	75.6	75.8	74.8	6	DM*060 - DM*064
TID065R8-3.5	6.5 - 6.9	8	23	45	77.5	77.6	76.6	6.5	DM*065 - DM*069
TID070R8-3.5	7 - 7.4	8	25	45	79.1	79.5	78.2	7	DM*070 - DM*074
TID075R8-3.5	7.5 - 7.9	8	26	45	80.8	81.3	80	7	DM*075 - DM*079
TID080R10-3.5	8 - 8.4	10	28	50	87.8	87.9	86.9	8	DM*080 - DM*084
TID085R10-3.5	8.5 - 8.9	10	30	50	89.5	89.7	88.6	8	DM*085 - DM*089
TID090R10-3.5	9 - 9.4	10	32	50	91.4	91.6	90.4	9	DM*090 - DM*094
TID095R10-3.5	9.5 - 9.9	10	33	50	93.2	93.3	92.1	9	DM*095 - DM*099
TID100R12-3.5	10 - 10.4	12	42	60	114	114.7	112.7	10	DM*100 - DM*104
TID105R12-3.5	10.5 - 10.9	12	44	60	115.7	116.3	114.4	10	DM*105 - DM*109
TID110R12-3.5	11 - 11.4	12	46	65	123.1	123.8	121.6	11	DM*110 - DM*114
TID115R12-3.5	11.5 - 11.9	12	48	65	124.8	125.4	123.2	11	DM*115 - DM*119
TID120R14-3.5	12 - 12.4	14	50	65	127.2	127.8	125.6	12	DM*120 - DM*124
TID125R14-3.5	12.5 - 12.9	14	52	65	128.8	129.5	127.3	12	DM*125 - DM*129
TID130R14-3.5	13 - 13.4	14	54	65	132.7	133.5	130.9	13	DM*130 - DM*134
TID135R14-3.5	13.5 - 13.9	14	56	65	134.4	135.2	132.5	13	DM*135 - DM*139
TID140R16-3.5	14 - 14.4	16	58	70	142.2	143	140.2	14	DM*140 - DM*144
TID145R16-3.5	14.5 - 14.9	16	60	70	143.8	144.7	141.9	14	DM*145 - DM*149
TID150R16-3.5	15 - 15.9	16	64	70	148.4	149.4	146.3	15	DM*150 - DM*159
TID160R18-3.5	16 - 16.9	18	68	70	153.9	154.9	151.7	16	DM*160 - DM*169
TID170R18-3.5	17 - 17.9	18	72	70	158.5	159.4	155.9	17	DM*170 - DM*179
TID180R20-3.5	18 - 18.9	20	76	70	164	165.1	161.2	18	DM*180 - DM*189
TID190R20-3.5	19 - 19.9	20	80	70	168.4	169.5	165.4	19	DM*190 - DM*199

Tool diameter (mm)	Hole diameter tolerance (mm)*
ø6 - ø19.9	+0.04 / 0

\*Just for reference

- An overall length (OAL) differs based on each head geometry.
- When using the drill at a higher feed rate, make sure to provide an axial support by placing the overhang adjusting screw at the drill shank end in the tool holder. This will prevent high thrust force from pushing the drill back into the holder during drilling.
- When axially adjusting the shank inside the holder to obtain a required drill overhang, make sure the shank length remaining inside the holder does not come short of the minimum clamping length (LSCN) specified by the holder supplier.
- For drill diameters from ø8 - ø9.9 mm, the drill shoulder to shank bottom distance when a DMC drill head is mounted is 0.3 mm shorter when compared with a DMP head of the equivalent sizes. The distances are the same for the DMC and DMP drill heads in other diameters than the above.

### SPARE PARTS

Designation	Clamping key
TID060... - TID095...	K-TID6-9.99
TID100... - TID190...	K-TID10-19.99

Reference pages: Head → **J029 - J036**  
Standard cutting conditions → **J037**

# TIDU-F L/D=5

Exchangeable head drill, L/D = 5, flange type

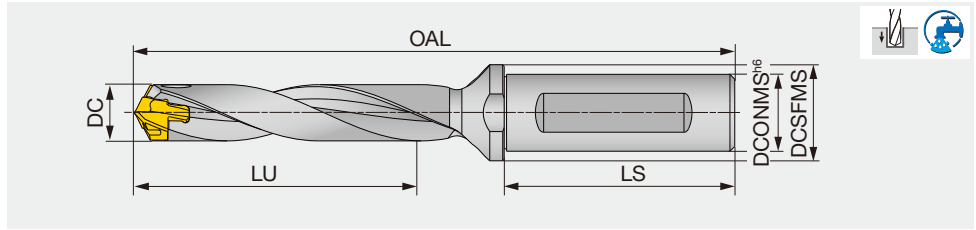

Inch	DC	DCONMS	DCSFMS	LU	LS	OAL			Pocket size	Head
						DMP/H/N	DMC	DMF		
TIDU0394F0625-5	0.394 - 0.409	0.625	0.787	1.969	1.890	4.496	4.514	3.465	10	DM*100 - DM*104
TIDU0413F0625-5	0.413 - 0.429	0.625	0.787	2.087	1.890	4.594	4.618	3.574	10	DM*105 - DM*109
TIDU0433F0625-5	0.433 - 0.449	0.625	0.787	2.165	1.890	4.709	4.733	3.684	11	DM*110 - DM*114
TIDU0453F0625-5	0.453 - 0.469	0.625	0.787	2.283	1.890	4.807	4.831	3.783	11	DM*115 - DM*119
TIDU0472F0625-5	0.472 - 0.488	0.625	0.787	2.362	1.890	4.921	4.945	3.913	12	DM*120 - DM*124
TIDU0492F0625-5	0.492 - 0.508	0.625	0.787	2.441	1.890	5.020	5.044	4.011	12	DM*125 - DM*129
TIDU0512F0625-5	0.512 - 0.528	0.625	0.787	2.559	1.890	5.142	5.173	4.119	13	DM*130 - DM*134
TIDU0532F0625-5	0.532 - 0.547	0.625	0.787	2.677	1.890	5.240	5.271	4.217	13	DM*135 - DM*139
TIDU0551F0625-5	0.551 - 0.567	0.625	0.787	2.756	1.890	5.440	5.471	4.438	14	DM*140 - DM*144
TIDU0571F0625-5	0.571 - 0.587	0.625	0.787	2.874	1.890	5.539	5.570	4.536	14	DM*145 - DM*149
TIDU0591F0750-5	0.591 - 0.626	0.750	0.984	2.953	1.969	5.854	5.889	4.642	15	DM*150 - DM*159
TIDU0630F0750-5	0.630 - 0.665	0.750	0.984	3.150	1.969	6.114	6.153	4.740	16	DM*160 - DM*169
TIDU0669F0750-5	0.669 - 0.705	0.750	0.984	3.346	1.969	6.374	6.413	4.851	17	DM*170 - DM*179
TIDU0709F1000-5	0.709 - 0.744	1.000	1.260	3.543	2.205	6.870	6.913	4.949	18	DM*180 - DM*189
TIDU0748F1000-5	0.748 - 0.783	1.000	1.260	3.740	2.205	7.126	7.169	5.060	19	DM*190 - DM*199
TIDU0787F1000-5	0.787 - 0.823	1.000	1.260	3.937	2.205	7.386	7.432	5.159	20	DMP200 - DMP209
TIDU0827F1000-5	0.827 - 0.862	1.000	1.260	4.134	2.205	7.646	7.694	5.353	21	DMP210 - DMP219
TIDU0866F1000-5	0.866 - 0.902	1.000	1.260	4.331	2.205	7.906	7.956	5.451	22	DMP220 - DMP229
TIDU0906F1250-5	0.906 - 0.941	1.250	1.654	4.528	2.362	8.319	8.373	5.765	23	DMP230 - DMP239
TIDU0945F1250-5	0.945 - 0.980	1.250	1.654	4.724	2.362	8.579	8.634	6.017	24	DMP240 - DMP249
TIDU0984F1250-5	0.984 - 1.020	1.250	1.654	4.921	2.362	8.839	8.898	6.266	25	DMP250 - DMP259

Tool diameter (in)	Hole diameter tolerance (in)*
ø0.394" - ø1.020"	+0.0020" / 0

\*Just for reference

- An overall length (OAL) differs for when the DMP insert is mounted and when the DMC is mounted. (No difference for the drill shoulder)  
 - For drill diameters from ø0.315"- ø0.390", the drill shoulder to shank bottom distance when a DMC drill head is mounted is 0.012" shorter when compared with a DMP head of the equivalent sizes. The distances are the same for the DMC and DMP drill heads in other diameters than the above.

## SPARE PARTS

Designation	Clamping key
TIDU0394 - TIDU0748	K-TID10-19.99
TIDU0787 - TIDU0984	K-TID20-26.99

Reference pages: Head → **J029 - J036**  
 Standard cutting conditions → **J037**

# DRILLMEISTER

## TID L/D=5

Exchangeable head drill, L/D = 5, flange type

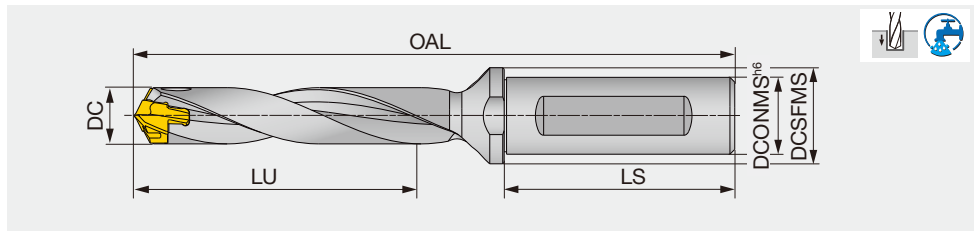

Metric	DC	DCONMS	DCSFMS	LU	LS	OAL			Pocket size	Head
						DMP/H/N	DMC	DMF		
TID060F12-5	6 - 6.4	12	16	31	45	88.9	89	88	6	DM*060 - DM*064
TID065F12-5	6.5 - 6.9	12	16	34	45	91.7	91.8	90.8	6.5	DM*065 - DM*069
TID070F12-5	7 - 7.4	12	16	36	45	94.5	94.9	93.6	7	DM*070 - DM*074
TID075F12-5	7.5 - 7.9	12	16	39	45	97	97.4	96.1	7	DM*075 - DM*079
TID080F12-5	8 - 8.4	12	16	42	45	100.3	100.4	99.4	8	DM*080 - DM*084
TID085F12-5	8.5 - 8.9	12	16	45	45	102.8	102.9	101.9	8	DM*085 - DM*089
TID090F12-5	9 - 9.4	12	16	47	45	105.7	105.8	104.6	9	DM*090 - DM*094
TID095F12-5	9.5 - 9.9	12	16	50	45	108.2	108.3	107.1	9	DM*095 - DM*099
TID100F16-5	10 - 10.4	16	20	52	48	114.1	114.7	112.7	10	DM*100 - DM*104
TID105F16-5	10.5 - 10.9	16	20	55	48	116.6	117.2	115.2	10	DM*105 - DM*109
TID110F16-5	11 - 11.4	16	20	57	48	119.5	120.1	117.9	11	DM*110 - DM*114
TID115F16-5	11.5 - 11.9	16	20	60	48	122	122.6	120.4	11	DM*115 - DM*119
TID120F16-5	12 - 12.4	16	20	62	48	124.8	125.4	123.2	12	DM*120 - DM*124
TID125F16-5	12.5 - 12.9	16	20	64	48	127.3	127.9	125.7	12	DM*125 - DM*129
TID130F16-5	13 - 13.4	16	20	67	48	130.4	131.2	128.5	13	DM*130 - DM*134
TID135F16-5	13.5 - 13.9	16	20	71	48	132.9	133.7	131	13	DM*135 - DM*139
TID140F16-5	14 - 14.4	16	20	73	48	138	138.8	136	14	DM*140 - DM*144
TID145F16-5	14.5 - 14.9	16	20	76	48	140.5	141.3	138.5	14	DM*145 - DM*149
TID150F20-5	15 - 15.9	20	25	78	50	148.5	149.4	146.4	15	DM*150 - DM*159
TID160F20-5	16 - 16.9	20	25	83	50	155.1	156.1	152.8	16	DM*160 - DM*169
TID170F20-5	17 - 17.9	20	25	88	50	161.7	162.7	159.2	17	DM*170 - DM*179
TID180F25-5	18 - 18.9	25	32	93	56	174.3	175.4	171.5	18	DM*180 - DM*189
TID190F25-5	19 - 19.9	25	32	99	56	180.8	181.9	177.8	19	DM*190 - DM*199
TID200F25-5	20 - 20.9	25	32	104	56	187.6	188.8	185.3	20	DM*200 - DM*209
TID210F25-5	21 - 21.9	25	32	109	56	194.2	195.4	191.8	21	DM*210 - DM*219
TID220F25-5	22 - 22.9	25	32	114	56	200.8	202.1	198.1	22	DM*220 - DM*229
TID230F32-5	23 - 23.9	32	42	119	60	211.3	212.7	208.5	23	DM*230 - DM*239
TID240F32-5	24 - 24.9	32	42	124	60	217.9	219.3	214.9	24	DM*240 - DM*249
TID250F32-5	25 - 25.9	32	42	130	60	224.5	226	221.4	25	DM*250 - DM*259

Tool diameter (mm)	Hole diameter tolerance (mm)*
ø6 - ø25.9	+0.05 / 0

- An overall length (OAL) differs based on each head geometry.  
 - For drill diameters from ø8 - ø9.9 mm, the drill shoulder to shank bottom distance when a DMC drill head is mounted is 0.3 mm shorter when compared with a DMP head of the equivalent sizes. The distances are the same for the DMC and DMP drill heads in other diameters than the above.

\*Just for reference

### SPARE PARTS



Designation	Clamping key
TID060... - TID095...	K-TID6-9.99
TID100... - TID190...	K-TID10-19.99
TID200... - TID250...	K-TID20-26.99

Reference pages: Head → **J029 - J036**  
 Standard cutting conditions → **J037**



## TIDC L/D=5

Exchangeable head drill, L/D = 5, Cylindrical shank, for chamfering adapter

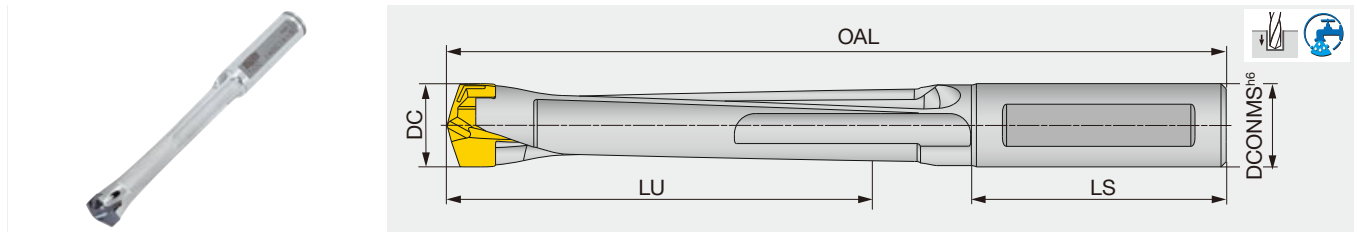

Metric	DC	DCONMS	LU	LS	OAL			Pocket size	Head
					DMP/H/N	DMC	DMF		
TIDC075C8-5	7.5 - 7.9	8	38	36	85.1	85.6	84.2	7	DM*075 - DM*079
TIDC080C8-5	8 - 8.4	8	40	36	92.3	92.5	91.4	8	DM*080 - DM*084
TIDC085C9-5	8.5 - 8.9	9	43	36	89.8	90	88.9	8	DM*085 - DM*089
TIDC090C9-5	9 - 9.4	9	45	36	92.7	92.9	91.7	9	DM*090 - DM*094
TIDC095C10-5	9.5 - 9.9	10	48	36	95.2	95.4	94.2	9	DM*095 - DM*099
TIDC100C10-5	10 - 10.4	10	52	41	106.1	106.7	104.8	10	DM*100 - DM*104
TIDC105C11-5	10.5 - 10.9	11	54	41	108.6	109.2	107.3	10	DM*105 - DM*109
TIDC110C11-5	11 - 11.4	11	57	41	111.5	112.2	110	11	DM*110 - DM*114
TIDC115C12-5	11.5 - 11.9	12	60	41	114	114.7	112.5	11	DM*115 - DM*119
TIDC120C12-5	12 - 12.4	12	62	41	116.8	117.4	115.2	12	DM*120 - DM*124
TIDC125C13-5	12.5 - 12.9	13	65	46	124.3	124.9	122.7	12	DM*125 - DM*129
TIDC130C13-5	13 - 13.4	13	67	47	128.4	129.2	126.5	13	DM*130 - DM*134
TIDC135C14-5	13.5 - 13.9	14	70	43	126.9	127.7	125	13	DM*135 - DM*139
TIDC140C14-5	14 - 14.4	14	73	44	131	131.8	129	14	DM*140 - DM*144
TIDC145C15-5	14.5 - 14.9	15	75	45	134.5	135.3	132.5	14	DM*145 - DM*149
TIDC150C15-5	15 - 15.9	15	78	45	137.5	138.4	135.4	15	DM*150 - DM*159
TIDC160C16-5	16 - 16.9	16	83	48	149.5	150.5	147.2	16	DM*160 - DM*169
TIDC170C17-5	17 - 17.9	17	88	48	153.7	154.7	151.2	17	DM*170 - DM*179
TIDC180C18-5	18 - 18.9	18	93	48	159.3	160.4	156.5	18	DM*180 - DM*189
TIDC190C19-5	19 - 19.9	19	99	54	170.4	171.5	167.4	19	DM*190 - DM*199

Tool diameter (mm)	Hole diameter tolerance (mm)*
ø7.5 - ø19.9	+0.05 / 0

\*Just for reference

- An overall length (OAL) differs based on each head geometry.
- When using the drill at a higher feed rate, make sure to provide an axial support by placing the overhang adjusting screw at the drill shank end in the tool holder. This will prevent high thrust force from pushing the drill back into the holder during drilling.
- For drill diameters from ø8 - ø9.9 mm, the drill shoulder to shank bottom distance when a DMC drill head is mounted is 0.3 mm shorter when compared with a DMP head of the equivalent sizes. The distances are the same for the DMC and DMP drill heads in other diameters than the above.
- When axially adjusting the shank inside the holder to obtain a required drill overhang, make sure the shank length remaining inside the holder does not come short of the minimum clamping length (LSCN) specified by the holder supplier.

### SPARE PARTS

Designation	Clamping key
TIDC075... - TIDC099...	K-TID6-9.99
TIDC100... - TIDC190...	K-TID10-19.99

Reference pages: Head → **J029 - J036**  
Standard cutting conditions → **J037**



# DRILLMEISTER

## TID-R L/D=6

Exchangeable head drill, L/D = 6, Cylindrical shank

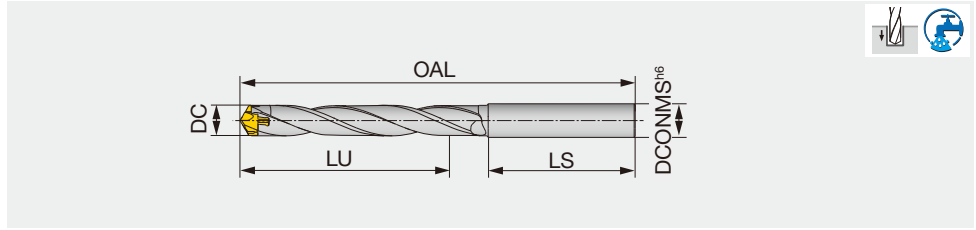

Metric	DC	DCONMS	LU	LS	OAL			Pocket size	Head
					DMP/H/N	DMC	DMF		
TID060R8-6	6 - 6.4	8	36	45	91.6	91.8	90.8	6	DM*060 - DM*064
TID065R8-6	6.5 - 6.9	8	39	45	94.7	94.9	93.9	6.5	DM*065 - DM*069
TID070R8-6	7 - 7.4	8	42	45	97.6	98	96.7	7	DM*070 - DM*074
TID075R8-6	7.5 - 7.9	8	45	45	100.6	101	99.7	7	DM*075 - DM*079
TID080R10-6	8 - 8.4	10	48	50	108.8	108.9	107.9	8	DM*080 - DM*084
TID085R10-6	8.5 - 8.9	10	51	50	111.8	111.9	110.9	8	DM*085 - DM*089
TID090R10-6	9 - 9.4	10	54	50	114.9	115.1	113.9	9	DM*090 - DM*094
TID095R10-6	9.5 - 9.9	10	57	50	117.9	118.1	116.9	9	DM*095 - DM*099
TID100R12-6	10 - 10.4	12	68	60	140	140.7	138.7	10	DM*100 - DM*104
TID105R12-6	10.5 - 10.9	12	71	60	142.9	143.6	141.6	10	DM*105 - DM*109
TID110R12-6	11 - 11.4	12	75	65	151.6	152.3	150.1	11	DM*110 - DM*114
TID115R12-6	11.5 - 11.9	12	78	65	154.5	155.2	153	11	DM*115 - DM*119
TID120R14-6	12 - 12.4	14	81	65	158.2	158.8	156.6	12	DM*120 - DM*124
TID125R14-6	12.5 - 12.9	14	84	65	161.1	161.7	159.5	12	DM*125 - DM*129
TID130R14-6	13 - 13.4	14	88	65	166.2	167	164.4	13	DM*130 - DM*134
TID135R14-6	13.5 - 13.9	14	91	65	169.2	169.9	167.3	13	DM*135 - DM*139
TID140R16-6	14 - 14.4	16	94	70	178.2	179	176.2	14	DM*140 - DM*144
TID145R16-6	14.5 - 14.9	16	97	70	181.1	181.9	179.1	14	DM*145 - DM*149
TID150R16-6	15 - 15.9	16	104	70	188.2	189.1	186.1	15	DM*150 - DM*159
TID160R18-6	16 - 16.9	18	110	70	196.2	197.2	193.9	16	DM*160 - DM*169
TID170R18-6	17 - 17.9	18	117	70	203.2	204.2	200.7	17	DM*170 - DM*179
TID180R20-6	18 - 18.9	20	124	70	211.3	212.3	208.4	18	DM*180 - DM*189
TID190R20-6	19 - 19.9	20	130	70	218.1	219.2	215.1	19	DM*190 - DM*199

Tool diameter (mm)	Hole diameter tolerance (mm)*
ø6 - ø17.9	+0.05 / 0
ø18 - ø19.9	+0.055 / 0

\*Just for reference

- An overall length (OAL) differs based on each head geometry.
- When using the drill at a higher feed rate, make sure to provide an axial support by placing the overhang adjusting screw at the drill shank end in the tool holder. This will prevent high thrust force from pushing the drill back into the holder during drilling.
- When axially adjusting the shank inside the holder to obtain a required drill overhang, make sure the shank length remaining inside the holder does not come short of the minimum clamping length (LSCN) specified by the holder supplier.
- For drill diameters from ø8 - ø9.9 mm, the drill shoulder to shank bottom distance when a DMC drill head is mounted is 0.3 mm shorter when compared with a DMP head of the equivalent sizes. The distances are the same for the DMC and DMP drill heads in other diameters than the above.

### SPARE PARTS

Designation	Clamping key
TID060... - TID095...	K-TID6-9.99
TID100... - TID190...	K-TID10-19.99

Reference pages: Head → **J029 - J036**  
Standard cutting conditions → **J037**

# TIDU-F L/D=8

Exchangeable head drill, L/D = 8, flange type

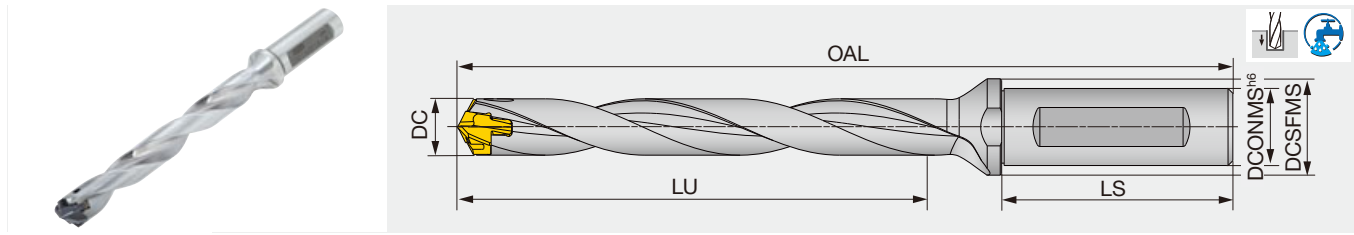

Inch	DC	DCONMS	DCSFMS	LU	LS	OAL			Pocket size	Head
						DMP/H/N	DMC	DMF		
TIDU0394F0625-8	0.394 - 0.409	0.625	0.787	3.150	1.890	5.677	5.701	4.511	10	DM*100 - DM*104
TIDU0413F0625-8	0.413 - 0.429	0.625	0.787	3.307	1.890	5.835	5.859	4.669	10	DM*105 - DM*109
TIDU0433F0625-8	0.433 - 0.449	0.625	0.787	3.465	1.890	6.008	6.032	4.858	11	DM*110 - DM*114
TIDU0453F0625-8	0.453 - 0.469	0.625	0.787	3.622	1.890	6.165	6.189	5.015	11	DM*115 - DM*119
TIDU0472F0625-8	0.472 - 0.488	0.625	0.787	3.780	1.890	6.339	6.363	5.181	12	DM*120 - DM*124
TIDU0492F0625-8	0.492 - 0.508	0.625	0.787	3.937	1.890	6.496	6.52	5.339	12	DM*125 - DM*129
TIDU0512F0625-8	0.512 - 0.528	0.625	0.787	4.094	1.890	6.677	6.708	5.619	13	DM*130 - DM*134
TIDU0532F0625-8	0.532 - 0.547	0.625	0.787	4.252	1.890	6.835	6.866	5.776	13	DM*135 - DM*139
TIDU0551F0625-8	0.551 - 0.567	0.625	0.787	4.409	1.890	7.091	7.122	5.941	14	DM*140 - DM*144
TIDU0571F0625-8	0.571 - 0.587	0.625	0.787	4.567	1.890	7.252	7.283	6.098	14	DM*145 - DM*149
TIDU0591F0750-8	0.591 - 0.626	0.750	0.984	4.724	1.969	7.626	7.661	6.268	15	DM*150 - DM*159
TIDU0630F0750-8	0.630 - 0.665	0.750	0.984	5.039	1.969	8.004	8.043	6.426	16	DM*160 - DM*169
TIDU0669F0750-8	0.669 - 0.705	0.750	0.984	5.354	1.969	8.382	8.421	6.596	17	DM*170 - DM*179
TIDU0709F1000-8	0.709 - 0.744	1.000	1.260	5.669	2.205	8.996	9.039	6.753	18	DM*180 - DM*189
TIDU0748F1000-8	0.748 - 0.783	1.000	1.260	5.984	2.205	9.370	9.413	7.006	19	DM*190 - DM*199
TIDU0787F1000-8	0.787 - 0.823	1.000	1.260	6.299	2.205	9.748	9.795	7.164	20	DMP200 - DMP209
TIDU0827F1000-8	0.827 - 0.862	1.000	1.260	6.614	2.205	10.126	10.174	7.537	21	DMP210 - DMP219
TIDU0866F1000-8	0.866 - 0.902	1.000	1.260	6.929	2.205	10.504	10.554	7.907	22	DMP220 - DMP229
TIDU0906F1250-8	0.906 - 0.941	1.250	1.654	7.244	2.362	11.035	11.089	8.274	23	DMP230 - DMP239
TIDU0945F1250-8	0.945 - 0.980	1.250	1.654	7.559	2.362	11.413	11.468	8.876	24	DMP240 - DMP249
TIDU0984F1250-8	0.984 - 1.020	1.250	1.654	7.874	2.362	11.791	11.850	9.244	25	DMP250 - DMP259

Tool diameter (in)	Hole diameter tolerance (in)*
ø0.394" - ø0.705"	+0.0020" / 0
ø0.709" - ø1.020"	+0.0022" / 0

- An overall length (OAL) differs for when the DMP insert is mounted and when the DMC is mounted. (No difference for the drill shoulder)  
 - For drill diameters from ø0.315" - ø0.390", the drill shoulder to shank bottom distance when a DMC drill head is mounted is 0.012" shorter when compared with a DMP head of the equivalent sizes. The distances are the same for the DMC and DMP drill heads in other diameters than the above.

\*Just for reference

## SPARE PARTS



Designation	Clamping key
TIDU0394 - TIDU0748	K-TID10-19.99
TIDU0787 - TIDU0984	K-TID20-26.99

Reference pages: Head → **J029 - J036**  
 Standard cutting conditions → **J037**



# DRILLMEISTER

## TID L/D=8

Exchangeable head drill, L/D = 8, flange type

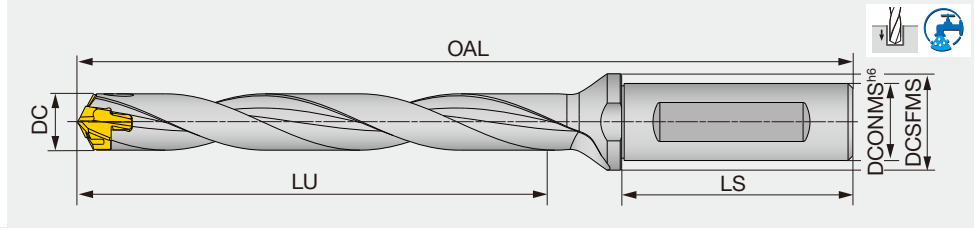

Metric	DC	DCONMS	DCSFMS	LU	LS	OAL			Pocket size	Head
						DMP/H/N	DMC	DMF		
TID070F12-8	7 - 7.4	12	16	57	45	115.5	115.9	114.6	7	DM*070 - DM*074
TID075F12-8	7.5 - 7.9	12	16	61	45	119.5	119.9	118.6	7	DM*075 - DM*079
TID080F12-8	8 - 8.4	12	16	66	45	124.3	124.4	123.4	8	DM*080 - DM*084
TID085F12-8	8.5 - 8.9	12	16	70	45	128.3	128.4	127.4	8	DM*085 - DM*089
TID090F12-8	9 - 9.4	12	16	74	45	132.7	132.8	131.6	9	DM*090 - DM*094
TID095F12-8	9.5 - 9.9	12	16	78	45	136.7	136.8	135.6	9	DM*095 - DM*099
TID100F16-8	10 - 10.4	16	20	82	48	144.1	144.7	142.7	10	DM*100 - DM*104
TID105F16-8	10.5 - 10.9	16	20	86	48	148.1	148.7	146.7	10	DM*105 - DM*109
TID110F16-8	11 - 11.4	16	20	90	48	152.5	153.1	150.9	11	DM*110 - DM*114
TID115F16-8	11.5 - 11.9	16	20	94	48	156.5	157.1	154.9	11	DM*115 - DM*119
TID120F16-8	12 - 12.4	16	20	98	48	160.8	161.4	159.2	12	DM*120 - DM*124
TID125F16-8	12.5 - 12.9	16	20	102	48	164.8	165.4	163.2	12	DM*125 - DM*129
TID130F16-8	13 - 13.4	16	20	106	48	169.4	170.2	167.5	13	DM*130 - DM*134
TID135F16-8	13.5 - 13.9	16	20	111	48	173.4	174.2	171.5	13	DM*135 - DM*139
TID140F16-8	14 - 14.4	16	20	115	48	180	180.8	178	14	DM*140 - DM*144
TID145F16-8	14.5 - 14.9	16	20	119	48	184	184.8	182	14	DM*145 - DM*149
TID150F20-8	15 - 15.9	20	25	123	50	193.5	194.4	191.4	15	DM*150 - DM*159
TID160F20-8	16 - 16.9	20	25	131	50	203.1	204.1	200.8	16	DM*160 - DM*169
TID170F20-8	17 - 17.9	20	25	139	50	212.7	213.7	210.2	17	DM*170 - DM*179
TID180F25-8	18 - 18.9	25	32	147	56	228.3	229.4	225.5	18	DM*180 - DM*189
TID190F25-8	19 - 19.9	25	32	156	56	237.8	238.9	234.8	19	DM*190 - DM*199
TID200F25-8	20 - 20.9	25	32	164	56	247.4	248.6	245.1	20	DM*200 - DM*209
TID210F25-8	21 - 21.9	25	32	172	56	257	258.2	254.5	21	DM*210 - DM*219
TID220F25-8	22 - 22.9	25	32	180	56	266.6	267.8	263.9	22	DM*220 - DM*229
TID230F32-8	23 - 23.9	32	42	188	60	280.1	281.5	277.3	23	DM*230 - DM*239
TID240F32-8	24 - 24.9	32	42	196	60	289.7	291.1	286.7	24	DM*240 - DM*249
TID250F32-8	25 - 25.9	32	42	205	60	299.3	300.8	296.2	25	DM*250 - DM*259

Tool diameter (mm)	Hole diameter tolerance (mm)*
ø7 - ø17.9	+0.05 / 0
ø18 - ø25.9	+0.055 / 0

- An overall length (OAL) differs based on each head geometry.  
 - For drill diameters from ø8 - ø9.9 mm, the drill shoulder to shank bottom distance when a DMC drill head is mounted is 0.3 mm shorter when compared with a DMP head of the equivalent sizes. The distances are the same for the DMC and DMP drill heads in other diameters than the above.

\*Just for reference



### SPARE PARTS

Designation	Clamping key
TID070... - TID095...	K-TID6-9.99
TID100... - TID190...	K-TID10-19.99
TID200... - TID250...	K-TID20-26.99

Reference pages: Head → **J029 - J036**  
 Standard cutting conditions → **J037**

# TID-R L/D=8

Exchangeable head drill, L/D = 8, Cylindrical shank

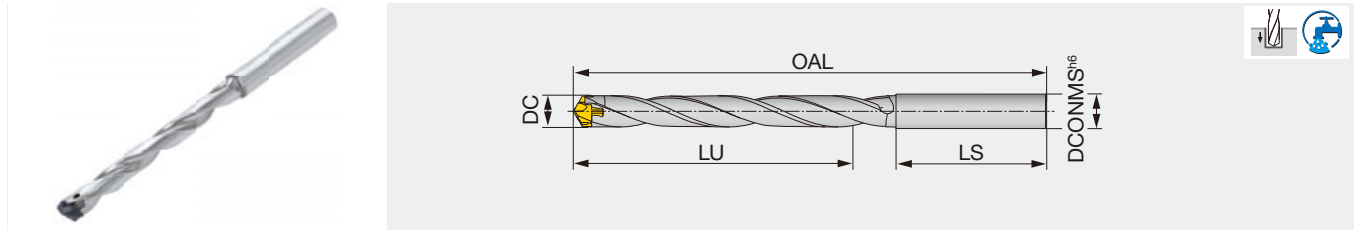

Metric	DC	DCONMS	LU	LS	OAL			Pocket size	Head
					DMP/H/N	DMC	DMF		
TID060R8-8	6 - 6.4	8	48	45	104.4	104.6	103.6	6	DM*060 - DM*064
TID065R8-8	6.5 - 6.9	8	52	45	108.5	108.7	107.7	6.5	DM*065 - DM*069
TID070R8-8	7 - 7.4	8	56	45	112.4	112.8	111.5	7	DM*070 - DM*074
TID075R8-8	7.5 - 7.9	8	60	45	116.4	116.8	115.5	7	DM*075 - DM*079
TID080R10-8	8 - 8.4	10	64	50	125.6	125.7	124.7	8	DM*080 - DM*084
TID085R10-8	8.5 - 8.9	10	68	50	129.6	129.7	128.7	8	DM*085 - DM*089
TID090R10-8	9 - 9.4	10	72	50	133.7	133.9	132.7	9	DM*090 - DM*094
TID095R10-8	9.5 - 9.9	10	76	50	137.7	137.9	136.7	9	DM*095 - DM*099
TID100R12-8	10 - 10.4	12	89	60	160.8	161.5	159.5	10	DM*100 - DM*104
TID105R12-8	10.5 - 10.9	12	93	60	164.7	165.4	163.4	10	DM*105 - DM*109
TID110R12-8	11 - 11.4	12	98	65	174.4	175.1	172.9	11	DM*110 - DM*114
TID115R12-8	11.5 - 11.9	12	102	65	178.3	179	176.8	11	DM*115 - DM*119
TID120R14-8	12 - 12.4	14	106	65	183	183.6	181.4	12	DM*120 - DM*124
TID125R14-8	12.5 - 12.9	14	110	65	186.9	187.5	185.3	12	DM*125 - DM*129
TID130R14-8	13 - 13.4	14	115	65	193	193.8	191.2	13	DM*130 - DM*134
TID135R14-8	13.5 - 13.9	14	119	65	196.9	197.7	195	13	DM*135 - DM*139
TID140R16-8	14 - 14.4	16	123	70	207	207.8	205	14	DM*140 - DM*144
TID145R16-8	14.5 - 14.9	16	127	70	210.9	211.7	208.9	14	DM*145 - DM*149
TID150R16-8	15 - 15.9	16	136	70	220	220.9	217.9	15	DM*150 - DM*159
TID160R18-8	16 - 16.9	18	144	70	230	231	227.7	16	DM*160 - DM*169
TID170R18-8	17 - 17.9	18	153	70	239	240	236.5	17	DM*170 - DM*179
TID180R20-8	18 - 18.9	20	162	70	249.1	250.1	246.2	18	DM*180 - DM*189
TID190R20-8	19 - 19.9	20	170	70	257.9	259	254.9	19	DM*190 - DM*199

Tool diameter (mm)	Hole diameter tolerance (mm)*
ø6 - ø17.9	+0.05 / 0
ø18 - ø19.9	+0.055 / 0

\*Just for reference

- An overall length (OAL) differs based on each head geometry.
- When using the drill at a higher feed rate, make sure to provide an axial support by placing the overhang adjusting screw at the drill shank end in the tool holder. This will prevent high thrust force from pushing the drill back into the holder during drilling.
- When axially adjusting the shank inside the holder to obtain a required drill overhang, make sure the shank length remaining inside the holder does not come short of the minimum clamping length (LSCN) specified by the holder supplier.
- For drill diameters from ø8 - ø9.9 mm, the drill shoulder to shank bottom distance when a DMC drill head is mounted is 0.3 mm shorter when compared with a DMP head of the equivalent sizes. The distances are the same for the DMC and DMP drill heads in other diameters than the above.

## SPARE PARTS



Designation	Clamping key
TID060... - TID095...	K-TID6-9.99
TID100... - TID190...	K-TID10-19.99

Reference pages: Head → **J029 - J036**  
Standard cutting conditions → **J037**

# DRILLMEISTER

## TID L/D=12

Exchangeable head drill, L/D = 12, Cylindrical shank

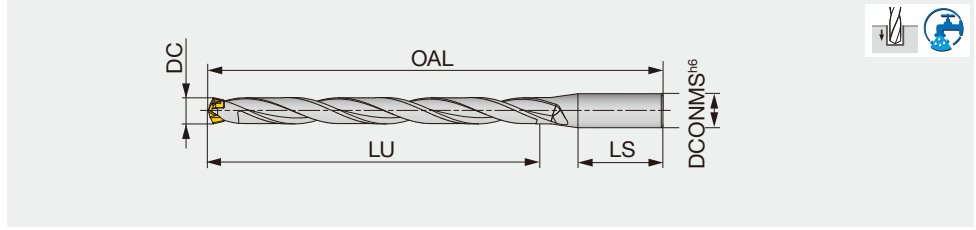

Metric	DC	DCONMS	LU	LS	OAL			Pocket size	Head
					DMP/H/N	DMC	DMF		
TID080R12-12	8 - 8.4	12	98	45	156.3	156.4	155.4	8	DM*080 - DM*084
TID085R12-12	8.5 - 8.9	12	104	45	162.3	162.4	161.4	8	DM*085 - DM*089
TID090R12-12	9 - 9.4	12	110	45	168.7	168.8	167.6	9	DM*090 - DM*094
TID095R12-12	9.5 - 9.9	12	116	45	174.7	174.8	173.6	9	DM*095 - DM*099
TID100R16-12	10 - 10.4	16	122	48	184.1	184.7	182.7	10	DM*100 - DM*104
TID105R16-12	10.5 - 10.9	16	128	48	190.1	190.7	188.7	10	DM*105 - DM*109
TID110R16-12	11 - 11.4	16	134	48	196.5	197.1	194.9	11	DM*110 - DM*114
TID115R16-12	11.5 - 11.9	16	140	48	202.5	203.1	200.9	11	DM*115 - DM*119
TID120R16-12	12 - 12.4	16	146	48	208.8	209.4	207.2	12	DM*120 - DM*124
TID125R16-12	12.5 - 12.9	16	152	48	214.8	215.4	213.2	12	DM*125 - DM*129
TID130R16-12	13 - 13.4	16	158	48	221.4	222.2	219.5	13	DM*130 - DM*134
TID135R16-12	13.5 - 13.9	16	165	48	227.4	228.2	225.5	13	DM*135 - DM*139
TID140R16-12	14 - 14.4	16	171	48	236	236.8	234	14	DM*140 - DM*144
TID145R16-12	14.5 - 14.9	16	177	48	242	242.8	240	14	DM*145 - DM*149
TID150R20-12	15 - 15.9	20	183	50	253.5	254.4	251.4	15	DM*150 - DM*159
TID160R20-12	16 - 16.9	20	195	50	267.1	268.1	264.8	16	DM*160 - DM*169
TID170R20-12	17 - 17.9	20	207	50	280.7	281.7	278.2	17	DM*170 - DM*179
TID180R25-12	18 - 18.9	25	219	56	300.3	301.4	297.5	18	DM*180 - DM*189
TID190R25-12	19 - 19.9	25	232	56	313.8	314.9	310.8	19	DM*190 - DM*199
TID200R25-12	20 - 20.9	25	244	56	327.4	328.6	325.1	20	DM*200 - DM*209
TID210R25-12	21 - 21.9	25	256	56	341	342.2	338.5	21	DM*210 - DM*219
TID220R25-12	22 - 22.9	25	267	56	354.6	355.8	351.9	22	DM*220 - DM*229
TID230R32-12	23 - 23.9	32	276	60	372.1	373.5	369.3	23	DM*230 - DM*239
TID240R32-12	24 - 24.9	32	288	60	385.7	387.1	382.7	24	DM*240 - DM*249
TID250R32-12	25 - 25.9	32	300	60	399.3	400.8	396.2	25	DM*250 - DM*259

Tool diameter (mm)	Hole diameter tolerance (mm)*
ø8 - ø17.9	+0.05 / 0
ø18 - ø25.9	+0.055 / 0

\*Just for reference

- An overall length (OAL) differs based on each head geometry.
- When using the drill at a higher feed rate, make sure to provide an axial support by placing the overhang adjusting screw at the drill shank end in the tool holder. This will prevent high thrust force from pushing the drill back into the holder during drilling.
- For drill diameters from ø8 - ø9.9 mm, the drill shoulder to shank bottom distance when a DMC drill head is mounted is 0.3 mm shorter when compared with a DMP head of the equivalent sizes. The distances are the same for the DMC and DMP drill heads in other diameters than the above.

### SPARE PARTS



Designation	Clamping key
TID080... - TID095...	K-TID6-9.99
TID100... - TID190...	K-TID10-19.99
TID200... - TID250...	K-TID20-26.99

Reference pages: Head → **J029 - J036**  
Standard cutting conditions → **J037**

# TIDCF

## Chamfering adapter

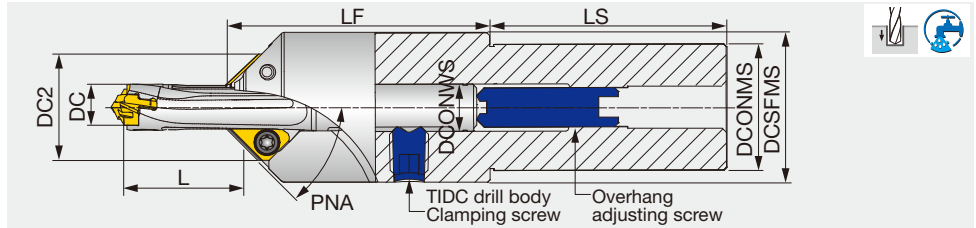

Inch	DC	DCONMS	DCSFMS	DC2	LF	LS	L* L/D = 3	L* L/D = 5	Drill body	DCONWS
TIDCF100-WU1.00-.394-.409	0.374 - 0.409	1.000	1.496	0.981	2.650	2.205	0.571 - 1.252	1.248 - 2.039	TIDC100C10-...	0.394
TIDCF110-WU1.00-.413-.449	0.413 - 0.449	1.000	1.496	1.019	2.654	2.205	0.618 - 1.311	1.228 - 2.134	TIDC105C11-..., TIDC110C11-...	0.433
TIDCF120-WU1.00-.453-.488	0.453 - 0.488	1.000	0.984	1.060	2.646	2.205	0.638 - 1.390	1.343 - 2.256	TIDC115C12-..., TIDC120C12-...	0.472
TIDCF130-WU1.00-.492-.528	0.492 - 0.528	1.000	0.984	1.098	2.646	2.205	0.594 - 1.447	1.331 - 2.339	TIDC125C13-..., TIDC130C13-...	0.512
TIDCF140-WU1.25-.531-.567	0.531 - 0.567	1.250	1.496	1.119	2.646	2.362	0.650 - 1.484	1.441 - 2.425	TIDC135C14-..., TIDC140C14-...	0.551
TIDCF150-WU1.25-.571-.626	0.571 - 0.626	1.250	1.496	1.159	2.646	2.362	0.634 - 1.559	1.563 - 2.551	TIDC145C15-..., TIDC150C15-...	0.591
TIDCF160-WU1.25-.630-.665	0.630 - 0.665	1.250	1.496	1.197	2.646	2.362	0.689 - 1.634	1.681 - 2.677	TIDC160C16-...	0.630
TIDCF170-WU1.25-.669-.705	0.669 - 0.705	1.250	1.496	1.240	2.654	2.362	0.697 - 1.689	1.630 - 2.768	TIDC170C17-...	0.669
TIDCF180-WU1.25-.709-.744	0.709 - 0.744	1.250	1.496	1.274	2.654	2.362	0.713 - 1.772	1.764 - 2.878	TIDC180C18-...	0.709
TIDCF190-WU1.25-.748-.783	0.748 - 0.783	1.250	1.496	1.313	2.653	2.362	0.756 - 1.756	1.732 - 2.909	TIDC190C19-...	0.748

L\* is the dimension when using 45° chamfering insert.  
Shank: flat cotter

Metric	DC	DCONMS	DCSFMS	DC2	LF	LS	L* L/D = 3	L* L/D = 5	Drill body	DCONWS	Insert
TIDCF080-W20	7.5 - 7.9	20	25	18.8	47.4	50	12.6 - 24	17.3 - 38	TIDC075C8-...	8	XCGT06...
TIDCF080-W20	8.0 - 8.4	20	25	18.8	47.4	50	13.5 - 24.6	24.7 - 45	TIDC080C8-...	8	XCGT06...
TIDCF090-W20	8.5 - 8.9	20	25	19.8	47.4	50	12.6 - 26.2	18.5 - 43	TIDC085C9-...	9	XCGT06...
TIDCF090-W20	9.0 - 9.4	20	25	19.8	47.4	50	13 - 29.2	22.9 - 46.8	TIDC090C9-...	9	XCGT06...
TIDCF100-W32	9.5 - 9.9	32	38	24.9	67.3	60	12.9 - 27.8	26 - 47	TIDC095C10-...	10	XHG*09...
TIDCF100-W32	10 - 10.4	32	38	24.9	67.3	60	14.5 - 31.8	31.7 - 51.8	TIDC100C10-...	10	XHG*09...
TIDCF110-W32	10.5 - 10.9	32	38	25.9	67.3	60	15.7 - 33.3	31.2 - 54.2	TIDC105C11-...	11	XHG*09...
TIDCF110-W32	11 - 11.4	32	38	25.9	67.3	60	16.2 - 35.3	34.1 - 57.3	TIDC110C11-...	11	XHG*09...
TIDCF120-W32	11.5 - 11.9	32	38	26.9	67.3	60	15.1 - 36.7	33.8 - 59.4	TIDC115C12-...	12	XHG*09...
TIDCF120-W32	12 - 12.4	32	38	26.9	67.3	60	16.5 - 37.7	36.6 - 61.6	TIDC120C12-...	12	XHG*09...
TIDCF130-W32	12.5 - 12.9	32	38	27.9	67.3	60	16.1 - 39.6	39.7 - 64.8	TIDC125C13-...	13	XHG*09...
TIDCF130-W32	13 - 13.4	32	38	27.9	67.3	60	17.5 - 41.5	42.7 - 68	TIDC130C13-...	13	XHG*09...
TIDCF140-W32	13.5 - 13.9	32	38	28.4	67.3	60	17.7 - 42.9	41.4 - 70.3	TIDC135C14-...	14	XHG*09...
TIDCF140-W32	14 - 14.4	32	38	28.4	67.3	60	18.1 - 45	44.8 - 73.1	TIDC140C14-...	14	XHG*09...
TIDCF150-W32	14.5 - 14.9	32	38	29.4	67.3	60	19.2 - 44.6	44 - 73.9	TIDC145C15-...	15	XHG*09...
TIDCF150-W32	15 - 15.9	32	38	29.4	67.3	60	19.7 - 47.4	47.6 - 80.7	TIDC150C15-...	15	XHG*09...
TIDCF160-W32	16 - 16.9	32	38	30.4	67.3	60	19.5 - 55.3	57 - 87.5	TIDC160C16-...	16	XHG*09...
TIDCF170-W32	17 - 17.9	32	38	31.4	67.3	60	21.4 - 54.9	55.9 - 88.5	TIDC170C17-...	17	XHG*09...
TIDCF180-W32	18 - 18.9	32	38	32.4	67.3	60	24.2 - 65.2	60 - 93	TIDC180C18-...	18	XHG*09...
TIDCF190-W32	19 - 19.9	32	38	33.4	75	60	28.5 - 62.3	67 - 100	TIDC190C19-...	19	XHG*09...

L\* is the dimension when using 45° chamfering insert.  
Shank: whistle notch

### SPARE PARTS

Designation	Insert screw	Grip	Clamping screw of TIDC drill body	Overhang adjusting screw	Torx bit	Wrench	Wrench
TIDCF080... - TIDCF090...	SR14-560	-	SRM6X6DIN916	SRM6X1S	-	HW3.0	T-8D
TIDCF100... - TIDCF190...	SR14-544/S	SW6-SD	SRM10X10DIN916	SRM10X1.5S	BT15S	HW5.0	-

Recommended clamping torque: SR14-544/S = 3.54 lbf-ft, 4.8 N-m

### ● How to mount the chamfering adapter on the TIDC drill body

The overhang length of the drill can be changed by the adjusting screw at the bottom of the adapter. The rear end of the drill body must be in contact with the adjusting screw as the screw supports the drill against thrust force when drilling.

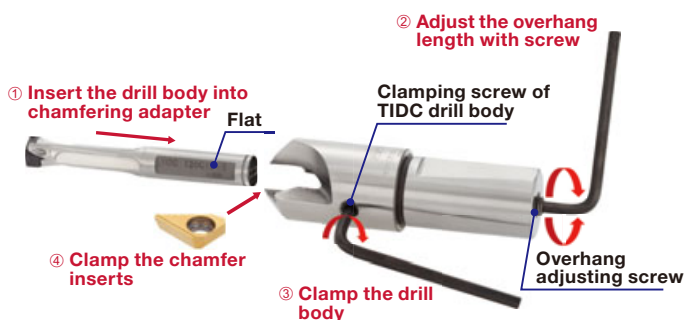

#### Procedures

- Place the TIDC drill body into the chamfering adapter without chamfer inserts.
- Adjust the overhang length of the drill body with the adjusting screw at the bottom of the adapter.
- Adjust the position of the drill body so that the drill body is fixed at the flat and tighten the clamping screw of the drill body. This aligns the flutes of the TIDC drill body with the chamfer inserts.
- To clamp the chamfer inserts, tighten the clamping screw of the insert while pushing the insert into the insert pocket.

Notice: Before removing the drill body from the adapter, chamfer inserts must be unclamped. The overhang adjusting screw can be handled from the top of the adapter with a flat-blade screwdriver. The overhang length of the drill body can be adjusted after the adapter is positioned on the drill shank.





## CHAMFERING INSERT

XCGT-30DT/XHGT-30A

XCGT-45DT/XHGR-45A

XCGT-60DT/XHGR-60A

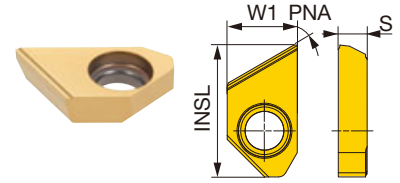
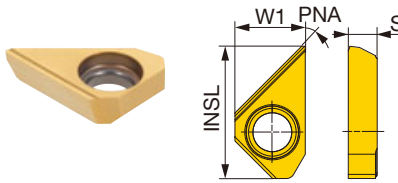
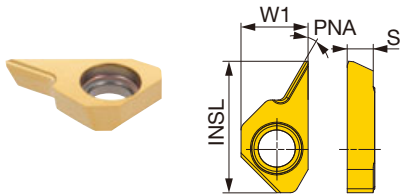

<b>P</b> Steel	★									
<b>M</b> Stainless	★									
<b>K</b> Cast iron	★									
<b>N</b> Non-ferrous	☆									
<b>S</b> Superalloys	★									
<b>H</b> Hard materials	★									

★ : First choice  
 ☆ : Second choice

Designation	Chamfering angle PNA	Maximum width of chamfer*	Coated								W1 (mm)	INSL (mm)	S (mm)	
			GH730											
XCGT060300-30DT	30°	2	●									6.18	12.3	2.8
XCGT060300-45DT	45°	4	●									6.18	12.3	2.8
XCGT060300-60DT	60°	4	●									6.18	12.3	2.8
XHGT090300-30A	30°	3	●									8.5	16	3.3
XHGR090300-45A	45°	6	●									8.5	16	3.3
XHGR090300-60A	60°	6	●									8.5	16	3.3

\*Please reduce the feed rate to half when chamfering over 60% of maximum width of chamfer.

● : Line up  
 2 pieces per package

## INSERT FOR SPECIAL CHAMFERING ADAPTERS

AOMT...

AOMT06-C45

AOMT03-N-\*\*DT

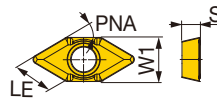
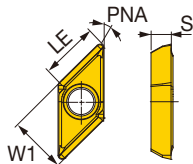

<b>P</b> Steel	★									
<b>M</b> Stainless	★									
<b>K</b> Cast iron	★									
<b>N</b> Non-ferrous	☆									
<b>S</b> Superalloys	★									
<b>H</b> Hard materials	★									

★ : First choice  
 ☆ : Second choice

Designation	LE (in)	Chamfering angle PNA	Coated								W1 (in)	S (in)	
			GH730										
AOMT060204-C45	0.177	45°	●									0.223	0.077
AOMT030204-N-30DT	0.157	30°	●									0.157	0.063
AOMT030204-N-45DT	0.157	45°	●									0.110	0.063

● : Line up



# DRILL HEAD

## DMP (General purpose)

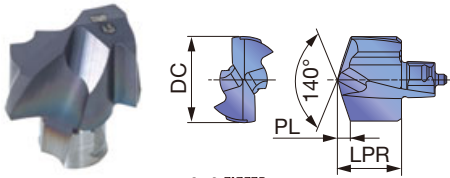

**ADDMORILL**  
DMP040 - DMP059

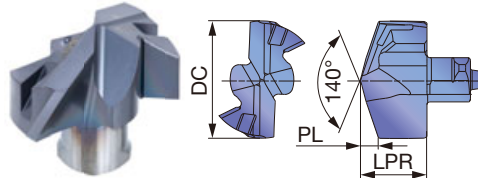

**DRILLMEISTER**  
DMP060 - DMP259

Tool diameter (in)	Head diameter tolerance (in)
ø0.157" - ø0.705"	+0.0007" / 0
ø0.709" - ø1.020"	+0.0008" / 0
Tool diameter (mm)	Head diameter tolerance (mm)
ø4 - ø17.9	+0.018 / 0
ø18 - ø25.9	+0.021 / 0

P	Steel	☆	★
M	Stainless	☆	★
K	Cast iron	☆	★
N	Non-ferrous	☆	★
S	Superalloys	☆	★
H	Hard materials	☆	★

P	Steel	☆	★
M	Stainless	☆	★
K	Cast iron	☆	★
N	Non-ferrous	☆	★
S	Superalloys	☆	★
H	Hard materials	☆	★

★ : First choice  
☆ : Second choice

Designation	DC (in)	DC (mm)	LPR (mm)	Coated		PL (mm)	Body
				AH725	AH9130		
DMP040	0.157	4	3.1	●		0.62	TID*040...
DMP041	0.161	4.1	3.1	●		0.64	TID*040...
DMP042	0.165	4.2	3.1	●		0.66	TID*040...
DMP043	0.169	4.3	3.1	●		0.67	TID*040...
DMP044	0.173	4.4	3.1	●		0.69	TID*040...
DMP045	0.177	4.5	3.55	●		0.66	TID*045...
DMP046	0.181	4.6	3.55	●		0.68	TID*045...
DMP047	0.185	4.7	3.55	●		0.70	TID*045...
DMP048	0.189	4.8	3.55	●		0.71	TID*045...
DMP049	0.193	4.9	3.55	●		0.73	TID*045...
DMP050	0.197	5	3.7	●		0.73	TID*050...
DMP051	0.201	5.1	3.7	●		0.75	TID*050...
DMP052	0.205	5.2	3.7	●		0.77	TID*050...
DMP053	0.209	5.3	3.7	●		0.78	TID*050...
DMP054	0.213	5.4	3.7	●		0.8	TID*050...
DMP055	0.217	5.5	3.85	●		0.81	TID*055...
DMP056	0.220	5.6	3.85	●		0.83	TID*055...
DMP057	0.224	5.7	3.85	●		0.85	TID*055...
DMP058	0.228	5.8	3.85	●		0.86	TID*055...
DMP059	0.232	5.9	3.85	●		0.88	TID*055...
DMP060	0.236	6	3.85	●	●	1.09	TID*060...
DMP061	0.240	6.1	3.85	●	●	1.11	TID*060...
DMP062	0.244	6.2	3.85	●	●	1.13	TID*060...
DMP063	0.248	6.3	3.85	●	●	1.14	TID*060...
DMP064	0.252	6.4	3.85	●	●	1.16	TID*060...
DMP065	0.256	6.5	4.15	●	●	1.27	TID*065...
DMP066	0.260	6.6	4.15	●	●	1.29	TID*065...
DMP067	0.264	6.7	4.15	●	●	1.31	TID*065...
DMP068	0.268	6.8	4.15	●	●	1.33	TID*065...
DMP069	0.272	6.9	4.15	●	●	1.34	TID*065...
DMP070	0.276	7	4.45	●	●	1.03	TID*070...
DMP071	0.280	7.1	4.45	●	●	1.05	TID*070...
DMP072	0.283	7.2	4.45	●	●	1.07	TID*070...
DMP073	0.287	7.3	4.45	●	●	1.08	TID*070...
DMP074	0.291	7.4	4.45	●	●	1.1	TID*070...
DMP075	0.295	7.5	4.45	●	●	1.12	TID*075...
DMP076	0.299	7.6	4.45	●	●	1.14	TID*075...
DMP077	0.303	7.7	4.45	●	●	1.16	TID*075...
DMP078	0.307	7.8	4.45	●	●	1.18	TID*075...
DMP079	0.311	7.9	4.45	●	●	1.19	TID*075...
DMP080	0.315	8	5.25	●	●	1.2	TID*080...
DMP081	0.319	8.1	5.25	●	●	1.22	TID*080...
DMP082	0.323	8.2	5.25	●	●	1.24	TID*080...

Designation	DC (in)	DC (mm)	LPR (mm)	Coated		PL (mm)	Body
				AH725	AH9130		
DMP083	0.327	8.3	5.25	●	●	1.25	TID*080...
DMP084	0.331	8.4	5.25	●	●	1.27	TID*080...
DMP085	0.335	8.5	5.25	●	●	1.29	TID*085...
DMP086	0.339	8.6	5.25	●	●	1.31	TID*085...
DMP087	0.343	8.7	5.25	●	●	1.33	TID*085...
DMP088	0.346	8.8	5.25	●	●	1.35	TID*085...
DMP089	0.350	8.9	5.25	●	●	1.36	TID*085...
DMP090	0.354	9	5.65	●	●	1.37	TID*090...
DMP091	0.358	9.1	5.65	●	●	1.39	TID*090...
DMP092	0.362	9.2	5.65	●	●	1.41	TID*090...
DMP093	0.366	9.3	5.65	●	●	1.42	TID*090...
DMP094	0.370	9.4	5.65	●	●	1.44	TID*090...
DMP095	0.374	9.5	5.65	●	●	1.46	TID*095...
DMP096	0.378	9.6	5.65	●	●	1.48	TID*095...
DMP097	0.382	9.7	5.65	●	●	1.5	TID*095...
DMP098	0.386	9.8	5.65	●	●	1.52	TID*095...
DMP099	0.390	9.9	5.65	●	●	1.53	TID*095...
DMP100	0.394	10	6.05	●	●	1.47	TID*100...
DMP101	0.398	10.1	6.05	●	●	1.49	TID*100...
DMP102	0.402	10.2	6.05	●	●	1.51	TID*100...
DMP103	0.406	10.3	6.05	●	●	1.52	TID*100...
DMP104	0.409	10.4	6.05	●	●	1.54	TID*100...
DMP105	0.413	10.5	6.05	●	●	1.56	TID*105...
DMP106	0.417	10.6	6.05	●	●	1.58	TID*105...
DMP107	0.421	10.7	6.05	●	●	1.6	TID*105...
DMP108	0.425	10.8	6.05	●	●	1.62	TID*105...
DMP109	0.429	10.9	6.05	●	●	1.63	TID*105...
DMP110	0.433	11	6.45	●	●	1.67	TID*110...
DMP111	0.437	11.1	6.45	●	●	1.69	TID*110...
DMP112	0.441	11.2	6.45	●	●	1.71	TID*110...
DMP113	0.445	11.3	6.45	●	●	1.72	TID*110...
DMP114	0.449	11.4	6.45	●	●	1.74	TID*110...
DMP115	0.453	11.5	6.45	●	●	1.76	TID*115...
DMP116	0.457	11.6	6.45	●	●	1.78	TID*115...
DMP117	0.461	11.7	6.45	●	●	1.8	TID*115...
DMP118	0.465	11.8	6.45	●	●	1.82	TID*115...
DMP119	0.469	11.9	6.45	●	●	1.83	TID*115...
DMP120	0.472	12	6.8	●	●	1.82	TID*120...
DMP121	0.476	12.1	6.8	●	●	1.84	TID*120...
DMP122	0.480	12.2	6.8	●	●	1.86	TID*120...
DMP123	0.484	12.3	6.8	●	●	1.87	TID*120...
DMP124	0.488	12.4	6.8	●	●	1.89	TID*120...
DMP125	0.492	12.5	6.8	●	●	1.91	TID*125...

Package Quantity: 0.157" - 0.783" = 2 pcs.  
0.787" - 1.020" = 1 pc.

● : Line up



## DMP (General purpose)

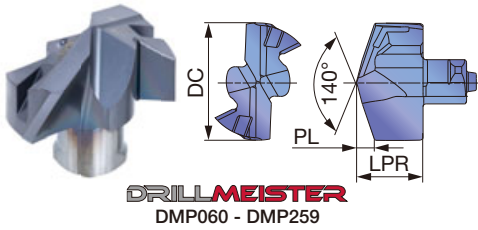

Tool diameter (in)	Head diameter tolerance (in)
ø0.157" - ø0.705"	+0.0007" / 0
ø0.709" - ø1.020"	+0.0008" / 0
Tool diameter (mm)	Head diameter tolerance (mm)
ø4 - ø17.9	+0.018 / 0
ø18 - ø25.9	+0.021 / 0

Material	Star Rating	Choice
P Steel	☆	★
M Stainless	☆	★
K Cast iron	☆	★
N Non-ferrous	☆	★
S Superalloys	☆	★
H Hard materials	☆	★

Material	Star Rating	Choice
P Steel	☆	★
M Stainless	☆	★
K Cast iron	☆	★
N Non-ferrous	☆	★
S Superalloys	☆	★
H Hard materials	☆	★

★ : First choice  
☆ : Second choice

Designation	DC (in)	DC (mm)	LPR (mm)	Coated		PL (mm)	Body
				AH725	AH9130		
DMP126	0.496	12.6	6.8	●	●	1.93	TID*125...
DMP127	0.500	12.7	6.8	●	●	1.95	TID*125...
DMP128	0.504	12.8	6.8	●	●	1.97	TID*125...
DMP129	0.508	12.9	6.8	●	●	1.98	TID*125...
DMP130	0.512	13	7.4	●	●	1.96	TID*130...
DMP131	0.516	13.1	7.4	●	●	1.98	TID*130...
DMP132	0.520	13.2	7.4	●	●	2	TID*130...
DMP133	0.524	13.3	7.4	●	●	2.01	TID*130...
DMP134	0.528	13.4	7.4	●	●	2.03	TID*130...
DMP135	0.531	13.5	7.4	●	●	2.05	TID*135...
DMP136	0.535	13.6	7.4	●	●	2.07	TID*135...
DMP137	0.539	13.7	7.4	●	●	2.09	TID*135...
DMP138	0.543	13.8	7.4	●	●	2.11	TID*135...
DMP139	0.547	13.9	7.4	●	●	2.12	TID*135...
DMP140	0.551	14	7.95	●	●	2.12	TID*140...
DMP141	0.555	14.1	7.95	●	●	2.14	TID*140...
DMP142	0.559	14.2	7.95	●	●	2.16	TID*140...
DMP143	0.563	14.3	7.95	●	●	2.17	TID*140...
DMP144	0.567	14.4	7.95	●	●	2.19	TID*140...
DMP145	0.571	14.5	7.95	●	●	2.21	TID*145...
DMP146	0.575	14.6	7.95	●	●	2.23	TID*145...
DMP147	0.579	14.7	7.95	●	●	2.25	TID*145...
DMP148	0.583	14.8	7.95	●	●	2.27	TID*145...
DMP149	0.587	14.9	7.95	●	●	2.28	TID*145...
DMP150	0.591	15	8.53	●	●	2.27	TID*150...
DMP151	0.594	15.1	8.53	●	●	2.29	TID*150...
DMP152	0.598	15.2	8.53	●	●	2.31	TID*150...
DMP153	0.602	15.3	8.53	●	●	2.32	TID*150...
DMP154	0.606	15.4	8.53	●	●	2.34	TID*150...
DMP155	0.610	15.5	8.53	●	●	2.36	TID*150...
DMP156	0.614	15.6	8.53	●	●	2.38	TID*150...
DMP157	0.618	15.7	8.53	●	●	2.4	TID*150...
DMP158	0.622	15.8	8.53	●	●	2.42	TID*150...
DMP159	0.626	15.9	8.53	●	●	2.43	TID*150...
DMP160	0.630	16	9.1	●	●	2.42	TID*160...
DMP161	0.634	16.1	9.1	●	●	2.44	TID*160...
DMP162	0.638	16.2	9.1	●	●	2.46	TID*160...
DMP163	0.642	16.3	9.1	●	●	2.47	TID*160...
DMP164	0.646	16.4	9.1	●	●	2.49	TID*160...
DMP165	0.650	16.5	9.1	●	●	2.51	TID*160...
DMP166	0.654	16.6	9.1	●	●	2.53	TID*160...
DMP167	0.657	16.7	9.1	●	●	2.55	TID*160...
DMP168	0.661	16.8	9.1	●	●	2.57	TID*160...

Designation	DC (in)	DC (mm)	LPR (mm)	Coated		PL (mm)	Body
				AH725	AH9130		
DMP169	0.665	16.9	9.1	●	●	2.58	TID*160...
DMP170	0.669	17	9.7	●	●	2.59	TID*170...
DMP171	0.673	17.1	9.7	●	●	2.61	TID*170...
DMP172	0.677	17.2	9.7	●	●	2.63	TID*170...
DMP173	0.681	17.3	9.7	●	●	2.64	TID*170...
DMP174	0.685	17.4	9.7	●	●	2.66	TID*170...
DMP175	0.689	17.5	9.7	●	●	2.68	TID*170...
DMP176	0.693	17.6	9.7	●	●	2.7	TID*170...
DMP177	0.697	17.7	9.7	●	●	2.72	TID*170...
DMP178	0.701	17.8	9.7	●	●	2.74	TID*170...
DMP179	0.705	17.9	9.7	●	●	2.75	TID*170...
DMP180	0.709	18	10.3	●	●	2.73	TID*180...
DMP181	0.713	18.1	10.3	●	●	2.75	TID*180...
DMP182	0.717	18.2	10.3	●	●	2.77	TID*180...
DMP183	0.720	18.3	10.3	●	●	2.78	TID*180...
DMP184	0.724	18.4	10.3	●	●	2.8	TID*180...
DMP185	0.728	18.5	10.3	●	●	2.82	TID*180...
DMP186	0.732	18.6	10.3	●	●	2.84	TID*180...
DMP187	0.736	18.7	10.3	●	●	2.86	TID*180...
DMP188	0.740	18.8	10.3	●	●	2.88	TID*180...
DMP189	0.744	18.9	10.3	●	●	2.89	TID*180...
DMP190	0.748	19	10.8	●	●	2.88	TID*190...
DMP1905	0.750	19.05	10.8	●	●	2.89	TID*190...
DMP191	0.752	19.1	10.8	●	●	2.9	TID*190...
DMP192	0.756	19.2	10.8	●	●	2.92	TID*190...
DMP1927	0.759	19.27	10.8	●	●	2.93	TID*190...
DMP193	0.760	19.3	10.8	●	●	2.93	TID*190...
DMP194	0.764	19.4	10.8	●	●	2.95	TID*190...
DMP195	0.768	19.5	10.8	●	●	2.97	TID*190...
DMP196	0.772	19.6	10.8	●	●	2.99	TID*190...
DMP197	0.776	19.7	10.8	●	●	3.01	TID*190...
DMP198	0.780	19.8	10.8	●	●	3.03	TID*190...
DMP199	0.783	19.9	10.8	●	●	3.04	TID*190...
DMP200	0.787	20	11.4	●	●	3.02	TID*200...
DMP201	0.791	20.1	11.4	●	●	3.04	TID*200...
DMP202	0.795	20.2	11.4	●	●	3.06	TID*200...
DMP203	0.799	20.3	11.4	●	●	3.07	TID*200...
DMP204	0.803	20.4	11.4	●	●	3.09	TID*200...
DMP205	0.807	20.5	11.4	●	●	3.11	TID*200...
DMP206	0.811	20.6	11.4	●	●	3.13	TID*200...
DMP207	0.815	20.7	11.4	●	●	3.15	TID*200...
DMP208	0.819	20.8	11.4	●	●	3.17	TID*200...
DMP209	0.823	20.9	11.4	●	●	3.18	TID*200...

Package Quantity: 0.157" - 0.783" = 2 pcs.  
0.787" - 1.020" = 1 pc.

● : Line up

<b>P</b>	Steel	☆	★	
<b>M</b>	Stainless	☆	★	
<b>K</b>	Cast iron	☆	★	
<b>N</b>	Non-ferrous			
<b>S</b>	Superalloys	☆	★	★ : First choice
<b>H</b>	Hard materials	☆	★	☆ : Second choice

Designation	DC (in)	DC (mm)	LPR (mm)	Coated		PL (mm)	Body
				AH725	AH9130		
DMP210	0.827	21	11.98	●	●	3.18	TID*210...
DMP211	0.831	21.1	11.98	●	●	3.2	TID*210...
DMP212	0.835	21.2	11.98	●	●	3.22	TID*210...
DMP213	0.839	21.3	11.98	●	●	3.23	TID*210...
DMP214	0.843	21.4	11.98	●	●	3.25	TID*210...
DMP215	0.846	21.5	11.98	●	●	3.27	TID*210...
DMP216	0.850	21.6	11.98	●	●	3.29	TID*210...
DMP217	0.854	21.7	11.98	●	●	3.31	TID*210...
DMP218	0.858	21.8	11.98	●	●	3.33	TID*210...
DMP219	0.862	21.9	11.98	●	●	3.34	TID*210...
DMP220	0.866	22	12.56	●	●	3.32	TID*220...
DMP221	0.870	22.1	12.56	●	●	3.34	TID*220...
DMP222	0.874	22.2	12.56	●	●	3.36	TID*220...
DMP223	0.878	22.3	12.56	●	●	3.37	TID*220...
DMP224	0.882	22.4	12.56	●	●	3.39	TID*220...
DMP225	0.886	22.5	12.56	●	●	3.41	TID*220...
DMP226	0.890	22.6	12.56	●	●	3.43	TID*220...
DMP227	0.894	22.7	12.56	●	●	3.45	TID*220...
DMP228	0.898	22.8	12.56	●	●	3.47	TID*220...
DMP229	0.902	22.9	12.56	●	●	3.48	TID*220...
DMP230	0.906	23	13.13	●	●	3.46	TID*230...
DMP231	0.909	23.1	13.13	●	●	3.48	TID*230...
DMP232	0.913	23.2	13.13	●	●	3.5	TID*230...
DMP233	0.917	23.3	13.13	●	●	3.51	TID*230...
DMP234	0.921	23.4	13.13	●	●	3.53	TID*230...
DMP235	0.925	23.5	13.13	●	●	3.55	TID*230...
DMP236	0.929	23.6	13.13	●	●	3.57	TID*230...
DMP237	0.933	23.7	13.13	●	●	3.59	TID*230...
DMP238	0.937	23.8	13.13	●	●	3.61	TID*230...
DMP239	0.941	23.9	13.13	●	●	3.62	TID*230...
DMP240	0.945	24	13.7	●	●	3.62	TID*240...
DMP241	0.949	24.1	13.7	●	●	3.64	TID*240...
DMP242	0.953	24.2	13.7	●	●	3.66	TID*240...
DMP243	0.957	24.3	13.7	●	●	3.67	TID*240...
DMP244	0.961	24.4	13.7	●	●	3.69	TID*240...
DMP245	0.965	24.5	13.7	●	●	3.71	TID*240...
DMP246	0.969	24.6	13.7	●	●	3.73	TID*240...
DMP247	0.972	24.7	13.7	●	●	3.75	TID*240...
DMP248	0.976	24.8	13.7	●	●	3.77	TID*240...
DMP249	0.980	24.9	13.7	●	●	3.78	TID*240...
DMP250	0.984	25	14.3	●	●	3.8	TID*250...
DMP251	0.988	25.1	14.3	●	●	3.82	TID*250...
DMP252	0.992	25.2	14.3	●	●	3.84	TID*250...
DMP253	0.996	25.3	14.3	●	●	3.85	TID*250...
DMP254	1.000	25.4	14.3	●	●	3.87	TID*250...
DMP255	1.004	25.5	14.3	●	●	3.89	TID*250...
DMP256	1.008	25.6	14.3	●	●	3.91	TID*250...
DMP2567	1.011	25.67	14.3	●	●	3.92	TID*250...
DMP257	1.012	25.7	14.3	●	●	3.93	TID*250...
DMP258	1.016	25.8	14.3	●	●	3.95	TID*250...
DMP259	1.020	25.9	14.3	●	●	3.96	TID*250...

Package Quantity: 0.157" - 0.783" = 2 pcs.      ● : Line up  
0.787" - 1.020" = 1 pc.

Grade  
Insert  
Ext. Toolholder  
Int. Toolholder  
Threading  
Grooving  
Miniature tool  
Milling cutter  
Endmill  
Drilling tool  
Tooling System  
User's Guide  
Index



## DMC (High precision hole making)

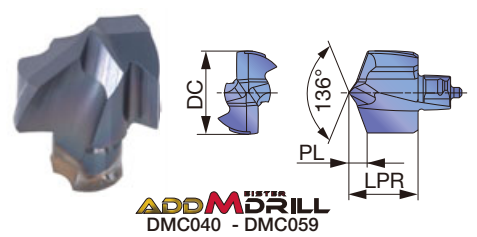

**ADDM DRILL**  
DMC040 - DMC059

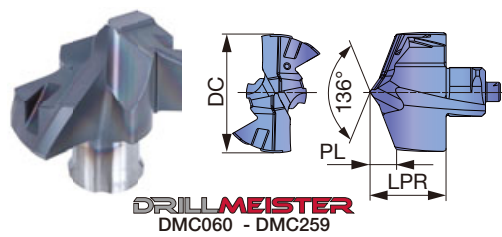

**DRILLMEISTER**  
DMC060 - DMC259

<b>Tool diameter (in)</b>	<b>Head diameter tolerance (in)</b>
ø0.157" - ø0.705"	+0.0007" / 0
ø0.709" - ø1.020"	+0.0008" / 0
<b>Tool diameter (mm)</b>	<b>Head diameter tolerance (mm)</b>
ø4 - ø17.9	+0.018 / 0
ø18 - ø25.9	+0.021 / 0

<b>P</b>	Steel	★		
<b>M</b>	Stainless	★		
<b>K</b>	Cast iron	★		
<b>N</b>	Non-ferrous	☆		
<b>S</b>	Superalloys	★		
<b>H</b>	Hard materials	★		

<b>P</b>	Steel	★		
<b>M</b>	Stainless	★		
<b>K</b>	Cast iron	★		
<b>N</b>	Non-ferrous	☆		
<b>S</b>	Superalloys	★		
<b>H</b>	Hard materials	★		

★ : First choice  
☆ : Second choice

Designation	DC (in)	DC (mm)	LPR (mm)	Coated		PL (mm)	Body
				AH9130			
DMC040	0.157	4	3.51	●		0.86	TID*040...
DMC041	0.161	4.1	3.51	●		0.88	TID*040...
DMC042	0.165	4.2	3.51	●		0.9	TID*040...
DMC043	0.169	4.3	3.51	●		0.92	TID*040...
DMC044	0.173	4.4	3.51	●		0.94	TID*040...
DMC045	0.177	4.5	3.81	●		0.97	TID*045...
DMC046	0.181	4.6	3.81	●		0.99	TID*045...
DMC047	0.185	4.7	3.81	●		1.01	TID*045...
DMC048	0.189	4.8	3.81	●		1.03	TID*045...
DMC049	0.193	4.9	3.81	●		1.05	TID*045...
DMC050	0.197	5	4.14	●		1.09	TID*050...
DMC051	0.201	5.1	4.14	●		1.11	TID*050...
DMC052	0.205	5.2	4.14	●		1.13	TID*050...
DMC053	0.209	5.3	4.14	●		1.15	TID*050...
DMC054	0.213	5.4	4.14	●		1.17	TID*050...
DMC055	0.217	5.5	4.17	●		1.22	TID*055...
DMC056	0.220	5.6	4.17	●		1.24	TID*055...
DMC057	0.224	5.7	4.17	●		1.26	TID*055...
DMC058	0.228	5.8	4.17	●		1.28	TID*055...
DMC059	0.232	5.9	4.17	●		1.3	TID*055...
DMC060	0.236	6	4	●		1.24	TID*060...
DMC061	0.240	6.1	4	●		1.26	TID*060...
DMC062	0.244	6.2	4	●		1.28	TID*060...
DMC063	0.248	6.3	4	●		1.3	TID*060...
DMC064	0.252	6.4	4	●		1.32	TID*060...
DMC065	0.256	6.5	4.3	●		1.33	TID*065...
DMC066	0.260	6.6	4.3	●		1.35	TID*065...
DMC067	0.264	6.7	4.3	●		1.37	TID*065...
DMC068	0.268	6.8	4.3	●		1.39	TID*065...
DMC069	0.272	6.9	4.3	●		1.41	TID*065...
DMC070	0.276	7	4.9	●		1.48	TID*070...
DMC071	0.280	7.1	4.9	●		1.5	TID*070...
DMC072	0.283	7.2	4.9	●		1.52	TID*070...
DMC073	0.287	7.3	4.9	●		1.54	TID*070...
DMC074	0.291	7.4	4.9	●		1.56	TID*070...
DMC075	0.295	7.5	4.9	●		1.58	TID*075...
DMC076	0.299	7.6	4.9	●		1.6	TID*075...
DMC077	0.303	7.7	4.9	●		1.62	TID*075...
DMC078	0.307	7.8	4.9	●		1.64	TID*075...
DMC079	0.311	7.9	4.9	●		1.66	TID*075...
DMC080	0.315	8	5.4	●		1.62	TID*080...
DMC081	0.319	8.1	5.4	●		1.64	TID*080...
DMC082	0.323	8.2	5.4	●		1.66	TID*080...
DMC083	0.327	8.3	5.4	●		1.68	TID*080...
DMC084	0.331	8.4	5.4	●		1.7	TID*080...
DMC085	0.335	8.5	5.4	●		1.72	TID*085...
DMC086	0.339	8.6	5.4	●		1.74	TID*085...
DMC087	0.343	8.7	5.4	●		1.76	TID*085...
DMC088	0.346	8.8	5.4	●		1.78	TID*085...
DMC089	0.350	8.9	5.4	●		1.8	TID*085...

Designation	DC (in)	DC (mm)	LPR (mm)	Coated		PL (mm)	Body
				AH9130			
DMC090	0.354	9	5.8	●		1.91	TID*090...
DMC091	0.358	9.1	5.8	●		1.93	TID*090...
DMC092	0.362	9.2	5.8	●		1.95	TID*090...
DMC093	0.366	9.3	5.8	●		1.97	TID*090...
DMC094	0.370	9.4	5.8	●		1.99	TID*090...
DMC095	0.374	9.5	5.8	●		2.01	TID*095...
DMC096	0.378	9.6	5.8	●		2.03	TID*095...
DMC097	0.382	9.7	5.8	●		2.05	TID*095...
DMC098	0.386	9.8	5.8	●		2.07	TID*095...
DMC099	0.390	9.9	5.8	●		2.09	TID*095...
DMC100	0.394	10	6.67	●		2.09	TID*100...
DMC101	0.398	10.1	6.67	●		2.11	TID*100...
DMC102	0.402	10.2	6.67	●		2.13	TID*100...
DMC103	0.406	10.3	6.67	●		2.15	TID*100...
DMC104	0.409	10.4	6.67	●		2.17	TID*100...
DMC105	0.413	10.5	6.67	●		2.19	TID*105...
DMC106	0.417	10.6	6.67	●		2.21	TID*105...
DMC107	0.421	10.7	6.67	●		2.23	TID*105...
DMC108	0.425	10.8	6.67	●		2.25	TID*105...
DMC109	0.429	10.9	6.67	●		2.27	TID*105...
DMC110	0.433	11	7.1	●		2.32	TID*110...
DMC111	0.437	11.1	7.1	●		2.34	TID*110...
DMC112	0.441	11.2	7.1	●		2.36	TID*110...
DMC113	0.445	11.3	7.1	●		2.38	TID*110...
DMC114	0.449	11.4	7.1	●		2.4	TID*110...
DMC115	0.453	11.5	7.1	●		2.42	TID*115...
DMC116	0.457	11.6	7.1	●		2.44	TID*115...
DMC117	0.461	11.7	7.1	●		2.46	TID*115...
DMC118	0.465	11.8	7.1	●		2.48	TID*115...
DMC119	0.469	11.9	7.1	●		2.5	TID*115...
DMC120	0.472	12	7.43	●		2.45	TID*120...
DMC121	0.476	12.1	7.43	●		2.47	TID*120...
DMC122	0.480	12.2	7.43	●		2.49	TID*120...
DMC123	0.484	12.3	7.43	●		2.51	TID*120...
DMC124	0.488	12.4	7.43	●		2.53	TID*120...
DMC125	0.492	12.5	7.43	●		2.55	TID*125...
DMC126	0.496	12.6	7.43	●		2.57	TID*125...
DMC127	0.500	12.7	7.43	●		2.59	TID*125...
DMC128	0.504	12.8	7.43	●		2.61	TID*125...
DMC129	0.508	12.9	7.43	●		2.63	TID*125...
DMC130	0.512	13	8.15	●		2.71	TID*130...
DMC131	0.516	13.1	8.15	●		2.73	TID*130...
DMC132	0.520	13.2	8.15	●		2.75	TID*130...
DMC133	0.524	13.3	8.15	●		2.77	TID*130...
DMC134	0.528	13.4	8.15	●		2.79	TID*130...
DMC135	0.531	13.5	8.15	●		2.81	TID*135...
DMC136	0.535	13.6	8.15	●		2.83	TID*135...
DMC137	0.539	13.7	8.15	●		2.85	TID*135...

ø0.157" - ø0.783" = 2 pieces per package  
ø0.787" - ø1.020" = 1 piece per package

● : Line up







# DMH (High strength cutting edge)

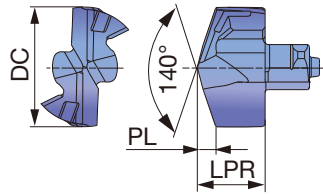

Tool diameter (in)	Head diameter tolerance (in)
ø0.236" - ø0.705"	+0.0007" / -0.0002"
ø0.709" - ø1.004"	+0.0008" / -0.0002"
Tool diameter (mm)	Head diameter tolerance (mm)
ø6 - ø17.9	+0.018 / -0.005
ø18 - ø25.5	+0.021 / -0.005

P	Steel	★		
M	Stainless	★		
K	Cast iron	★		
N	Non-ferrous			
S	Superalloys	★		
H	Hard materials	★		

P	Steel	★		
M	Stainless	★		
K	Cast iron	★		
N	Non-ferrous			
S	Superalloys	★		
H	Hard materials	★		

★ : First choice

Designation	DC (in)	DC (mm)	LPR (mm)	Coated		PL (mm)	Body
				AH9130			
DMH060	0.236	6	3.85	●		1.09	TID*060...
DMH068	0.268	6.8	4.15	●		1.33	TID*065...
DMH070	0.276	7	4.45	●		1.03	TID*070...
DMH075	0.295	7.5	4.45	●		1.12	TID*075...
DMH080	0.315	8	5.25	●		1.2	TID*080...
DMH085	0.335	8.5	5.25	●		1.29	TID*085...
DMH086	0.339	8.6	5.25	●		1.31	TID*085...
DMH087	0.343	8.7	5.25	●		1.33	TID*085...
DMH088	0.346	8.8	5.25	●		1.35	TID*085...
DMH090	0.354	9	5.65	●		1.37	TID*090...
DMH095	0.374	9.5	5.65	●		1.46	TID*095...
DMH097	0.382	9.7	5.65	●		1.5	TID*095...
DMH100	0.394	10	6.05	●		1.47	TID*100...
DMH101	0.398	10.1	6.05	●		1.49	TID*100...
DMH103	0.406	10.3	6.05	●		1.52	TID*100...
DMH104	0.409	10.4	6.05	●		1.54	TID*100...
DMH105	0.413	10.5	6.05	●		1.56	TID*105...
DMH106	0.417	10.6	6.05	●		1.58	TID*105...
DMH107	0.421	10.7	6.05	●		1.6	TID*105...
DMH108	0.425	10.8	6.05	●		1.62	TID*105...
DMH110	0.433	11	6.45	●		1.67	TID*110...
DMH111	0.437	11.1	6.45	●		1.69	TID*110...
DMH112	0.441	11.2	6.45	●		1.71	TID*110...
DMH113	0.445	11.3	6.45	●		1.72	TID*110...
DMH114	0.449	11.4	6.45	●		1.74	TID*110...
DMH115	0.453	11.5	6.45	●		1.76	TID*115...
DMH117	0.461	11.7	6.45	●		1.8	TID*115...
DMH118	0.465	11.8	6.45	●		1.82	TID*115...
DMH119	0.469	11.9	6.45	●		1.83	TID*115...
DMH120	0.472	12	6.8	●		1.82	TID*120...
DMH121	0.476	12.1	6.8	●		1.84	TID*120...
DMH122	0.480	12.2	6.8	●		1.86	TID*120...
DMH123	0.484	12.3	6.8	●		1.87	TID*120...
DMH124	0.488	12.4	6.8	●		1.89	TID*120...
DMH125	0.492	12.5	6.8	●		1.91	TID*125...
DMH126	0.496	12.6	6.8	●		1.93	TID*125...
DMH127	0.500	12.7	6.8	●		1.95	TID*125...
DMH128	0.504	12.8	6.8	●		1.97	TID*125...
DMH129	0.508	12.9	6.8	●		1.98	TID*125...
DMH130	0.512	13	7.4	●		1.96	TID*130...
DMH131	0.516	13.1	7.4	●		1.98	TID*130...
DMH132	0.520	13.2	7.4	●		2	TID*130...
DMH133	0.524	13.3	7.4	●		2.01	TID*130...
DMH134	0.528	13.4	7.4	●		2.03	TID*130...
DMH135	0.531	13.5	7.4	●		2.05	TID*135...
DMH136	0.535	13.6	7.4	●		2.07	TID*135...
DMH137	0.539	13.7	7.4	●		2.09	TID*135...
DMH138	0.543	13.8	7.4	●		2.11	TID*135...
DMH139	0.547	13.9	7.4	●		2.12	TID*135...
DMH140	0.551	14	7.95	●		2.12	TID*140...
DMH141	0.555	14.1	7.95	●		2.14	TID*140...
DMH142	0.559	14.2	7.95	●		2.16	TID*140...
DMH143	0.563	14.3	7.95	●		2.17	TID*140...

Designation	DC (in)	DC (mm)	LPR (mm)	Coated		PL (mm)	Body
				AH9130			
DMH144	0.567	14.4	7.95	●		2.19	TID*140...
DMH145	0.571	14.5	7.95	●		2.21	TID*145...
DMH146	0.575	14.6	7.95	●		2.23	TID*145...
DMH147	0.579	14.7	7.95	●		2.25	TID*145...
DMH150	0.591	15	8.53	●		2.27	TID*150...
DMH151	0.594	15.1	8.53	●		2.29	TID*150...
DMH152	0.598	15.2	8.53	●		2.31	TID*150...
DMH153	0.602	15.3	8.53	●		2.32	TID*150...
DMH154	0.606	15.4	8.53	●		2.34	TID*150...
DMH155	0.610	15.5	8.53	●		2.36	TID*150...
DMH156	0.614	15.6	8.53	●		2.38	TID*150...
DMH157	0.618	15.7	8.53	●		2.40	TID*150...
DMH158	0.622	15.8	8.53	●		2.42	TID*150...
DMH160	0.630	16	9.1	●		2.42	TID*160...
DMH162	0.638	16.2	9.1	●		2.46	TID*160...
DMH163	0.642	16.3	9.1	●		2.47	TID*160...
DMH165	0.650	16.5	9.1	●		2.51	TID*160...
DMH166	0.654	16.6	9.1	●		2.53	TID*160...
DMH167	0.657	16.7	9.1	●		2.55	TID*160...
DMH170	0.669	17	9.7	●		2.59	TID*170...
DMH171	0.673	17.1	9.7	●		2.61	TID*170...
DMH175	0.689	17.5	9.7	●		2.68	TID*170...
DMH177	0.697	17.7	9.7	●		2.72	TID*170...
DMH178	0.701	17.8	9.7	●		2.74	TID*170...
DMH179	0.705	17.9	9.7	●		2.75	TID*170...
DMH180	0.709	18	10.3	●		2.73	TID*180...
DMH181	0.713	18.1	10.3	●		2.75	TID*180...
DMH183	0.720	18.3	10.3	●		2.78	TID*180...
DMH185	0.728	18.5	10.3	●		2.82	TID*180...
DMH187	0.736	18.7	10.3	●		2.86	TID*180...
DMH190	0.748	19	10.8	●		2.88	TID*190...
DMH191	0.752	19.1	10.8	●		2.90	TID*190...
DMH192	0.756	19.2	10.8	●		2.92	TID*190...
DMH193	0.760	19.3	10.8	●		2.93	TID*190...
DMH194	0.764	19.4	10.8	●		2.95	TID*190...
DMH195	0.768	19.5	10.8	●		2.97	TID*190...
DMH196	0.772	19.6	10.8	●		2.99	TID*190...
DMH197	0.776	19.7	10.8	●		3.01	TID*190...
DMH200	0.787	20	11.4	●		3.02	TID*200...
DMH205	0.807	20.5	11.4	●		3.11	TID*200...
DMH210	0.827	21.1	11.98	●		3.18	TID*210...
DMH215	0.846	21.5	11.98	●		3.27	TID*210...
DMH220	0.866	22	12.56	●		3.32	TID*220...
DMH225	0.886	22.5	12.56	●		3.41	TID*220...
DMH230	0.906	23	13.13	●		3.46	TID*230...
DMH235	0.925	23.5	13.13	●		3.55	TID*230...
DMH240	0.945	24	13.7	●		3.62	TID*240...
DMH245	0.965	24.5	13.7	●		3.71	TID*240...
DMH250	0.984	25	14.3	●		3.8	TID*250...
DMH255	1.004	25.5	14.3	●		3.89	TID*250...

ø0.236" - ø0.783" = 2 pieces per package  
 ø0.787" - ø1.004" = 1 piece per package

● : Line up

## DMN (Non-ferrous metals drilling)

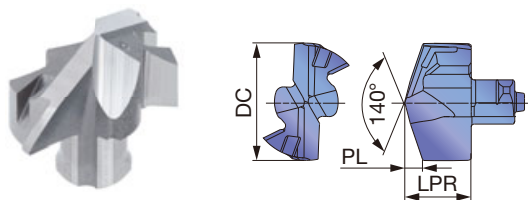

Tool diameter (in)	Head diameter tolerance (in)
ø0.394" - ø0.689"	+0.0004" / 0
ø0.709" - ø0.768"	+0.0005" / 0
Tool diameter (mm)	Head diameter tolerance (mm)
ø10 - ø17.5	+0.01 / 0
ø18 - ø19.9	+0.012 / 0

Material	Steel	Stainless	Cast iron	Non-ferrous	Superalloys	Hard materials
P	●					
M		●				
K			●			
N				★		
S					★	
H						☆

★ : First choice  
☆ : Second choice

Designation	DC (in)	DC (mm)	LPR (mm)	Coated		PL (mm)	Body
				KS15F			
DMN100	0.394	10	6.05	●		1.47	TID*100...
DMN102	0.402	10.2	6.05	●		1.51	TID*100...
DMN105	0.413	10.5	6.05	●		1.56	TID*105...
DMN108	0.425	10.8	6.05	●		1.62	TID*105...
DMN110	0.433	11	6.45	●		1.67	TID*110...
DMN115	0.453	11.5	6.45	●		1.76	TID*115...
DMN120	0.472	12	6.8	●		1.82	TID*120...
DMN123	0.484	12.3	6.8	●		1.87	TID*120...
DMN125	0.492	12.5	6.8	●		1.91	TID*125...
DMN126	0.496	12.6	6.8	●		1.93	TID*125...
DMN127	0.500	12.7	6.8	●		1.95	TID*125...
DMN130	0.512	13	7.4	●		1.96	TID*130...
DMN135	0.531	13.5	7.4	●		2.05	TID*135...
DMN138	0.543	13.8	7.4	●		2.11	TID*135...
DMN140	0.551	14	7.95	●		2.12	TID*140...
DMN142	0.559	14.2	7.95	●		2.16	TID*140...
DMN145	0.571	14.5	7.95	●		2.21	TID*145...
DMN150	0.591	15	8.53	●		2.27	TID*150...
DMN152	0.598	15.2	8.53	●		2.31	TID*150...
DMN155	0.610	15.5	8.53	●		2.36	TID*150...
DMN158	0.622	15.8	8.53	●		2.42	TID*150...
DMN159	0.626	15.9	8.53	●		2.43	TID*150...
DMN160	0.630	16	9.1	●		2.42	TID*160...
DMN163	0.642	16.3	9.1	●		2.47	TID*160...
DMN165	0.650	16.5	9.1	●		2.51	TID*160...
DMN170	0.669	17	9.7	●		2.59	TID*170...
DMN175	0.689	17.5	9.7	●		2.68	TID*170...
DMN180	0.709	18	10.3	●		2.73	TID*180...
DMN185	0.728	18.5	10.3	●		2.82	TID*180...
DMN190	0.748	19	10.8	●		2.88	TID*190...
DMN195	0.768	19.5	10.8	●		2.97	TID*190...

ø0.394" - ø0.768" = 2 pieces per package

● : Line up



# STANDARD CUTTING CONDITIONS

ISO	Workpiece material	Hardness	Cutting speed Vc (sfm)	Feed: f (ipr)									
				Tool diameter: DC (in)									
				ø0.157" - ø0.173"	ø0.177" - ø0.193"	ø0.197" - ø0.232"	ø0.236" - ø0.311"	ø0.315" - ø0.390"	ø0.394" - ø0.469"	ø0.472" - ø0.547"	ø0.551" - ø0.626"	ø0.630" - ø0.783"	ø0.787" - ø1.020"
P	Low carbon steels (C < 0.3) 1018, 1020, 1026, etc.	- 200 HB	262 - 459	0.002 - 0.003	0.002 - 0.003	0.003 - 0.005	0.004 - 0.005	0.005 - 0.010	0.006 - 0.011	0.007 - 0.012	0.008 - 0.014	0.010 - 0.018	0.010 - 0.018
	High carbon steels (C > 0.3) 1045, 1055, etc.	- 300 HB	230 - 394	0.002 - 0.003	0.002 - 0.003	0.003 - 0.005	0.004 - 0.005	0.005 - 0.010	0.006 - 0.011	0.007 - 0.012	0.008 - 0.014	0.010 - 0.018	0.010 - 0.018
	Low alloy steels 4140, etc.	- 200 HB	230 - 394	0.002 - 0.002	0.002 - 0.003	0.003 - 0.005	0.003 - 0.005	0.004 - 0.010	0.006 - 0.011	0.006 - 0.013	0.007 - 0.014	0.009 - 0.016	0.010 - 0.018
	Alloy steels 8620, etc.	- 300 HB	131 - 295	0.002 - 0.003	0.002 - 0.003	0.003 - 0.005	0.003 - 0.005	0.004 - 0.010	0.006 - 0.011	0.006 - 0.013	0.007 - 0.014	0.009 - 0.016	0.010 - 0.018
M	Stainless steels 304SS, 316SS, etc.	- 250 HB	98 - 230	-	-	0.002 - 0.003	0.003 - 0.004	0.004 - 0.006	0.005 - 0.007	0.006 - 0.008	0.006 - 0.009	0.006 - 0.010	0.007 - 0.012
K	Gray cast irons Class 25, etc.	150 - 250 HB	262 - 591	0.002 - 0.003	0.002 - 0.003	0.004 - 0.006	0.005 - 0.007	0.006 - 0.012	0.008 - 0.014	0.010 - 0.016	0.012 - 0.018	0.014 - 0.022	0.014 - 0.024
	Ductile cast irons 100-70-03, etc.	150 - 250 HB	262 - 459	0.002 - 0.003	0.002 - 0.003	0.004 - 0.006	0.005 - 0.007	0.006 - 0.012	0.008 - 0.014	0.010 - 0.016	0.012 - 0.018	0.014 - 0.022	0.014 - 0.024
N	Aluminum alloys	-	262 - 722	-	-	-	0.004 - 0.008	0.008 - 0.014	0.010 - 0.016	0.012 - 0.018	0.014 - 0.02	0.016 - 0.024	0.020 - 0.030
S	Titanium alloys Ti-6Al-4V, etc.	- 40 HRC	66 - 164	-	-	-	0.002 - 0.003	0.002 - 0.005	0.003 - 0.006	0.004 - 0.011	0.005 - 0.008	0.006 - 0.009	0.007 - 0.011
	Nickel-based alloys	- 40 HRC	66 - 164	-	-	-	0.002 - 0.003	0.002 - 0.004	0.003 - 0.005	0.004 - 0.006	0.005 - 0.007	0.005 - 0.009	0.006 - 0.009
H	Hardened steel	- 50 HRC	66 - 164	-	-	-	0.002 - 0.003	0.002 - 0.005	0.003 - 0.006	0.004 - 0.007	0.005 - 0.008	0.006 - 0.009	0.006 - 0.010

- Cutting conditions in the above table show standard cutting conditions
- Cutting conditions may change due to the rigidity and power of the machine and the workpiece material
- Machined hole diameter may change depending upon the rigidity of the machine tool or cutting conditions

## Over 2xD drilling without internal coolant

In an environment without internal coolant, an external coolant supply is required. It is recommended to reduce the cutting conditions based on the material, diameter, and hole depth. Over 2xD drill, a step or pecking cycle operation is recommended in order to cool the cutting edge and improve chip evacuation.

2xD drilling in P material

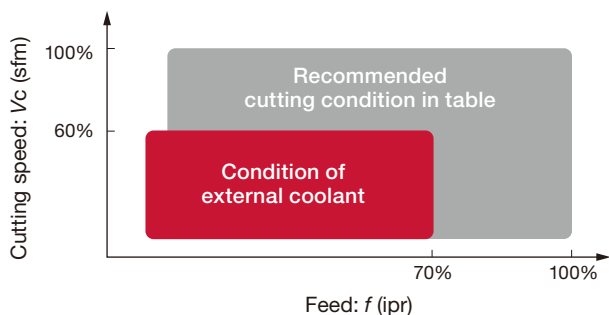

## Over 8xD drilling

For drilling operations over 8xD a DMC head is recommended to achieve stable drill machining. When drilling a through hole with 8xD to 12xD depth, the feed rate at entry and before drill exit should be 40-50% lower than regular feed rate. The length of machining with the lower feed should be similar to LPR length of the head. After drill entry it is possible to increase the feed depending on target productivity.

12xD drilling in P material of through hole depth DC = 0.472"

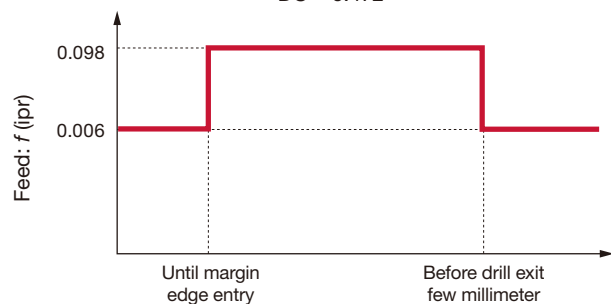

## CRITERIA FOR THE END OF DRILL-BODY LIFE

For your safety, it is recommended that drill bodies are replaced with a new drill body once they reach fatigue tool life. To determine the fatigue life, measure the torque value required to unlock the drill head with a torque driver. The exclusive clamp key (sold separately) should be used to measure the unlocking torque value. When the unlocking torque value is equal to or smaller than the values listed below for the respective head size, replace the drill body with a new one.

Clamping key for measuring un-clamping torque:  
KHS-TID10-19.99



\* The clamping key can be connect with general torque drivers.



Head Designation	Recommended value of un-clamping torque that means usable limit of a drill body (lbf-ft)
DM*100-109	0.15
DM*110-119	0.15
DM*120-129	0.18
DM*130-139	0.18
DM*140-149	0.22
DM*150-159	0.22
DM*160-169	0.26
DM*170-179	0.26
DM*180-189	0.3
DM*190-199	0.3

# DRILL FORCE TISU L/D=3

Exchangeable head drill, L/D = 3, flange type

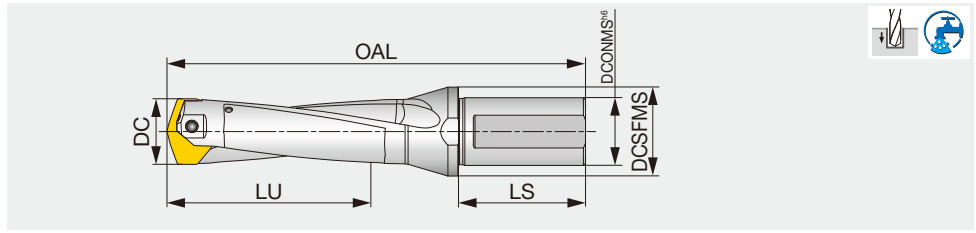

Inch	DC	DCONMS	DCSFMS	LU	LS	OAL		Pocket size	Head
						SMP	SMF		
TISU1024F1250-3	1.024 - 1.059	1.250	1.772	3.257	2.362	7.677	7.713	26	SM*26*
TISU1063F1250-3	1.063 - 1.098	1.250	1.772	3.382	2.362	7.815	7.850	27	SM*27*
TISU1102F1250-3	1.102 - 1.138	1.250	1.772	3.508	2.362	7.968	7.992	28	SM*28*
TISU1142F1250-3	1.142 - 1.177	1.250	1.772	3.633	2.362	8.106	8.13	29	SM*29*
TISU1181F1250-3	1.181 - 1.217	1.250	1.772	3.758	2.362	8.256	8.272	30	SM*30*
TISU1220F1250-3	1.220 - 1.256	1.250	1.772	3.883	2.362	8.394	8.409	31	SM*31*
TISU1260F1500-3	1.260 - 1.295	1.500	2.165	4.009	2.677	9.055	9.067	32	SM*32*
TISU1299F1500-3	1.299 - 1.335	1.500	2.165	4.134	2.677	9.193	9.205	33	SM*33*
TISU1339F1500-3	1.339 - 1.374	1.500	2.165	4.260	2.677	9.331	9.343	34	SM*34*
TISU1378F1500-3	1.378 - 1.413	1.500	2.165	4.385	2.677	9.484	9.488	35	SM*35*
TISU1417F1500-3	1.417 - 1.453	1.500	2.165	4.510	2.677	9.622	9.626	36	SM*36*
TISU1457F1500-3	1.457 - 1.492	1.500	2.165	4.635	2.677	9.760	9.764	37	SM*37*
TISU1496F1500-3	1.496 - 1.531	1.500	2.165	4.760	2.677	9.917	9.913	38	SM*38*
TISU1535F1500-3	1.535 - 1.571	1.500	2.165	4.885	2.677	10.055	10.051	39	SM*39*
TISU1575F1500-3	1.575 - 1.614	1.500	2.165	5.011	2.677	10.193	10.189	40	SM*40*

Tool diameter (in)	Hole diameter tolerance (in)*	
ø1.024" - ø1.177"	+0.0020" / 0	- The overall length (OAL) differs based on each head geometry.
ø1.181" - ø1.614"	+0.0024" / 0	

\*Just for reference

## SPARE PARTS



Designation	Clamping screw	Wrench		Screw for side port	Plug*
		Torx bit	Grip		
TISU1024F... - TISU1063F...	TS50230D3	BLDT20/S7	H-TB2W	NPTF1/4	SL32IN
TISU1102F... - TISU1142F...	TS50250D35	BLDT25/S7	H-TB2W	NPTF1/4	SL32IN
TISU1181F... - TISU1220F...	TS60265D4	BLDT25/S7	H-TB2W	NPTF1/4	SL32IN
TISU1260F... - TISU1339F...	TS60285D42	BLDT25/S7	H-TB2W	NPTF1/4	SL38IN
TISU1378F... - TISU1457F...	TS60320D5	BLDT25/S7	H-TB2W	NPTF1/4	SL38IN
TISU1496F... - TISU1575F...	TS80340D6	BLDT25/S7	H-TB2W	NPTF1/4	SL38IN

\*Optional part  
Inner thread size: NPTF1/4

Recommended clamping torque : TS50230D3= 3.69 lb-ft, 5 N-m, TS50250D35= 4.06 lb-ft, 5.5N-m, TS60265D4= 4.43 lb-ft, 6N-m, TS60285D42= 4.43 lb-ft, 6N-m, TS60320D5= 4.43 lb-ft, 6N-m, TS80340D6= 5.16 lb-ft, 7N-m

Reference pages: Head → **J043 - J044**  
Standard cutting conditions → **J045**

# TIS L/D=3

Exchangeable head drill, L/D = 3, flange type

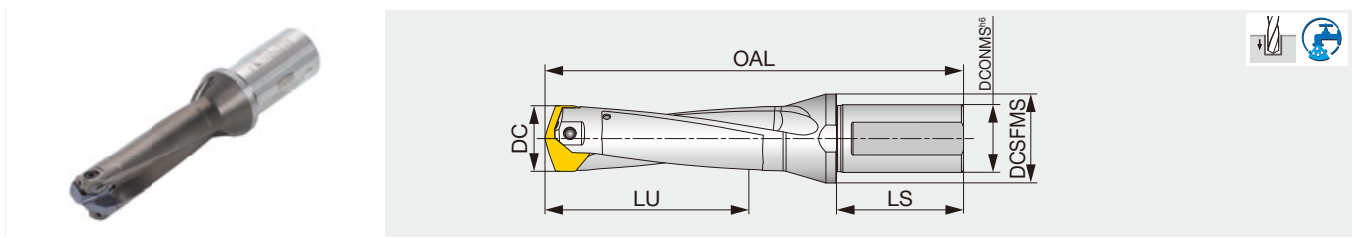

Metric	DC	DCONMS	DCSFMS	LU	LS	OAL		Pocket size	Head
						SMP	SMF		
TIS200F25-3	20 - 20.9	25	32	63.1	56	148.1	148.4	20	SM*20*
TIS210F25-3	21 - 21.9	25	32	66.3	56	151.1	151.4	21	SM*21*
TIS220F25-3	22 - 22.9	25	32	69.4	56	154.4	154.5	22	SM*22*
TIS230F25-3	23 - 23.9	25	32	72.6	56	157.4	157.5	23	SM*23*
TIS240F32-3	24 - 24.9	32	40	75.7	60	170.7	170.7	24	SM*24*
TIS250F32-3	25 - 25.9	32	40	78.9	60	173.7	173.7	25	SM*25*
TIS260F32-3	26 - 26.9	32	40	82	60	177	177.9	26	SM*26*
TIS270F32-3	27 - 27.9	32	40	85.2	60	180	180.9	27	SM*27*
TIS280F32-3	28 - 28.9	32	40	88.4	60	188.4	189.3	28	SM*28*
TIS290F32-3	29 - 29.9	32	40	91.5	60	191.4	-	29	SM*29*
TIS300F32-3	30 - 30.9	32	42	94.7	60	194.7	195.1	30	SM*30*
TIS310F32-3	31 - 31.9	32	42	97.9	60	197.7	198.1	31	SM*31*
TIS320F40-3	32 - 32.9	40	48	101	68	211	211.3	32	SM*32*
TIS330F40-3	33 - 33.9	40	48	104.2	68	214	214.3	33	SM*33*
TIS340F40-3	34 - 34.9	40	48	107.3	68	217	217.3	34	SM*34*
TIS350F40-3	35 - 35.9	40	48	110.4	68	220.4	220.5	35	SM*35*
TIS360F40-3	36 - 36.9	40	48	113.6	68	223.4	223.5	36	SM*36*
TIS370F40-3	37 - 37.9	40	48	116.8	68	226.4	-	37	SM*37*
TIS380F40-3	38 - 38.9	40	50	119.9	68	234.9	-	38	SM*38*
TIS390F40-3	39 - 39.9	40	50	123.1	68	237.9	237.8	39	SM*39*
TIS400F40-3	40 - 41	40	50	126.3	68	240.9	240.8	40	SM*40*

Tool diameter (mm)	Hole diameter tolerance (mm)*
ø20 - ø29.9	+0.05 / 0
ø30 - ø41	+0.06 / 0

- The overall length (OAL) differs based on each head geometry.

\*Just for reference

## SPARE PARTS



Designation	Clamping screw	Wrench	
		Torx Bit	Grip
TIS200F25-*, TIS210F25-*	TS40178D25	BLDT20/S7	H-TB2W
TIS220F25-*, TIS230F25-*	TS40198D28	BLDT20/S7	H-TB2W
TIS240F32-*, TIS250F32-*	TS40210D3	BLDT20/S7	H-TB2W
TIS260F32-*, TIS270F32-*	TS50230D3	BLDT20/S7	H-TB2W
TIS280F32-*, TIS290F32-*	TS50250D35	BLDT25/S7	H-TB2W
TIS300F32-*, TIS310F32-*	TS60265D4	BLDT25/S7	H-TB2W
TIS320F40-*, TIS330F40-*, TIS340F40-*	TS60285D42	BLDT25/S7	H-TB2W
TIS350F40-*, TIS360F40-*, TIS370F40-*	TS60320D5	BLDT25/S7	H-TB2W
TIS380F40-*, TIS390F40-*, TIS400F40-*	TS80340D6	BLDT25/S7	H-TB2W

Recommended clamping torque (N·m):  
 TS40178D25, TS40198D28, TS40210D3 = 4.5,  
 TS50230D3 = 5, TS50250D35 = 5.5,  
 TS60265D4, TS60285D42, TS60320D5 = 6,  
 TS80340D6 = 7

Reference pages: Head → **J043 - J044**  
 Standard cutting conditions → **J045**



# DRILL F<sup>OR</sup>CE MEISTER

## TISU L/D=5

Exchangeable head drill, L/D = 5, flange type

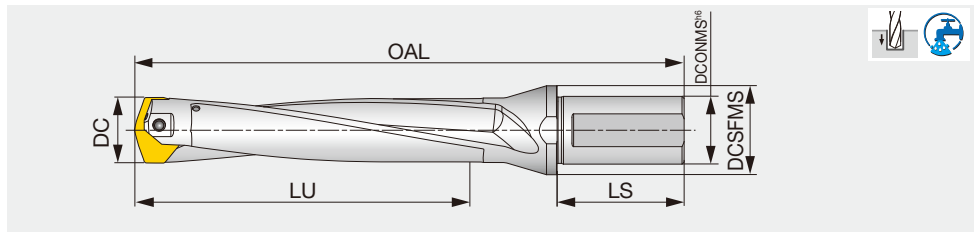

Inch	DC	DCONMS	DCSFMS	LU	LS	OAL		Pocket size	Head
						SMP	SMF		
TISU1024F1250-5	1.024 - 1.059	1.250	1.772	5.304	2.362	9.724	9.760	26	SM*26*
TISU1063F1250-5	1.063 - 1.098	1.250	1.772	5.508	2.362	9.941	9.976	27	SM*27*
TISU1102F1250-5	1.102 - 1.138	1.250	1.772	5.713	2.362	10.173	10.197	28	SM*28*
TISU1142F1250-5	1.142 - 1.177	1.250	1.772	5.917	2.362	10.39	10.413	29	SM*29*
TISU1181F1250-5	1.181 - 1.217	1.250	1.772	6.121	2.362	10.618	10.634	30	SM*30*
TISU1220F1250-5	1.220 - 1.256	1.250	1.772	6.324	2.362	10.835	10.850	31	SM*31*
TISU1260F1500-5	1.260 - 1.295	1.500	2.165	6.528	2.677	11.575	11.587	32	SM*32*
TISU1299F1500-5	1.299 - 1.335	1.500	2.165	6.732	2.677	11.791	11.803	33	SM*33*
TISU1339F1500-5	1.339 - 1.374	1.500	2.165	6.937	2.677	12.008	12.020	34	SM*34*
TISU1378F1500-5	1.378 - 1.413	1.500	2.165	7.141	2.677	12.24	12.244	35	SM*35*
TISU1417F1500-5	1.417 - 1.453	1.500	2.165	7.345	2.677	12.457	12.461	36	SM*36*
TISU1457F1500-5	1.457 - 1.492	1.500	2.165	7.548	2.677	12.673	12.677	37	SM*37*
TISU1496F1500-5	1.496 - 1.531	1.500	2.165	7.752	2.677	12.909	12.906	38	SM*38*
TISU1535F1500-5	1.535 - 1.571	1.500	2.165	7.956	2.677	13.126	13.122	39	SM*39*
TISU1575F1500-5	1.575 - 1.614	1.500	2.165	8.161	2.677	13.343	13.339	40	SM*40*

Tool diameter (in)	Hole diameter tolerance (in)*	
ø1.024" - ø1.177"	+0.0030" / 0	- The overall length (OAL) differs based on each head geometry.
ø1.181" - ø1.614"	+0.0035" / 0	

\*Just for reference

### SPARE PARTS



Designation	Clamping screw	Wrench		Screw for side port	Plug*
		Torx bit	Grip		
TISU1024F... - TISU1063F...	TS50230D3	BLDT20/S7	H-TB2W	NPTF1/4	SL32IN
TISU1102F... - TISU1142F...	TS50250D35	BLDT25/S7	H-TB2W	NPTF1/4	SL32IN
TISU1181F... - TISU1220F...	TS60265D4	BLDT25/S7	H-TB2W	NPTF1/4	SL32IN
TISU1260F... - TISU1339F...	TS60285D42	BLDT25/S7	H-TB2W	NPTF1/4	SL38IN
TISU1378F... - TISU1457F...	TS60320D5	BLDT25/S7	H-TB2W	NPTF1/4	SL38IN
TISU1496F... - TISU1575F...	TS80340D6	BLDT25/S7	H-TB2W	NPTF1/4	SL38IN

\*Optional part  
Inner thread size: NPTF1/4

Recommended clamping torque : TS50230D3= 3.69 lb-ft, 5 N-m, TS50250D35= 4.06 lb-ft, 5.5 N-m, TS60265D4= 4.43 lb-ft, 6 N-m, TS60285D42= 4.43 lb-ft, 6 N-m, TS60320D5= 4.43 lb-ft, 6 N-m, TS80340D6= 5.16 lb-ft, 7 N-m

Reference pages: Head → **J043 - J044**  
Standard cutting conditions → **J045**

# TIS L/D=5

Exchangeable head drill, L/D = 5, flange type

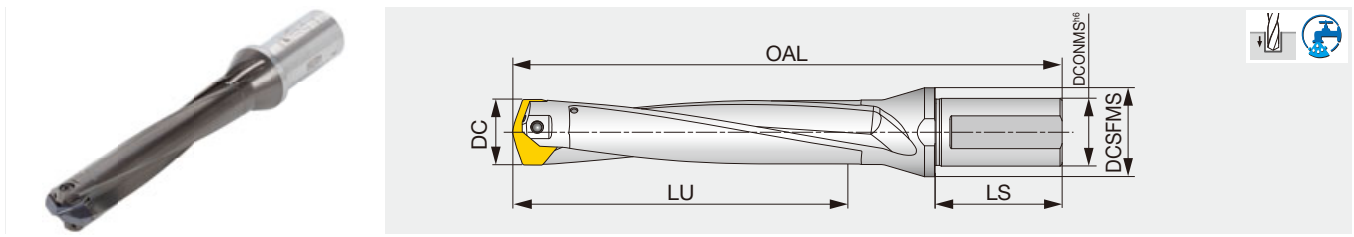

Metric	DC	DCONMS	DCSFMS	LU	LS	OAL			Head
						SMP	SMF	Pocket size	
TIS200F25-5	20 - 20.9	25	32	103.1	56	188.1	188.4	20	SM*20*
TIS210F25-5	21 - 21.9	25	32	108.3	56	193.1	193.4	21	SM*21*
TIS220F25-5	22 - 22.9	25	32	113.4	56	198.4	198.5	22	SM*22*
TIS230F25-5	23 - 23.9	25	32	118.6	56	203.4	203.5	23	SM*23*
TIS240F32-5	24 - 24.9	32	40	123.7	60	218.7	218.7	24	SM*24*
TIS250F32-5	25 - 25.9	32	40	128.9	60	223.7	223.7	25	SM*25*
TIS260F32-5	26 - 26.9	32	40	134	60	229	229.9	26	SM*26*
TIS270F32-5	27 - 27.9	32	40	139.2	60	234	234.9	27	SM*27*
TIS280F32-5	28 - 28.9	32	40	144.4	60	244.4	245.3	28	SM*28*
TIS290F32-5	29 - 29.9	32	40	149.5	60	249.4	-	29	SM*29*
TIS300F32-5	30 - 30.9	32	42	154.7	60	254.7	255.1	30	SM*30*
TIS310F32-5	31 - 31.9	32	42	159.9	60	259.7	260.1	31	SM*31*
TIS320F40-5	32 - 32.9	40	48	165	68	275	275.3	32	SM*32*
TIS330F40-5	33 - 33.9	40	48	170.2	68	280	280.3	33	SM*33*
TIS340F40-5	34 - 34.9	40	48	175.3	68	285	285.3	34	SM*34*
TIS350F40-5	35 - 35.9	40	48	180.4	68	290.4	290.5	35	SM*35*
TIS360F40-5	36 - 36.9	40	48	185.6	68	295.4	295.5	36	SM*36*
TIS370F40-5	37 - 37.9	40	48	190.8	68	300.4	-	37	SM*37*
TIS380F40-5	38 - 38.9	40	50	195.9	68	310.9	-	38	SM*38*
TIS390F40-5	39 - 39.9	40	50	201.1	68	315.9	315.8	39	SM*39*
TIS400F40-5	40 - 41	40	50	206.3	68	320.9	320.8	40	SM*40*

Tool diameter (mm)	Hole diameter tolerance (mm)*
ø20 - ø29.9	+0.08 / 0
ø30 - ø41	+0.09 / 0

- The overall length (OAL) differs based on each head geometry.

\*Just for reference

## SPARE PARTS



Designation	Clamping screw	Wrench	
		Torx Bit	Grip
TIS200F25-*, TIS210F25-*	TS40178D25	BLDT20/S7	H-TB2W
TIS220F25-*, TIS230F25-*	TS40198D28	BLDT20/S7	H-TB2W
TIS240F32-*, TIS250F32-*	TS40210D3	BLDT20/S7	H-TB2W
TIS260F32-*, TIS270F32-*	TS50230D3	BLDT20/S7	H-TB2W
TIS280F32-*, TIS290F32-*	TS50250D35	BLDT25/S7	H-TB2W
TIS300F32-*, TIS310F32-*	TS60265D4	BLDT25/S7	H-TB2W
TIS320F40-*, TIS330F40-*, TIS340F40-*	TS60285D42	BLDT25/S7	H-TB2W
TIS350F40-*, TIS360F40-*, TIS370F40-*	TS60320D5	BLDT25/S7	H-TB2W
TIS380F40-*, TIS390F40-*, TIS400F40-*	TS80340D6	BLDT25/S7	H-TB2W

Recommended clamping torque:  
 TS40178D25, TS40198D28, TS40210D3 = 4.5 N-m,  
 TS50230D3 = 5 N-m, TS50250D35 = 5.5 N-m,  
 TS60265D4, TS60285D42, TS60320D5 = 6 N-m,  
 TS80340D6 = 7 N-m

Reference pages: Head → **J043 - J044**  
 Standard cutting conditions → **J045**

Exchangeable head drill, L/D = 8, flange type

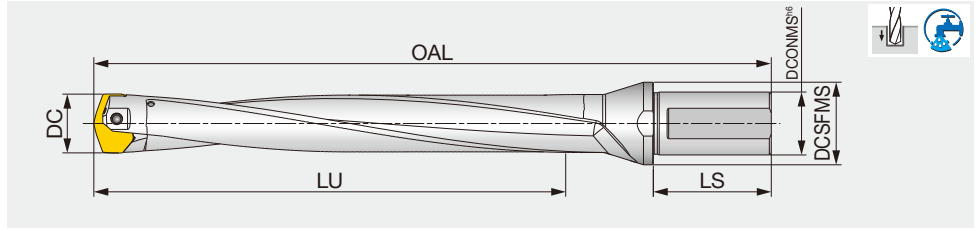

Metric	DC	DCONMS	DCSFMS	LU	LS	OAL			Head
						SMP	SMF	Pocket size	
TIS260F32-8	26 - 26.9	32	40	212	60	307	307.9	26	SM*26*
TIS270F32-8	27 - 27.9	32	40	220.2	60	315	315.9	27	SM*27*
TIS290F32-8	29 - 29.9	32	40	236.5	60	336.4	-	29	SM*29*
TIS300F32-8	30 - 30.9	32	42	244.7	60	344.7	345.1	30	SM*30*
TIS320F40-8	32 - 32.9	40	48	261	68	371.7	372	32	SM*32*
TIS330F40-8	33 - 33.9	40	48	269.2	68	379	379.3	33	SM*33*

Tool diameter (mm)	Hole diameter tolerance (mm)*	
ø26 - ø29.9	+0.08 / 0	- The overall length (OAL) differs based on each head geometry.
ø30 - ø33.9	+0.09 / 0	

\*Just for reference

### SPARE PARTS



Designation	Clamping screw	Wrench	
		Torx Bit	Grip
TIS260F32-*, TIS270F32-*	TS50230D3	BLDT20/S7	H-TB2W
TIS290F32-*	TS50250D35	BLDT25/S7	H-TB2W
TIS300F32-*	TS60265D4	BLDT25/S7	H-TB2W
TIS320F40-*, TIS330F40-*	TS60285D42	BLDT25/S7	H-TB2W

Recommended clamping torque: TS50230D3 = 5 N-m, TS50250D35 = 5.5 N-m, TS60265D4, TS60285D42 = 6 N-m

### ● Tips when using 8xD drills

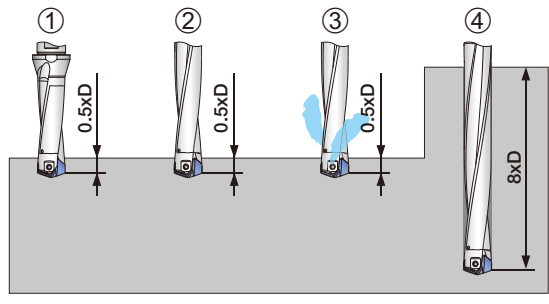

- ① Drill a pilot hole to the depth of 0.5xD (3xD drill body is recommended). The same head diameter should be used for the pre-hole and the main drilling process.
- ② Rotate the drill at a low speed (eg. 100 rpm). While maintaining the drill speed, slowly feed into the pilot hole for several millimeters from the entry.
- ③ Activate the internal coolant and increase the drill rotation to the required speed.
- ④ Drill to the required depth using the recommended cutting parameters.

Reference pages: Head → **J043 - J044**  
Standard cutting conditions → **J045**





## SMF (Flat geometry head)

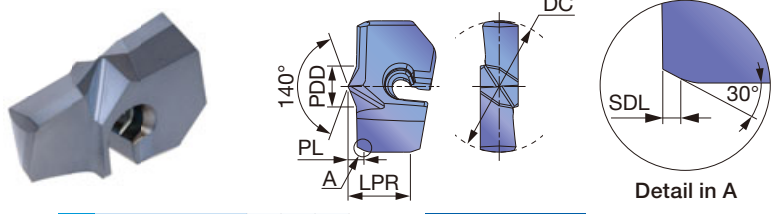

P	Steel	★	
M	Stainless	★	
K	Cast iron	★	
N	Non-ferrous	☆	
S	Superalloys	★	
H	Hard materials	★	

Tool diameter (in)	Head diameter tolerance (in)	Tool diameter (mm)	Head diameter tolerance (mm)
ø0.787" - ø1.177"	+0.0006" / -0.0006"	ø20 - ø29.9	+0.014 / -0.015
ø1.181" - ø1.614"	+0.0006" / -0.0008"	ø30 - ø41	+0.014 / -0.02

★ : First choice  
 ☆ : Second choice

Designation	DC (in)	DC (mm)	LPR (in)	Coated		SDL (in)	PL (in)	PDD (in)	Pocket size	Body
				AH9130						
SMF200	0.787	20	0.387	●		0.028	0.086	0.327	20	TIS200F25-*
SMF205	0.807	20.5	0.378	●		0.028	0.086	0.327	20	TIS200F25-*
SMF210	0.827	21	0.370	●		0.028	0.086	0.327	21	TIS210F25-*
SMF215	0.846	21.5	0.362	●		0.028	0.086	0.327	21	TIS210F25-*
SMF220	0.866	22	0.416	●		0.028	0.094	0.354	22	TIS220F25-*
SMF225	0.886	22.5	0.407	●		0.028	0.094	0.354	22	TIS220F25-*
SMF227	0.894	22.7	0.404	●		0.028	0.094	0.354	22	TIS220F25-*
SMF230	0.906	23	0.399	●		0.028	0.094	0.354	23	TIS230F25-*
SMF235	0.925	23.5	0.391	●		0.028	0.094	0.354	23	TIS230F25-*
SMF238	0.937	23.8	0.386	●		0.028	0.094	0.354	23	TIS230F25-*
SMF240	0.945	24	0.419	●		0.028	0.099	0.394	24	TIS240F32-*
SMF242	0.953	24.2	0.415	●		0.028	0.099	0.394	24	TIS240F32-*
SMF245	0.965	24.5	0.410	●		0.028	0.099	0.394	24	TIS240F32-*
SMF250	0.984	25	0.402	●		0.028	0.099	0.394	25	TIS250F32-*
SMF255	1.004	25.5	0.394	●		0.028	0.099	0.394	25	TIS250F32-*
SMF260	1.024	26	0.485	●		0.028	0.098	0.413	26	TIS260F32-*
SMF265	1.043	26.5	0.477	●		0.028	0.098	0.413	26	TIS260F32-*
SMF270	1.063	27	0.469	●		0.028	0.098	0.413	27	TIS270F32-*
SMF275	1.083	27.5	0.460	●		0.028	0.098	0.413	27	TIS270F32-*
SMF280	1.102	28	0.483	●		0.028	0.107	0.457	28	TIS280F32-*
SMF290	1.142	29	0.467	●		0.028	0.107	0.457	29	TIS290F32-*
SMF295	1.161	29.5	0.459	●		0.028	0.107	0.457	29	TIS290F32-*
SMF296	1.165	29.6	0.457	●		0.028	0.107	0.457	29	TIS290F32-*
SMF300	1.181	30	0.569	●		0.028	0.110	0.488	30	TIS300F32-*
SMF310	1.220	31	0.553	●		0.028	0.110	0.488	31	TIS310F32-*
SMF315	1.240	31.5	0.544	●		0.028	0.110	0.488	31	TIS310F32-*
SMF320	1.260	32	0.581	●		0.028	0.123	0.535	32	TIS320F40-*
SMF325	1.280	32.5	0.573	●		0.028	0.123	0.535	32	TIS320F40-*
SMF330	1.299	33	0.565	●		0.028	0.123	0.535	33	TIS330F40-*
SMF340	1.339	34	0.548	●		0.028	0.123	0.535	34	TIS340F40-*
SMF345	1.358	34.5	0.540	●		0.028	0.123	0.535	34	TIS340F40-*
SMF350	1.378	35	0.651	●		0.028	0.130	0.575	35	TIS350F40-*
SMF355	1.398	35.5	0.643	●		0.028	0.130	0.575	35	TIS350F40-*
SMF360	1.417	36	0.635	●		0.028	0.130	0.575	36	TIS360F40-*
SMF365	1.437	36.5	0.626	●		0.028	0.130	0.575	36	TIS360F40-*
SMF370	1.457	37	0.618	●		0.028	0.130	0.575	37	TIS370F40-*
SMF380	1.496	38	0.663	●		0.028	0.137	0.626	38	TIS380F40-*
SMF390	1.535	39	0.647	●		0.028	0.137	0.626	39	TIS390F40-*
SMF400	1.575	40	0.630	●		0.028	0.137	0.626	40	TIS400F40-*
SMF402	1.583	40.2	0.627	●		0.028	0.137	0.626	40	TIS400F40-*
SMF410	1.614	41	0.614	●		0.028	0.137	0.626	40	TIS400F40-*

No drill body modification is needed when mounting SMF drill head. ●: Line up  
 Do not regrind. SMF drill heads are not designed to be regrind. Package quantity = 1 pc

### Counterbore dimensions for bolt holes

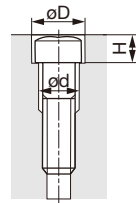

Thread size	M16	M20	M22	M24
øD (mm)	26	32	35	39
H (mm)	17.5	21.5	23.5	25.5
ød (mm)	18	22	24	26
Applicable tool	SMF260	SMF320	SMF350	SMF390



## STANDARD CUTTING CONDITIONS

ISO	Workpiece materials	Hardness	Cutting speed Vc (sfm)	Feed: f (ipr)		
				ø0.787" - ø1.177"	ø1.181" - ø1.413"	ø1.417" - ø1.614"
P	Low carbon steels 1015, etc.	- 200 HB	262 - 459	0.008 - 0.020	0.008 - 0.020	0.010 - 0.022
	Carbon steels, Alloy steels 1055, 4140, etc.	- 300 HB	262 - 427	0.008 - 0.020	0.008 - 0.020	0.010 - 0.022
	Prehardened steels NAK80, PX5, etc.	30 - 40 HRC	164 - 328	0.008 - 0.020	0.008 - 0.020	0.010 - 0.022
M	Stainless steels S30400, etc.	-	131 - 262	0.006 - 0.012	0.006 - 0.012	0.008 - 0.014
K	Gray cast irons No.250B, No.300B, etc.	150 - 250 HB	262 - 591	0.010 - 0.022	0.010 - 0.022	0.012 - 0.024
	Ductile cast irons 60-40-15, 80-55-06, etc.	150 - 250 HB	262 - 459	0.010 - 0.022	0.010 - 0.022	0.012 - 0.024
N	Non ferrous materials	-	328 - 656	0.016 - 0.024	0.016 - 0.024	0.020 - 0.028
S	Heat-resistant alloy Inconel718, etc.	- 40 HRC	66 - 164	0.004 - 0.008	0.004 - 0.008	0.004 - 0.010
	Titanium alloys Ti-6Al-4V, etc.	- 40 HRC	98 - 197	0.004 - 0.008	0.004 - 0.008	0.004 - 0.010
H	Hardened materials	- 50 HRC	66 - 197	0.004 - 0.008	0.004 - 0.008	0.004 - 0.010

## TAILOR MADE DRILL BODY

Special drill bodies featuring chamfering or counter boring capabilities with indexable insert and head. Reduce down time and tool management compared to solid drill.

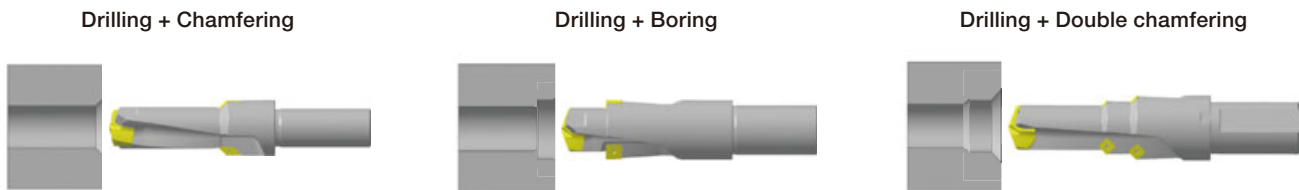

## REGRINDING HOLDER

### SMP-GH

Regrinding holder for SMP drill heads

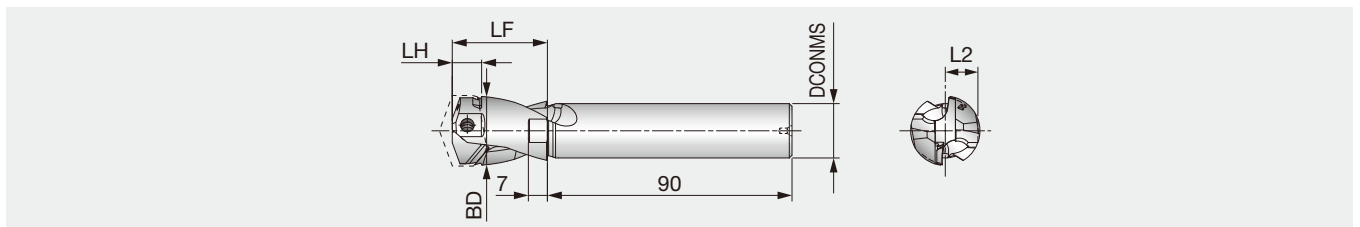

Inch	DCONMS	BD	LF	LH	L2	Pocket size	Head
SMP260-279-GH	0.787	1.004	1.378	0.425	0.472	26, 27	SMP260-SMP279
SMP280-299-GH	0.787	1.083	1.378	0.425	0.512	28, 29	SMP280-SMP299
SMP300-319-GH	0.787	1.161	1.378	0.512	0.551	30, 31	SMP300-SMP319
SMP320-349-GH	0.787	1.240	1.378	0.512	0.591	32, 33, 34	SMP320-SMP349
SMP350-379-GH	0.787	1.358	1.575	0.579	0.650	35, 36, 37	SMP350-SMP379
SMP380-410-GH	0.787	1.476	1.575	0.594	0.709	38, 39, 40	SMP380-SMP410

The exclusive holders with short length for regrinding of SMP heads .

## ● Cautions when regrinding SMP drill heads

Note: SMF drill heads are not recommended to be reground due to little regrinding allowance.

### ① Clamping

- Assemble the drill head on the regrinding holder or shortest standard holder (3xD)
- Set-up the drill head in the machine : Total run-out must be less than 0.0008"

### ② Grinding the 1<sup>st</sup> clearance angle

- Set the drill for point angle (140°) and 1<sup>st</sup> clearance angle (8°)
- Keep the cutting edge in the horizontal plane

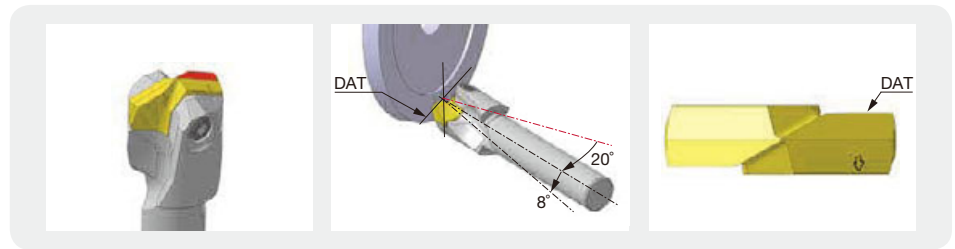

### ③ Grinding the 2<sup>nd</sup> clearance angle

- Set the drill for 2<sup>nd</sup> clearance angle (15°)

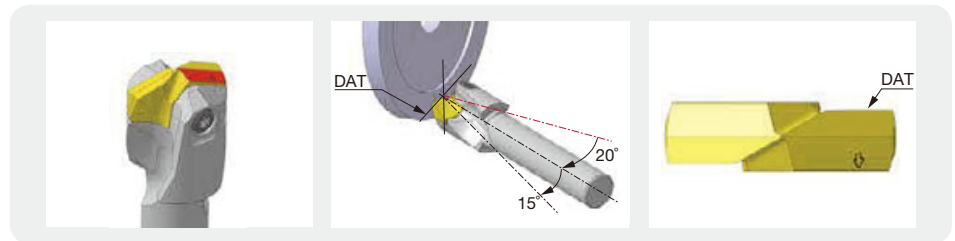

### ④ Grinding the chisel (Thinning)

- Set the drill for thinning angle (35°) with reference to drill axis and angle (30°) with reference to radial axis
- Keep the chisel thickness (0.006" - 0.008") and the thinning point must be over the center line

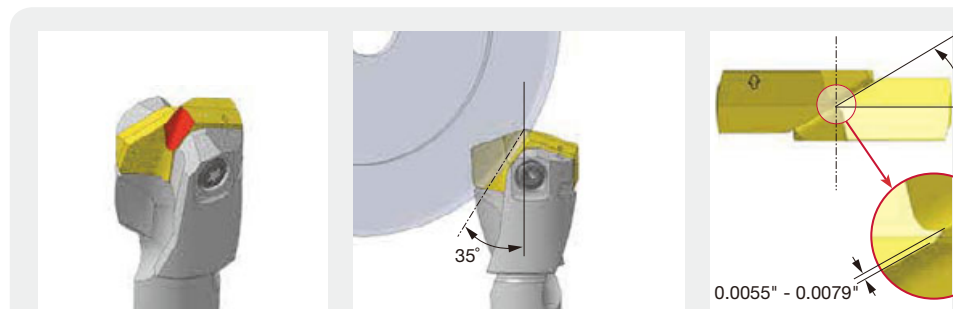

### ⑤ Edge preparation (Honing)

- Cutting edges should be honed by sand or brush (0.0016" - 0.0024")
- Nega-land by diamond hand lapper is also available
- The width of honing must be uniform with good surface finish

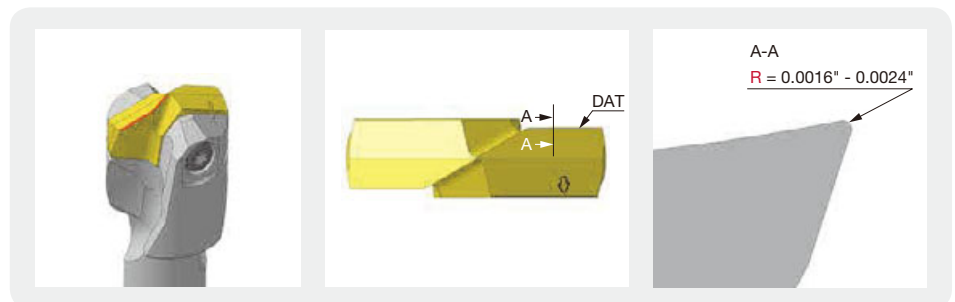

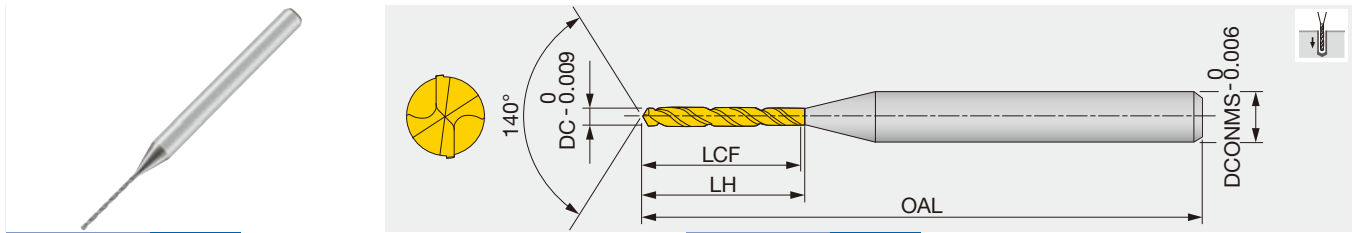

Metric	DC	Coated		DCONMS	LCF	LH	OAL	Metric	DC	Coated		DCONMS	LCF	LH	OAL
		YH170	YH180							YH170	YH180				
DSM0010G10	0.1	●		3	1.15	1.4	38	DSM0100G10	1	●		3	11.5	12.1	38
DSM0011G10	0.11	●		3	1.25	1.5	38	DSM0108G05	1.08	●		3	8	8.6	38
DSM0012G10	0.12	●		3	1.35	1.6	38	DSM0110G05	1.1	●		3	8	8.6	38
DSM0013G10	0.13	●		3	1.55	1.8	38	DSM0120G05	1.2	●		3	8.9	9.5	38
DSM0014G10	0.14	●		3	1.65	1.9	38	DSM0130G05	1.3	●		3	9.7	10.3	38
DSM0015G10	0.15	●		3	1.75	2	38	DSM0140G05	1.4	●		3	10.5	11.1	38
DSM0016G10	0.16	●		3	1.85	2.1	38	DSM0145G05	1.45	●		3	11.3	11.9	38
DSM0017G10	0.17	●		3	1.95	2.2	38	DSM0149G05	1.49	●		3	11.3	11.9	38
DSM0018G10	0.18	●		3	2.15	2.4	38	DSM0150G05	1.5	●		3	11.3	11.9	38
DSM0019G10	0.19	●		3	2.25	2.5	38	DSM0153G05	1.53	●		3	12.1	12.7	45
DSM0020G10	0.2	●		3	2.35	2.6	38	DSM0155G05	1.55	●		3	12.1	12.7	45
DSM0021G10	0.21	●		3	2.45	2.7	38	DSM0160G05	1.6	●		3	12.1	12.7	45
DSM0022G10	0.22	●		3	2.55	2.8	38	DSM0165G05	1.65	●		3	12.9	13.6	45
DSM0023G10	0.23	●		3	2.75	3	38	DSM0170G05	1.7	●		3	12.9	13.6	45
DSM0024G10	0.24	●		3	2.85	3.1	38	DSM0180G05	1.8	●		3	13.7	14.3	45
DSM0025G10	0.25	●		3	3	3.3	38	DSM0182G05	1.82	●		3	14.5	15.1	45
DSM0026G10	0.26	●		3	3.1	3.4	38	DSM0185G05	1.85	●		3	14.5	15.1	45
DSM0027G10	0.27	●		3	3.2	3.5	38	DSM0190G05	1.9	●		3	14.5	15.1	45
DSM0028G10	0.28	●		3	3.4	3.7	38	DSM0195G05	1.95	●		3	15.3	15.9	45
DSM0029G10	0.29	●		3	3.5	3.8	38	DSM0200G05	2		●	3	15.3	15.9	45
DSM0030G10	0.3	●		3	3.9	4.2	38	DSM0203G05	2.03		●	3	16.1	16.7	45
DSM0031G15	0.31	●		3	5.6	5.9	38	DSM0205G05	2.05		●	3	16.1	16.7	45
DSM0032G15	0.32	●		3	5.6	5.9	38	DSM0210G05	2.1		●	3	16.1	16.7	45
DSM0033G15	0.33	●		3	5.6	5.9	38	DSM0220G05	2.2		●	3	16.9	17.5	45
DSM0034G15	0.34	●		3	5.6	5.9	38	DSM0230G05	2.3		●	3	17.7	18.3	45
DSM0035G15	0.35	●		3	5.6	5.9	38	DSM0240G05	2.4		●	3	18.5	19.1	55
DSM0036G15	0.36	●		3	6.5	6.8	38	DSM0250G05	2.5		●	3	19.3	19.9	55
DSM0037G15	0.37	●		3	6.5	6.8	38	DSM0254G05	2.54		●	3	20.1	20.7	55
DSM0038G15	0.38	●		3	6.5	6.8	38	DSM0255G05	2.55		●	3	20.1	20.7	55
DSM0039G15	0.39	●		3	6.5	6.8	38	DSM0256G05	2.56		●	3	20.1	20.7	55
DSM0040G15	0.4	●		3	6.5	6.8	38	DSM0257G05	2.57		●	3	20.1	20.7	55
DSM0041G15	0.41	●		3	7.4	7.7	38	DSM0260G05	2.6		●	3	20.1	20.7	55
DSM0042G15	0.42	●		3	7.4	7.7	38	DSM0265G05	2.65		●	3	20.9	21.5	55
DSM0043G15	0.43	●		3	7.4	7.7	38	DSM0270G05	2.7		●	3	20.9	21.5	55
DSM0044G15	0.44	●		3	7.4	7.7	38	DSM0280G05	2.8		●	3	21.7	22.3	55
DSM0045G15	0.45	●		3	7.4	7.7	38	DSM0290G05	2.9		●	3	22.5	23.1	55
DSM0046G15	0.46	●		3	8.1	8.7	38	DSM0295G05	2.95		●	3	23.3	23.9	55
DSM0047G15	0.47	●		3	8.1	8.7	38	DSM0296G05	2.96		●	3	23.3	23.9	55
DSM0048G15	0.48	●		3	8.1	8.7	38	DSM0300G05	3		●	3	23.3	23.9	55
DSM0049G15	0.49	●		3	8.1	8.7	38								
DSM0050G15	0.5	●		3	8.1	8.7	38								
DSM0053G10	0.53	●		3	6.6	7.2	38								
DSM0055G10	0.55	●		3	6.6	7.2	38								
DSM0060G10	0.6	●		3	7.3	7.9	38								
DSM0061G10	0.61	●		3	7.9	8.5	38								
DSM0065G10	0.65	●		3	7.9	8.5	38								
DSM0070G10	0.7	●		3	8.6	9.2	38								
DSM0075G10	0.75	●		3	9.2	9.8	38								
DSM0080G10	0.8	●		3	9.9	10.5	38								
DSM0088G10	0.88	●		3	9.9	10.5	38								
DSM0090G10	0.9	●		3	9.9	10.5	38								
DSM0097G10	0.97	●		3	11	11.6	38								

● : Line up

## STANDARD CUTTING CONDITIONS

ISO	Workpiece material	Hardness	Cutting speed: Vc (sfm)			Feed: f (ipr)				
			ø0.004" ~ ø0.012"	ø0.012" ~ ø0.020"	ø0.020" ~ ø0.118"	ø0.004" ~ ø0.012"	ø0.012" ~ ø0.020"	ø0.020" ~ ø0.039"	ø0.039" ~ ø0.079"	ø0.079" ~ ø0.118"
<b>P</b>	Carbon steels, Alloy steels	- 300 HB	16 - 66	49 - 98	82 - 197	0.00004 - 0.00016	0.00008 - 0.0004	0.00020 - 0.0020	0.0012 - 0.0035	0.0020 - 0.004
<b>M</b>	Stainless steels	- 200 HB	7 - 39	20 - 59	33 - 66	0.00002 - 0.00016	0.00008 - 0.00031	0.00020 - 0.0012	0.0004 - 0.0016	0.0008 - 0.0020
<b>K</b>	Gray cast irons	150 - 250 HB	16 - 49	33 - 82	66 - 164	0.00002 - 0.00016	0.00008 - 0.0005	0.00020 - 0.0012	0.0004 - 0.0024	0.0012 - 0.005
	Ductile cast irons	150 - 250 HB	16 - 49	33 - 82	66 - 164	0.00004 - 0.00012	0.00008 - 0.0004	0.00020 - 0.0008	0.0004 - 0.0020	0.0012 - 0.004
<b>N</b>	Aluminum alloys	-	33 - 66	33 - 98	66 - 164	0.00004 - 0.0004	0.00020 - 0.0012	0.0004 - 0.0020	0.0016 - 0.006	0.0024 - 0.008
	Copper / Brass	-	33 - 66	33 - 98	66 - 164	0.00004 - 0.0004	0.00020 - 0.0012	0.0004 - 0.0020	0.0016 - 0.006	0.0024 - 0.008
<b>S</b>	Heat-resistant alloys	- 40 HRC	7 - 20	16 - 33	26 - 66	0.00002 - 0.00012	0.00008 - 0.00016	0.00008 - 0.00016	0.00008 - 0.00016	※
<b>H</b>	High hardened steels	- 50 HRC	13 - 26	20 - 33	20 - 52	0.00002 - 0.00008	0.00004 - 0.00020	0.00020 - 0.0008	0.0004 - 0.0012	0.0008 - 0.0024

※ Not recommended

Notes: • When the drilling depth is deeper than L/D = 5, use drill pecking every 10 to 50% of the drill diameter.

- The above cutting conditions are applied to when a water soluble cutting fluid is used. For drilling a hole smaller than ø0.3 mm, use of a starting drill is recommended.
- When setting the drill, the drill run out should be within 0.002 mm on the taper. (Especially for the drill diameter smaller than ø0.5 mm)

## SOLIDDRILL DSM-CP

Centering drill for DSM drill

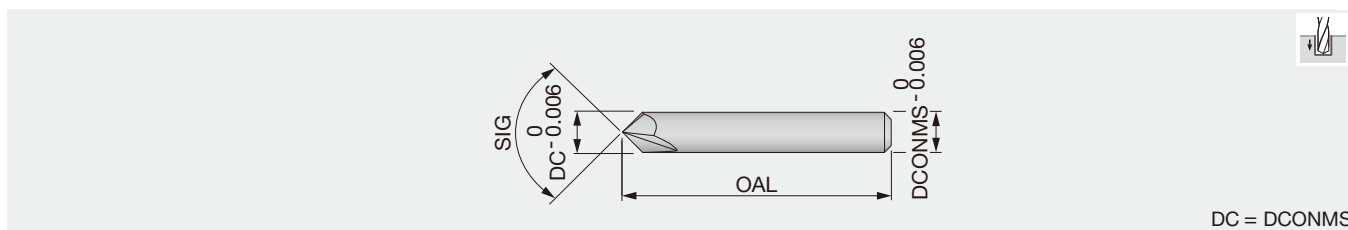

Metric	DC	YH170	DCONMS	OAL	SIG
DSM-CP90	3	●	3	38.1	90°
DSM-CP140	3	●	3	38.1	140°

● : Line up

## STANDARD CUTTING CONDITIONS

ISO	Workpiece material	Hardness	Cutting speed: Vc (sfm)	Feed: f (ipr)	
				DSM-CP90	DSM-CP140
<b>P</b>	Carbon, Mild and Alloy steels	- 300 HB	98 - 262	0.0004 - 0.0024	0.0012 - 0.0031
<b>M</b>	Stainless steels	- 200 HB	49 - 131	0.0004 - 0.0012	0.0008 - 0.0024
<b>K</b>	Gray and ductile cast irons	150 - 250 HB	98 - 262	0.0008 - 0.0024	0.0020 - 0.0039
<b>N</b>	Aluminum alloys	-	197 - 394	0.0008 - 0.0039	0.0020 - 0.0059
<b>H</b>	High hardened steels	- 45 HRC	33 - 131	※	0.0004 - 0.002

※ Not recommended

Notes: • For hard materials and stainless steels which have work-hardening nature, DSM-CP140 is recommended.

- Above cutting conditions are of using a water-soluble cutting fluid. When using a water-insoluble type, set the lower side of cutting conditions.

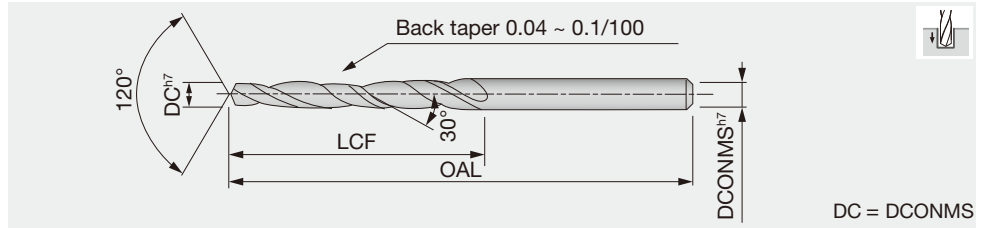

Metric	DC	UM	LCF	OAL	Metric	DC	UM	LCF	OAL
CDS-010	1	●	10	38	CDS-033	3.3	●	27	50
CDS-015	1.5	●	10	38	CDS-040	4	●	30	55
CDS-016	1.6	●	22	45	CDS-042	4.2	●	34	60
CDS-019	1.9	●	22	45	CDS-045	4.5	●	34	60
CDS-020	2	●	22	45	CDS-050	5	●	34	60
CDS-021	2.1	●	22	45	CDS-060	6	●	40	70
CDS-022	2.2	●	22	45	CDS-070	7	●	46	80
CDS-023	2.3	●	22	45	CDS-080	8	●	50	85
CDS-025	2.5	●	22	45	CDS-085	8.5	●	53	85
CDS-029	2.9	●	25	45	CDS-090	9	●	53	85
CDS-030	3	●	25	45					

DC = DCONMS

● : Line up

DC	Tolerance h7 (mm)
1 < DC ≤ 3	0 ~ -0.010
3 < DC ≤ 6	0 ~ -0.012
6 < DC ≤ 9	0 ~ -0.015

### CAUTIONARY NOTES

- To prevent edge chipping, hone cutting edges as follows:  
 Honing width: 0.02 ~ 0.05 mm  
 Honing angle: -20° to -30°.  
 Chipping is likely to occur on edges when drilling hard materials, a larger honing width is recommended.
- When drilling into an inclined surface, special care should be taken to prevent drill breakage.  
 Use of drill bushing is recommended for such cases.

### REGRINDING

- Carry out regrinding when corner wear reaches the margin width.
- Avoid using silicon carbide grinding wheels or hand grinding whenever possible.  
 Replace mesh with grit wheel of 200 to 400 mesh.
- Apply web thinning for the drill above ø6 mm. S-type thinning shown in figure at right is recommended.  
 Preferable thinning width (W1) is about 1/2 to 1/3 of web thickness (W).

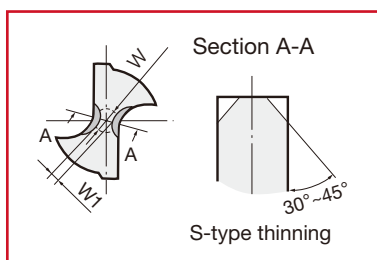

### STANDARD CUTTING CONDITIONS

See more information

e-catalog



# SOLIDDRILL

## DSW-DE3

Solid drill/D = 3, DIN shank, without coolant hole

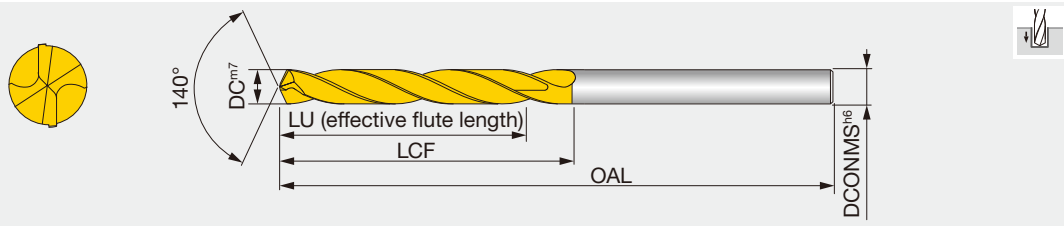

Metric	DC	AH725	DCONMS	LU	LCF	OAL	Metric	DC	AH725	DCONMS	LU	LCF	OAL
DSW030-014-06DE3	3	●	6	14	20	62	DSW076-029-08DE3	7.6	●	8	29	41	79
DSW031-014-06DE3	3.1	●	6	14	20	62	DSW077-029-08DE3	7.7	●	8	29	41	79
DSW032-014-06DE3	3.2	●	6	14	20	62	DSW078-029-08DE3	7.8	●	8	29	41	79
DSW033-014-06DE3	3.3	●	6	14	20	62	DSW079-029-08DE3	7.9	●	8	29	41	79
DSW034-014-06DE3	3.4	●	6	14	20	62	DSW080-029-08DE3	8	●	8	29	41	79
DSW035-014-06DE3	3.5	●	6	14	20	62	DSW081-035-10DE3	8.1	●	10	35	47	89
DSW036-014-06DE3	3.6	●	6	14	20	62	DSW082-035-10DE3	8.2	●	10	35	47	89
DSW037-014-06DE3	3.7	●	6	14	20	62	DSW083-035-10DE3	8.3	●	10	35	47	89
DSW038-017-06DE3	3.8	●	6	17	24	66	DSW084-035-10DE3	8.4	●	10	35	47	89
DSW039-017-06DE3	3.9	●	6	17	24	66	DSW085-035-10DE3	8.5	●	10	35	47	89
DSW040-017-06DE3	4	●	6	17	24	66	DSW086-035-10DE3	8.6	●	10	35	47	89
DSW041-017-06DE3	4.1	●	6	17	24	66	DSW087-035-10DE3	8.7	●	10	35	47	89
DSW042-017-06DE3	4.2	●	6	17	24	66	DSW088-035-10DE3	8.8	●	10	35	47	89
DSW043-017-06DE3	4.3	●	6	17	24	66	DSW089-035-10DE3	8.9	●	10	35	47	89
DSW044-017-06DE3	4.4	●	6	17	24	66	DSW090-035-10DE3	9	●	10	35	47	89
DSW045-017-06DE3	4.5	●	6	17	24	66	DSW091-035-10DE3	9.1	●	10	35	47	89
DSW046-017-06DE3	4.6	●	6	17	24	66	DSW092-035-10DE3	9.2	●	10	35	47	89
DSW047-017-06DE3	4.7	●	6	17	24	66	DSW093-035-10DE3	9.3	●	10	35	47	89
DSW048-020-06DE3	4.8	●	6	20	28	66	DSW094-035-10DE3	9.4	●	10	35	47	89
DSW049-020-06DE3	4.9	●	6	20	28	66	DSW095-035-10DE3	9.5	●	10	35	47	89
DSW050-020-06DE3	5	●	6	20	28	66	DSW096-035-10DE3	9.6	●	10	35	47	89
DSW051-020-06DE3	5.1	●	6	20	28	66	DSW097-035-10DE3	9.7	●	10	35	47	89
DSW052-020-06DE3	5.2	●	6	20	28	66	DSW098-035-10DE3	9.8	●	10	35	47	89
DSW053-020-06DE3	5.3	●	6	20	28	66	DSW099-035-10DE3	9.9	●	10	35	47	89
DSW054-020-06DE3	5.4	●	6	20	28	66	DSW100-035-10DE3	10	●	10	35	47	89
DSW055-020-06DE3	5.5	●	6	20	28	66	DSW101-040-12DE3	10.1	●	12	40	55	102
DSW056-020-06DE3	5.6	●	6	20	28	66	DSW102-040-12DE3	10.2	●	12	40	55	102
DSW057-020-06DE3	5.7	●	6	20	28	66	DSW103-040-12DE3	10.3	●	12	40	55	102
DSW058-020-06DE3	5.8	●	6	20	28	66	DSW104-040-12DE3	10.4	●	12	40	55	102
DSW059-020-06DE3	5.9	●	6	20	28	66	DSW105-040-12DE3	10.5	●	12	40	55	102
DSW060-020-06DE3	6	●	6	20	28	66	DSW106-040-12DE3	10.6	●	12	40	55	102
DSW061-024-08DE3	6.1	●	8	24	34	79	DSW107-040-12DE3	10.7	●	12	40	55	102
DSW062-024-08DE3	6.2	●	8	24	34	79	DSW108-040-12DE3	10.8	●	12	40	55	102
DSW063-024-08DE3	6.3	●	8	24	34	79	DSW109-040-12DE3	10.9	●	12	40	55	102
DSW064-024-08DE3	6.4	●	8	24	34	79	DSW110-040-12DE3	11	●	12	40	55	102
DSW065-024-08DE3	6.5	●	8	24	34	79	DSW111-040-12DE3	11.1	●	12	40	55	102
DSW066-024-08DE3	6.6	●	8	24	34	79	DSW112-040-12DE3	11.2	●	12	40	55	102
DSW067-024-08DE3	6.7	●	8	24	34	79	DSW113-040-12DE3	11.3	●	12	40	55	102
DSW068-024-08DE3	6.8	●	8	24	34	79	DSW114-040-12DE3	11.4	●	12	40	55	102
DSW069-024-08DE3	6.9	●	8	24	34	79	DSW115-040-12DE3	11.5	●	12	40	55	102
DSW070-024-08DE3	7	●	8	24	34	79	DSW116-040-12DE3	11.6	●	12	40	55	102
DSW071-029-08DE3	7.1	●	8	29	41	79	DSW117-040-12DE3	11.7	●	12	40	55	102
DSW072-029-08DE3	7.2	●	8	29	41	79	DSW118-040-12DE3	11.8	●	12	40	55	102
DSW073-029-08DE3	7.3	●	8	29	41	79	DSW119-040-12DE3	11.9	●	12	40	55	102
DSW074-029-08DE3	7.4	●	8	29	41	79	DSW120-040-12DE3	12	●	12	40	55	102
DSW075-029-08DE3	7.5	●	8	29	41	79							

● : Line up

### STANDARD CUTTING CONDITIONS

See more information

e-catalog





# DSW-DE5

Solid drill, L/D = 5, DIN shank, without coolant hole

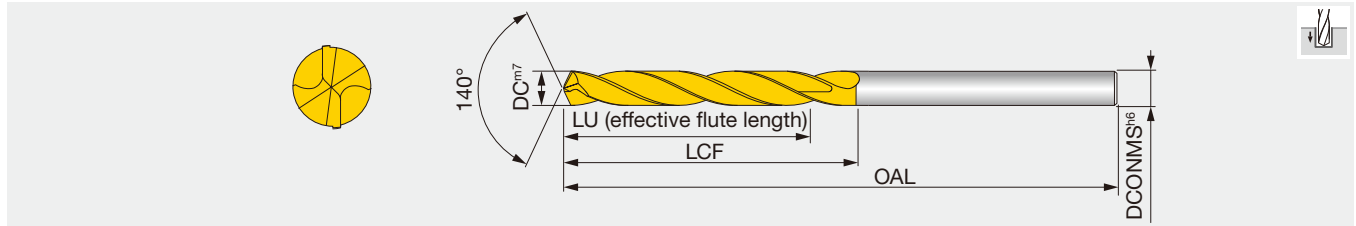

Metric	DC	AH725	DCONMS	LU	LCF	OAL	Metric	DC	AH725	DCONMS	LU	LCF	OAL
DSW030-023-06DE5	3	●	6	23	28	66	DSW076-043-08DE5	7.6	●	8	43	53	91
DSW031-023-06DE5	3.1	●	6	23	28	66	DSW077-043-08DE5	7.7	●	8	43	53	91
DSW032-023-06DE5	3.2	●	6	23	28	66	DSW078-043-08DE5	7.8	●	8	43	53	91
DSW033-023-06DE5	3.3	●	6	23	28	66	DSW079-043-08DE5	7.9	●	8	43	53	91
DSW034-023-06DE5	3.4	●	6	23	28	66	DSW080-043-08DE5	8	●	8	43	53	91
DSW035-023-06DE5	3.5	●	6	23	28	66	DSW081-049-10DE5	8.1	●	10	49	61	103
DSW036-023-06DE5	3.6	●	6	23	28	66	DSW082-049-10DE5	8.2	●	10	49	61	103
DSW037-023-06DE5	3.7	●	6	23	28	66	DSW083-049-10DE5	8.3	●	10	49	61	103
DSW038-029-06DE5	3.8	●	6	29	36	74	DSW084-049-10DE5	8.4	●	10	49	61	103
DSW039-029-06DE5	3.9	●	6	29	36	74	DSW085-049-10DE5	8.5	●	10	49	61	103
DSW040-029-06DE5	4	●	6	29	36	74	DSW086-049-10DE5	8.6	●	10	49	61	103
DSW041-029-06DE5	4.1	●	6	29	36	74	DSW087-049-10DE5	8.7	●	10	49	61	103
DSW042-029-06DE5	4.2	●	6	29	36	74	DSW088-049-10DE5	8.8	●	10	49	61	103
DSW043-029-06DE5	4.3	●	6	29	36	74	DSW089-049-10DE5	8.9	●	10	49	61	103
DSW044-029-06DE5	4.4	●	6	29	36	74	DSW090-049-10DE5	9	●	10	49	61	103
DSW045-029-06DE5	4.5	●	6	29	36	74	DSW091-049-10DE5	9.1	●	10	49	61	103
DSW046-029-06DE5	4.6	●	6	29	36	74	DSW092-049-10DE5	9.2	●	10	49	61	103
DSW047-029-06DE5	4.7	●	6	29	36	74	DSW093-049-10DE5	9.3	●	10	49	61	103
DSW048-035-06DE5	4.8	●	6	35	44	82	DSW094-049-10DE5	9.4	●	10	49	61	103
DSW049-035-06DE5	4.9	●	6	35	44	82	DSW095-049-10DE5	9.5	●	10	49	61	103
DSW050-035-06DE5	5	●	6	35	44	82	DSW096-049-10DE5	9.6	●	10	49	61	103
DSW051-035-06DE5	5.1	●	6	35	44	82	DSW097-049-10DE5	9.7	●	10	49	61	103
DSW052-035-06DE5	5.2	●	6	35	44	82	DSW098-049-10DE5	9.8	●	10	49	61	103
DSW053-035-06DE5	5.3	●	6	35	44	82	DSW099-049-10DE5	9.9	●	10	49	61	103
DSW054-035-06DE5	5.4	●	6	35	44	82	DSW100-049-10DE5	10	●	10	49	61	103
DSW055-035-06DE5	5.5	●	6	35	44	82	DSW101-056-12DE5	10.1	●	12	56	71	118
DSW056-035-06DE5	5.6	●	6	35	44	82	DSW102-056-12DE5	10.2	●	12	56	71	118
DSW057-035-06DE5	5.7	●	6	35	44	82	DSW103-056-12DE5	10.3	●	12	56	71	118
DSW058-035-06DE5	5.8	●	6	35	44	82	DSW104-056-12DE5	10.4	●	12	56	71	118
DSW059-035-06DE5	5.9	●	6	35	44	82	DSW105-056-12DE5	10.5	●	12	56	71	118
DSW060-035-06DE5	6	●	6	35	44	82	DSW106-056-12DE5	10.6	●	12	56	71	118
DSW061-043-08DE5	6.1	●	8	43	53	91	DSW107-056-12DE5	10.7	●	12	56	71	118
DSW062-043-08DE5	6.2	●	8	43	53	91	DSW108-056-12DE5	10.8	●	12	56	71	118
DSW063-043-08DE5	6.3	●	8	43	53	91	DSW109-056-12DE5	10.9	●	12	56	71	118
DSW064-043-08DE5	6.4	●	8	43	53	91	DSW110-056-12DE5	11	●	12	56	71	118
DSW065-043-08DE5	6.5	●	8	43	53	91	DSW111-056-12DE5	11.1	●	12	56	71	118
DSW066-043-08DE5	6.6	●	8	43	53	91	DSW112-056-12DE5	11.2	●	12	56	71	118
DSW067-043-08DE5	6.7	●	8	43	53	91	DSW113-056-12DE5	11.3	●	12	56	71	118
DSW068-043-08DE5	6.8	●	8	43	53	91	DSW114-056-12DE5	11.4	●	12	56	71	118
DSW069-043-08DE5	6.9	●	8	43	53	91	DSW115-056-12DE5	11.5	●	12	56	71	118
DSW070-043-08DE5	7	●	8	43	53	91	DSW116-056-12DE5	11.6	●	12	56	71	118
DSW071-043-08DE5	7.1	●	8	43	53	91	DSW117-056-12DE5	11.7	●	12	56	71	118
DSW072-043-08DE5	7.2	●	8	43	53	91	DSW118-056-12DE5	11.8	●	12	56	71	118
DSW073-043-08DE5	7.3	●	8	43	53	91	DSW119-056-12DE5	11.9	●	12	56	71	118
DSW074-043-08DE5	7.4	●	8	43	53	91	DSW120-056-12DE5	12	●	12	56	71	118
DSW075-043-08DE5	7.5	●	8	43	53	91							

● : Line up

## STANDARD CUTTING CONDITIONS

See more information

e-catalog



# SOLIDDRILL

## DSW-DI5

Solid drill, L/D = 5, DIN shank, with coolant hole

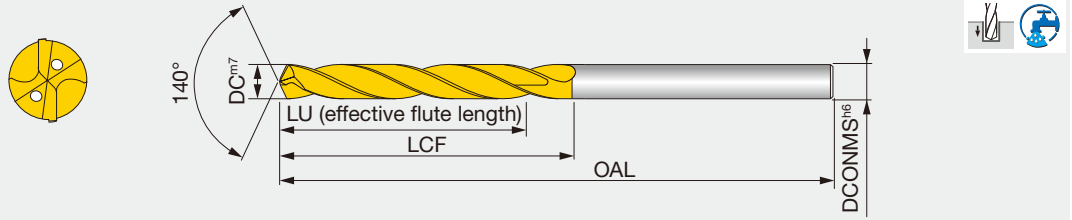

Metric	DC	AH725	DCONMS	LU	LCF	OAL	Metric	DC	AH725	DCONMS	LU	LCF	OAL
DSW030-023-06DI5	3	●	6	23	28	66	DSW076-043-08DI5	7.6	●	8	43	53	91
DSW031-023-06DI5	3.1	●	6	23	28	66	DSW077-043-08DI5	7.7	●	8	43	53	91
DSW032-023-06DI5	3.2	●	6	23	28	66	DSW078-043-08DI5	7.8	●	8	43	53	91
DSW033-023-06DI5	3.3	●	6	23	28	66	DSW079-043-08DI5	7.9	●	8	43	53	91
DSW034-023-06DI5	3.4	●	6	23	28	66	DSW080-043-08DI5	8	●	8	43	53	91
DSW035-023-06DI5	3.5	●	6	23	28	66	DSW081-049-10DI5	8.1	●	10	49	61	103
DSW036-023-06DI5	3.6	●	6	23	28	66	DSW082-049-10DI5	8.2	●	10	49	61	103
DSW037-023-06DI5	3.7	●	6	23	28	66	DSW083-049-10DI5	8.3	●	10	49	61	103
DSW038-029-06DI5	3.8	●	6	29	36	74	DSW084-049-10DI5	8.4	●	10	49	61	103
DSW039-029-06DI5	3.9	●	6	29	36	74	DSW085-049-10DI5	8.5	●	10	49	61	103
DSW040-029-06DI5	4	●	6	29	36	74	DSW086-049-10DI5	8.6	●	10	49	61	103
DSW041-029-06DI5	4.1	●	6	29	36	74	DSW087-049-10DI5	8.7	●	10	49	61	103
DSW042-029-06DI5	4.2	●	6	29	36	74	DSW088-049-10DI5	8.8	●	10	49	61	103
DSW043-029-06DI5	4.3	●	6	29	36	74	DSW089-049-10DI5	8.9	●	10	49	61	103
DSW044-029-06DI5	4.4	●	6	29	36	74	DSW090-049-10DI5	9	●	10	49	61	103
DSW045-029-06DI5	4.5	●	6	29	36	74	DSW091-049-10DI5	9.1	●	10	49	61	103
DSW046-029-06DI5	4.6	●	6	29	36	74	DSW092-049-10DI5	9.2	●	10	49	61	103
DSW047-029-06DI5	4.7	●	6	29	36	74	DSW093-049-10DI5	9.3	●	10	49	61	103
DSW048-035-06DI5	4.8	●	6	35	44	82	DSW094-049-10DI5	9.4	●	10	49	61	103
DSW049-035-06DI5	4.9	●	6	35	44	82	DSW095-049-10DI5	9.5	●	10	49	61	103
DSW050-035-06DI5	5	●	6	35	44	82	DSW096-049-10DI5	9.6	●	10	49	61	103
DSW051-035-06DI5	5.1	●	6	35	44	82	DSW097-049-10DI5	9.7	●	10	49	61	103
DSW052-035-06DI5	5.2	●	6	35	44	82	DSW098-049-10DI5	9.8	●	10	49	61	103
DSW053-035-06DI5	5.3	●	6	35	44	82	DSW099-049-10DI5	9.9	●	10	49	61	103
DSW054-035-06DI5	5.4	●	6	35	44	82	DSW100-049-10DI5	10	●	10	49	61	103
DSW055-035-06DI5	5.5	●	6	35	44	82	DSW101-056-12DI5	10.1	●	12	56	71	118
DSW056-035-06DI5	5.6	●	6	35	44	82	DSW102-056-12DI5	10.2	●	12	56	71	118
DSW057-035-06DI5	5.7	●	6	35	44	82	DSW103-056-12DI5	10.3	●	12	56	71	118
DSW058-035-06DI5	5.8	●	6	35	44	82	DSW104-056-12DI5	10.4	●	12	56	71	118
DSW059-035-06DI5	5.9	●	6	35	44	82	DSW105-056-12DI5	10.5	●	12	56	71	118
DSW060-035-06DI5	6	●	6	35	44	82	DSW106-056-12DI5	10.6	●	12	56	71	118
DSW061-043-08DI5	6.1	●	8	43	53	91	DSW107-056-12DI5	10.7	●	12	56	71	118
DSW062-043-08DI5	6.2	●	8	43	53	91	DSW108-056-12DI5	10.8	●	12	56	71	118
DSW063-043-08DI5	6.3	●	8	43	53	91	DSW109-056-12DI5	10.9	●	12	56	71	118
DSW064-043-08DI5	6.4	●	8	43	53	91	DSW110-056-12DI5	11	●	12	56	71	118
DSW065-043-08DI5	6.5	●	8	43	53	91	DSW111-056-12DI5	11.1	●	12	56	71	118
DSW066-043-08DI5	6.6	●	8	43	53	91	DSW112-056-12DI5	11.2	●	12	56	71	118
DSW067-043-08DI5	6.7	●	8	43	53	91	DSW113-056-12DI5	11.3	●	12	56	71	118
DSW068-043-08DI5	6.8	●	8	43	53	91	DSW114-056-12DI5	11.4	●	12	56	71	118
DSW069-043-08DI5	6.9	●	8	43	53	91	DSW115-056-12DI5	11.5	●	12	56	71	118
DSW070-043-08DI5	7	●	8	43	53	91	DSW116-056-12DI5	11.6	●	12	56	71	118
DSW071-043-08DI5	7.1	●	8	43	53	91	DSW117-056-12DI5	11.7	●	12	56	71	118
DSW072-043-08DI5	7.2	●	8	43	53	91	DSW118-056-12DI5	11.8	●	12	56	71	118
DSW073-043-08DI5	7.3	●	8	43	53	91	DSW119-056-12DI5	11.9	●	12	56	71	118
DSW074-043-08DI5	7.4	●	8	43	53	91	DSW120-056-12DI5	12	●	12	56	71	118
DSW075-043-08DI5	7.5	●	8	43	53	91							

● : Line up

## STANDARD CUTTING CONDITIONS

See more information

e-catalog





# DSW-DI8

Solid drill, L/D = 8, DIN shank, with coolant hole

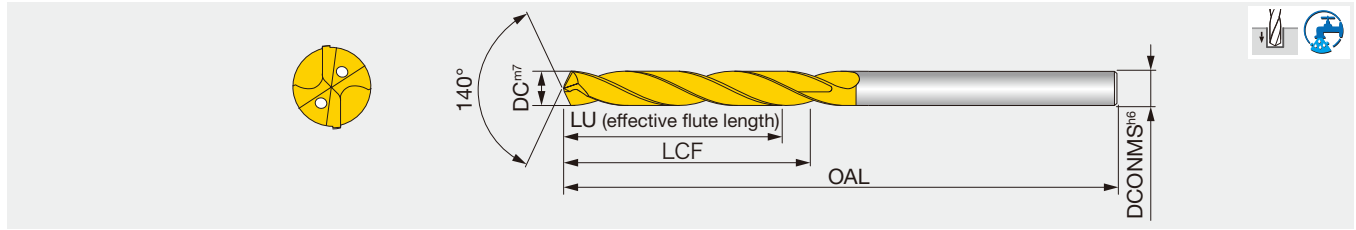

Metric	DC	AH725	DCONMS	LU	LCF	OAL	Metric	DC	AH725	DCONMS	LU	LCF	OAL
DSW030-029-06DI8	3	●	6	29	34	72	DSW066-064-08DI8	6.6	●	8	64	76	114
DSW031-029-06DI8	3.1	●	6	29	34	72	DSW067-064-08DI8	6.7	●	8	64	76	114
DSW032-029-06DI8	3.2	●	6	29	34	72	DSW068-064-08DI8	6.8	●	8	64	76	114
DSW033-029-06DI8	3.3	●	6	29	34	72	DSW069-064-08DI8	6.9	●	8	64	76	114
DSW034-029-06DI8	3.4	●	6	29	34	72	DSW070-064-08DI8	7	●	8	64	76	114
DSW035-029-06DI8	3.5	●	6	29	34	72	DSW071-064-08DI8	7.1	●	8	64	76	114
DSW036-029-06DI8	3.6	●	6	29	34	72	DSW072-064-08DI8	7.2	●	8	64	76	114
DSW037-029-06DI8	3.7	●	6	29	34	72	DSW073-064-08DI8	7.3	●	8	64	76	114
DSW038-036-06DI8	3.8	●	6	36	43	81	DSW074-064-08DI8	7.4	●	8	64	76	114
DSW039-036-06DI8	3.9	●	6	36	43	81	DSW075-064-08DI8	7.5	●	8	64	76	114
DSW040-036-06DI8	4	●	6	36	43	81	DSW076-064-08DI8	7.6	●	8	64	76	114
DSW041-036-06DI8	4.1	●	6	36	43	81	DSW077-064-08DI8	7.7	●	8	64	76	114
DSW042-036-06DI8	4.2	●	6	36	43	81	DSW078-064-08DI8	7.8	●	8	64	76	114
DSW043-036-06DI8	4.3	●	6	36	43	81	DSW079-064-08DI8	7.9	●	8	64	76	114
DSW044-036-06DI8	4.4	●	6	36	43	81	DSW080-064-08DI8	8	●	8	64	76	114
DSW045-036-06DI8	4.5	●	6	36	43	81	DSW081-080-10DI8	8.1	●	10	80	95	142
DSW046-036-06DI8	4.6	●	6	36	43	81	DSW082-080-10DI8	8.2	●	10	80	95	142
DSW047-036-06DI8	4.7	●	6	36	43	81	DSW083-080-10DI8	8.3	●	10	80	95	142
DSW048-048-06DI8	4.8	●	6	48	57	95	DSW084-080-10DI8	8.4	●	10	80	95	142
DSW049-048-06DI8	4.9	●	6	48	57	95	DSW085-080-10DI8	8.5	●	10	80	95	142
DSW050-048-06DI8	5	●	6	48	57	95	DSW086-080-10DI8	8.6	●	10	80	95	142
DSW051-048-06DI8	5.1	●	6	48	57	95	DSW087-080-10DI8	8.7	●	10	80	95	142
DSW052-048-06DI8	5.2	●	6	48	57	95	DSW088-080-10DI8	8.8	●	10	80	95	142
DSW053-048-06DI8	5.3	●	6	48	57	95	DSW089-080-10DI8	8.9	●	10	80	95	142
DSW054-048-06DI8	5.4	●	6	48	57	95	DSW090-080-10DI8	9	●	10	80	95	142
DSW055-048-06DI8	5.5	●	6	48	57	95	DSW091-080-10DI8	9.1	●	10	80	95	142
DSW056-048-06DI8	5.6	●	6	48	57	95	DSW092-080-10DI8	9.2	●	10	80	95	142
DSW057-048-06DI8	5.7	●	6	48	57	95	DSW093-080-10DI8	9.3	●	10	80	95	142
DSW058-048-06DI8	5.8	●	6	48	57	95	DSW094-080-10DI8	9.4	●	10	80	95	142
DSW059-048-06DI8	5.9	●	6	48	57	95	DSW095-080-10DI8	9.5	●	10	80	95	142
DSW060-048-06DI8	6	●	6	48	57	95	DSW096-080-10DI8	9.6	●	10	80	95	142
DSW061-064-08DI8	6.1	●	8	64	76	114	DSW097-080-10DI8	9.7	●	10	80	95	142
DSW062-064-08DI8	6.2	●	8	64	76	114	DSW098-080-10DI8	9.8	●	10	80	95	142
DSW063-064-08DI8	6.3	●	8	64	76	114	DSW099-080-10DI8	9.9	●	10	80	95	142
DSW064-064-08DI8	6.4	●	8	64	76	114	DSW100-080-10DI8	10	●	10	80	95	142
DSW065-064-08DI8	6.5	●	8	64	76	114							

● : Line up

## STANDARD CUTTING CONDITIONS

See more information

e-catalog



Grade  
Insert  
Ext. Toolholder  
Int. Toolholder  
Threading  
Grooving  
Miniature tool  
Milling cutter  
Endmill  
Drilling tool  
Tooling System  
User's Guide  
Index

A  
B  
C  
D  
E  
F  
G  
H  
I  
J  
K  
L  
M

### Recommended coolant pressure and volume for internal coolant supply:

The following graph is a reference guide for pressure and volume. Values should be adjusted according to work material and actual chip evacuation.

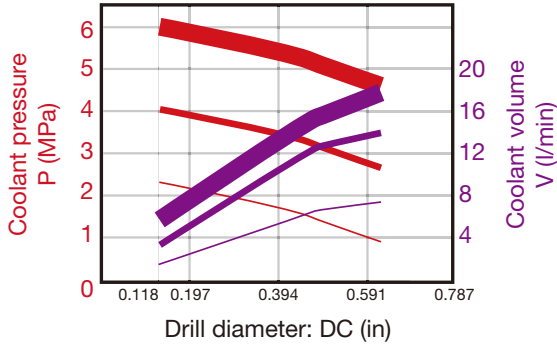

- █ : Ideal pressure
- █ : Enough pressure
- █ : Minimum pressure
- █ : Ideal volume
- █ : Enough volume
- █ : Minimum volume

### Reference for required spindle power:

The required spindle power may vary depending on the type of work material or hardness. A spindle with sufficient power should be used when referring to the below graph.

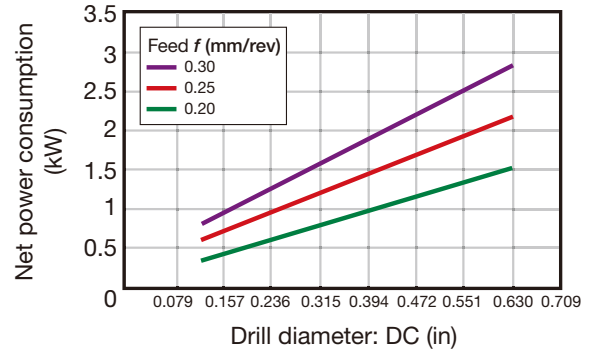

Work material : Alloy steel (4340)  
 Cutting speed :  $V_c = 328$  sfm

# SOLIDDRILL

## DSXU-F03, F05

Solid drill, L/D = 3, 5 with coolant hole

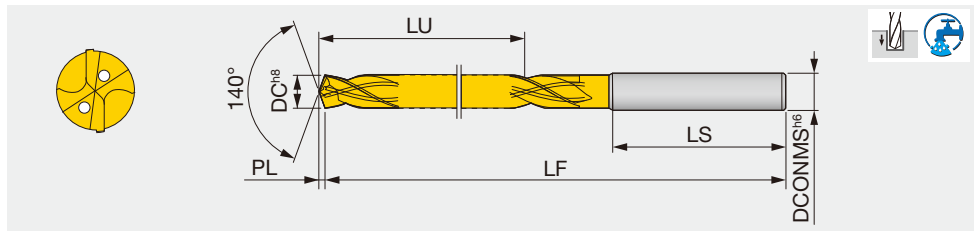

### L/D = 3

Inch	DC	AH180	DCONMS	LU	LS	LF	PL
DSXU2031F03	13/64	●	0.203	1.137	2.050	3.230	0.037
DSXU2344F03	15/64	●	0.234	1.223	2.050	3.230	0.043
DSXU2500F03	1/4	●	0.25	1.345	2.090	3.390	0.045
DSXU2656F03	17/64	●	0.266	1.428	2.090	3.460	0.048
DSXU2813F03	9/32	●	0.281	1.551	2.130	3.620	0.051
DSXU3125F03	5/16	●	0.313	1.627	2.130	3.700	0.057
DSXU3438F03	11/32	●	0.344	1.833	2.170	3.940	0.063
DSXU3750F03	3/8	●	0.375	2.038	2.200	4.170	0.068
DSXU3906F03	25/64	●	0.391	2.041	2.200	4.170	0.071
DSXU4063F03	13/32	●	0.406	2.164	2.400	4.570	0.074
DSXU4219F03	27/64	●	0.422	2.247	2.400	4.570	0.077
DSXU4375F03	7/16	●	0.438	2.360	2.440	4.800	0.080
DSXU4531F03	29/64	●	0.453	2.442	2.440	4.800	0.082
DSXU4688F03	15/32	●	0.469	2.445	2.440	4.800	0.085
DSXU4844F03	31/64	●	0.484	2.648	2.480	5.040	0.088
DSXU5000F03	1/2	●	0.500	2.651	2.480	5.040	0.091
DSXU5156F03	33/64	●	0.516	2.854	2.520	5.280	0.094
DSXU5313F03	17/32	●	0.531	2.857	2.520	5.280	0.097
DSXU5469F03	35/64	●	0.547	2.86	2.520	5.280	0.100
DSXU5625F03	9/16	●	0.563	3.052	2.560	5.510	0.102
DSXU5938F03	19/32	●	0.594	3.258	2.600	5.750	0.108
DSXU6250F03	5/8	●	0.625	3.264	2.600	5.750	0.114
DSXU6562F03	21/32	●	0.656	3.469	2.640	5.980	0.119
DSXU6875F03	11/16	●	0.688	3.665	2.680	6.220	0.125

### L/D = 5

Inch	DC	AH180	DCONMS	LU	LS	LF	PL
DSXU2031F05	13/64	●	0.203	1.767	2.050	3.780	0.037
DSXU2188F05	7/32	●	0.219	1.93	2.050	3.940	0.040
DSXU2344F05	15/64	●	0.234	1.933	2.050	3.940	0.043
DSXU2500F05	1/4	●	0.25	2.095	2.090	4.130	0.045
DSXU2656F05	17/64	●	0.266	2.248	2.090	4.290	0.048
DSXU2813F05	9/32	●	0.281	2.411	2.130	4.490	0.051
DSXU2969F05	19/64	●	0.297	2.574	2.130	4.650	0.054
DSXU3125F05	5/16	●	0.313	2.577	2.130	4.650	0.057
DSXU3281F05	21/64	●	0.328	2.74	2.170	5.000	0.060
DSXU3438F05	11/32	●	0.344	2.893	2.170	5.000	0.063
DSXU3594F05	23/64	●	0.359	3.055	2.200	5.350	0.065
DSXU3750F05	3/8	●	0.375	3.218	2.200	5.350	0.068
DSXU3906F05	25/64	●	0.391	3.221	2.200	5.350	0.071
DSXU4063F05	13/32	●	0.406	3.384	2.400	5.870	0.074
DSXU4219F05	27/64	●	0.422	3.537	2.400	5.870	0.077
DSXU4375F05	7/16	●	0.438	3.700	2.440	6.220	0.080
DSXU4531F05	29/64	●	0.453	3.862	2.440	6.220	0.082
DSXU4844F05	31/64	●	0.484	4.178	2.480	6.570	0.088
DSXU5000F05	1/2	●	0.500	4.181	2.480	6.570	0.091
DSXU5156F05	33/64	●	0.516	4.504	2.520	6.930	0.094
DSXU5313F05	17/32	●	0.531	4.507	2.520	6.930	0.097
DSXU5625F05	9/16	●	0.563	4.822	2.560	7.280	0.102
DSXU6250F05	5/8	●	0.625	5.154	2.600	7.640	0.114
DSXU6562F05	21/32	●	0.656	5.469	2.640	7.990	0.119

● : Line up

## STANDARD CUTTING CONDITIONS

See more information

e-catalog



Grade  
Insert  
Ext. Toolholder  
Int. Toolholder  
Threading  
Grooving  
Miniature tool  
Milling cutter  
Endmill  
Drilling tool  
Tooling System  
User's Guide  
Index



# SOLIDDRILL

## DSX-F03

Solid drill, L/D = 3, with coolant hole

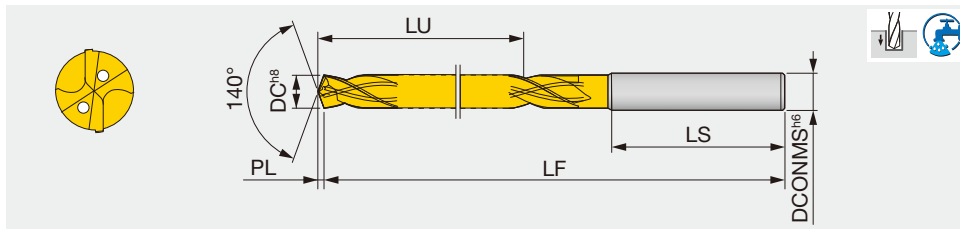

Metric	DC	AH180	DCONMS	LU	LS	LF	PL	Metric	DC	AH180	DCONMS	LU	LS	LF	PL
DSX0300F03	3	●	3	9.6	48	68	0.55	DSX0740F03	7.4	●	8	23.6	54	92	1.35
DSX0310F03	3.1	●	4	9.9	48	71	0.56	DSX0750F03	7.5	●	8	23.9	54	92	1.36
DSX0320F03	3.2	●	4	10.2	48	71	0.58	DSX0760F03	7.6	●	8	24.2	54	94	1.38
DSX0330F03	3.3	●	4	10.5	48	71	0.6	DSX0770F03	7.7	●	8	24.5	54	94	1.4
DSX0340F03	3.4	●	4	10.8	48	71	0.62	DSX0780F03	7.8	●	8	24.8	54	94	1.42
DSX0350F03	3.5	●	4	11.1	48	71	0.64	DSX0790F03	7.9	●	8	25.1	54	94	1.44
DSX0360F03	3.6	●	4	11.5	48	73	0.66	DSX0800F03	8	●	8	25.5	54	94	1.46
DSX0370F03	3.7	●	4	11.8	48	73	0.67	DSX0810F03	8.1	●	9	25.8	55	100	1.47
DSX0380F03	3.8	●	4	12.1	48	73	0.69	DSX0820F03	8.2	●	9	26.1	55	100	1.49
DSX0390F03	3.9	●	4	12.4	48	73	0.71	DSX0830F03	8.3	●	9	26.4	55	100	1.51
DSX0400F03	4	●	4	12.7	48	73	0.73	DSX0840F03	8.4	●	9	26.7	55	100	1.53
DSX0410F03	4.1	●	5	13.1	50	78	0.75	DSX0850F03	8.5	●	9	27.1	55	100	1.55
DSX0420F03	4.2	●	5	13.4	50	78	0.76	DSX0860F03	8.6	●	9	27.4	55	100	1.57
DSX0430F03	4.3	●	5	13.7	50	78	0.78	DSX0870F03	8.7	●	9	27.7	55	100	1.58
DSX0440F03	4.4	●	5	14	50	78	0.8	DSX0880F03	8.8	●	9	28	55	100	1.6
DSX0450F03	4.5	●	5	14.3	50	78	0.82	DSX0890F03	8.9	●	9	28.3	55	100	1.62
DSX0460F03	4.6	●	5	14.6	50	80	0.84	DSX0900F03	9	●	9	28.6	55	100	1.64
DSX0470F03	4.7	●	5	15	50	80	0.86	DSX0910F03	9.1	●	10	29	56	106	1.66
DSX0480F03	4.8	●	5	15.3	50	80	0.87	DSX0920F03	9.2	●	10	29.3	56	106	1.67
DSX0490F03	4.9	●	5	15.6	50	80	0.89	DSX0930F03	9.3	●	10	29.6	56	106	1.69
DSX0500F03	5	●	5	15.9	50	80	0.91	DSX0940F03	9.4	●	10	29.9	56	106	1.71
DSX0510F03	5.1	●	6	16.2	52	82	0.93	DSX0950F03	9.5	●	10	30.2	56	106	1.73
DSX0520F03	5.2	●	6	16.6	52	82	0.95	DSX0960F03	9.6	●	10	30.6	56	106	1.75
DSX0530F03	5.3	●	6	16.9	52	82	0.96	DSX0970F03	9.7	●	10	30.9	56	106	1.77
DSX0540F03	5.4	●	6	17.2	52	82	0.98	DSX0980F03	9.8	●	10	31.2	56	106	1.78
DSX0550F03	5.5	●	6	17.5	52	82	1	DSX0990F03	9.9	●	10	31.5	56	106	1.8
DSX0560F03	5.6	●	6	17.8	52	82	1.02	DSX1000F03	10	●	10	31.8	56	106	1.82
DSX0570F03	5.7	●	6	18.1	52	82	1.04	DSX1030F03	10.3	●	11	32.8	61	116	1.87
DSX0580F03	5.8	●	6	18.5	52	82	1.06	DSX1050F03	10.5	●	11	33.4	61	116	1.91
DSX0590F03	5.9	●	6	18.8	52	82	1.07	DSX1080F03	10.8	●	11	34.4	61	116	1.97
DSX0600F03	6	●	6	19.1	52	82	1.09	DSX1100F03	11	●	11	35	61	116	2
DSX0610F03	6.1	●	7	19.4	53	86	1.11	DSX1180F03	11.8	●	12	37.5	62	122	2.15
DSX0620F03	6.2	●	7	19.7	53	86	1.13	DSX1210F03	12.1	●	13	38.5	63	128	2.2
DSX0630F03	6.3	●	7	20.1	53	86	1.15	DSX1250F03	12.5	●	13	39.8	63	128	2.27
DSX0640F03	6.4	●	7	20.4	53	86	1.16	DSX1300F03	13	●	13	41.4	63	128	2.37
DSX0650F03	6.5	●	7	20.7	53	86	1.18	DSX1370F03	13.7	●	14	43.6	64	134	2.49
DSX0660F03	6.6	●	7	21	53	88	1.2	DSX1400F03	14	●	14	44.5	64	134	2.55
DSX0670F03	6.7	●	7	21.3	53	88	1.22	DSX1410F03	14.1	●	15	44.9	65	140	2.57
DSX0680F03	6.8	●	7	21.6	53	88	1.24	DSX1550F03	15.5	●	16	49.3	66	146	2.82
DSX0690F03	6.9	●	7	22	53	88	1.26	DSX1600F03	16	●	16	50.9	66	146	2.91
DSX0700F03	7	●	7	22.3	53	88	1.27	DSX1650F03	16.5	●	17	52.5	67	152	3
DSX0710F03	7.1	●	8	22.6	54	92	1.29	DSX1750F03	17.5	●	18	55.7	68	158	3.18
DSX0720F03	7.2	●	8	22.9	54	92	1.31	DSX2000F03	20	●	20	63.6	70	170	3.64
DSX0730F03	7.3	●	8	23.2	54	92	1.33								

● : Line up

### STANDARD CUTTING CONDITIONS

See more information

e-catalog



# DSX-F05

Solid drill, L/D = 5, with coolant hole

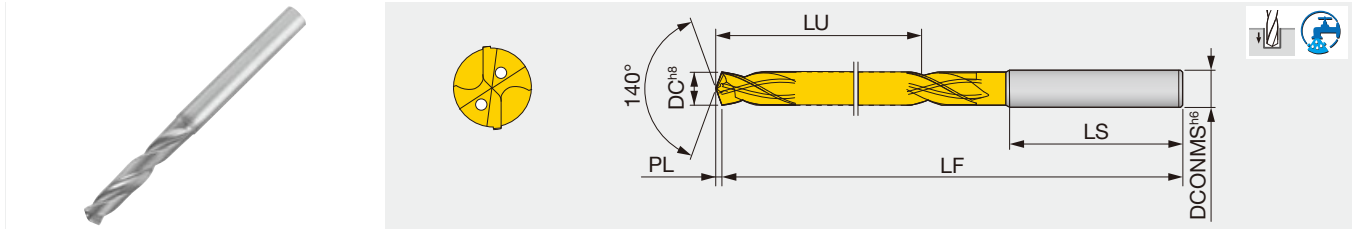

Metric	DC	AH180	DCONMS	LU	LS	LF	PL	Metric	DC	AH180	DCONMS	LU	LS	LF	PL
DSX0300F05	3	●	3	15.6	48	77	0.55	DSX0730F05	7.3	●	8	37.8	54	114	1.33
DSX0310F05	3.1	●	4	16.1	48	81	0.56	DSX0740F05	7.4	●	8	38.4	54	114	1.35
DSX0320F05	3.2	●	4	16.6	48	81	0.58	DSX0750F05	7.5	●	8	38.9	54	114	1.36
DSX0330F05	3.3	●	4	17.1	48	81	0.6	DSX0760F05	7.6	●	8	39.4	54	118	1.38
DSX0340F05	3.4	●	4	17.6	48	81	0.62	DSX0770F05	7.7	●	8	39.9	54	118	1.4
DSX0350F05	3.5	●	4	18.1	48	81	0.64	DSX0780F05	7.8	●	8	40.4	54	118	1.42
DSX0360F05	3.6	●	4	18.7	48	85	0.66	DSX0790F05	7.9	●	8	40.9	54	118	1.44
DSX0370F05	3.7	●	4	19.2	48	85	0.67	DSX0800F05	8	●	8	41.5	54	118	1.46
DSX0380F05	3.8	●	4	19.7	48	85	0.69	DSX0810F05	8.1	●	9	42	55	127	1.47
DSX0390F05	3.9	●	4	20.2	48	85	0.71	DSX0820F05	8.2	●	9	42.5	55	127	1.49
DSX0400F05	4	●	4	20.7	48	85	0.73	DSX0830F05	8.3	●	9	43	55	127	1.51
DSX0410F05	4.1	●	5	21.3	50	91	0.75	DSX0840F05	8.4	●	9	43.5	55	127	1.53
DSX0420F05	4.2	●	5	21.8	50	91	0.76	DSX0850F05	8.5	●	9	44	55	127	1.55
DSX0430F05	4.3	●	5	22.3	50	91	0.78	DSX0860F05	8.6	●	9	44.6	55	127	1.57
DSX0440F05	4.4	●	5	22.8	50	91	0.8	DSX0870F05	8.7	●	9	45.1	55	127	1.58
DSX0450F05	4.5	●	5	23.3	50	91	0.82	DSX0880F05	8.8	●	9	45.6	55	127	1.6
DSX0460F05	4.6	●	5	23.8	50	94	0.84	DSX0890F05	8.9	●	9	46.1	55	127	1.62
DSX0470F05	4.7	●	5	24.4	50	94	0.86	DSX0900F05	9	●	9	46.6	55	127	1.64
DSX0480F05	4.8	●	5	24.9	50	94	0.87	DSX0910F05	9.1	●	10	47.2	56	136	1.66
DSX0490F05	4.9	●	5	25.4	50	94	0.89	DSX0920F05	9.2	●	10	47.7	56	136	1.67
DSX0500F05	5	●	5	25.9	50	94	0.91	DSX0930F05	9.3	●	10	48.2	56	136	1.69
DSX0510F05	5.1	●	6	26.4	52	96	0.93	DSX0940F05	9.4	●	10	48.7	56	136	1.71
DSX0520F05	5.2	●	6	26.9	52	96	0.95	DSX0950F05	9.5	●	10	49.2	56	136	1.73
DSX0530F05	5.3	●	6	27.5	52	96	0.96	DSX0960F05	9.6	●	10	49.8	56	136	1.75
DSX0540F05	5.4	●	6	28	52	96	0.98	DSX0970F05	9.7	●	10	50.3	56	136	1.77
DSX0550F05	5.5	●	6	28.5	52	96	1	DSX0980F05	9.8	●	10	50.8	56	136	1.78
DSX0560F05	5.6	●	6	29	52	100	1.02	DSX0990F05	9.9	●	10	51.3	56	136	1.8
DSX0570F05	5.7	●	6	29.5	52	100	1.04	DSX1000F05	10	●	10	51.8	56	136	1.82
DSX0580F05	5.8	●	6	30.1	52	100	1.06	DSX1020F05	10.2	●	11	52.9	61	149	1.86
DSX0590F05	5.9	●	6	30.6	52	100	1.07	DSX1030F05	10.3	●	11	53.4	61	149	1.87
DSX0600F05	6	●	6	31.1	52	100	1.09	DSX1050F05	10.5	●	11	54.4	61	149	1.91
DSX0610F05	6.1	●	7	31.6	53	105	1.11	DSX1100F05	11	●	11	57	61	149	2
DSX0620F05	6.2	●	7	32.1	53	105	1.13	DSX1110F05	11.1	●	12	57.5	62	158	2.02
DSX0630F05	6.3	●	7	32.6	53	105	1.15	DSX1150F05	11.5	●	12	59.6	62	158	2.09
DSX0640F05	6.4	●	7	33.2	53	105	1.16	DSX1180F05	11.8	●	12	61.1	62	158	2.15
DSX0650F05	6.5	●	7	33.7	53	105	1.18	DSX1220F05	12.2	●	13	63.2	63	167	2.22
DSX0660F05	6.6	●	7	34.2	53	109	1.2	DSX1300F05	13	●	13	67.4	63	167	2.37
DSX0670F05	6.7	●	7	34.7	53	109	1.22	DSX1350F05	13.5	●	14	70	64	176	2.46
DSX0680F05	6.8	●	7	35.2	53	109	1.24	DSX1400F05	14	●	14	72.5	64	176	2.55
DSX0690F05	6.9	●	7	35.8	53	109	1.26	DSX1410F05	14.1	●	15	73.1	65	185	2.57
DSX0700F05	7	●	7	36.3	53	109	1.27	DSX1600F05	16	●	16	82.9	66	194	2.91
DSX0710F05	7.1	●	8	36.8	54	114	1.29	DSX1750F05	17.5	●	18	90.7	68	212	3.18
DSX0720F05	7.2	●	8	37.3	54	114	1.31	DSX1800F05	18	●	18	93.3	68	212	3.28

● : Line up

## STANDARD CUTTING CONDITIONS

See more information

e-catalog



Grade  
Insert  
Ext. Toolholder  
Int. Toolholder  
Threading  
Grooving  
Miniature tool  
Milling cutter  
Endmill  
Drilling tool  
Tooling System  
Index  
User's Guide

# SOLIDDRILL

## DSX-F08

Solid drill, L/D = 8, with coolant hole

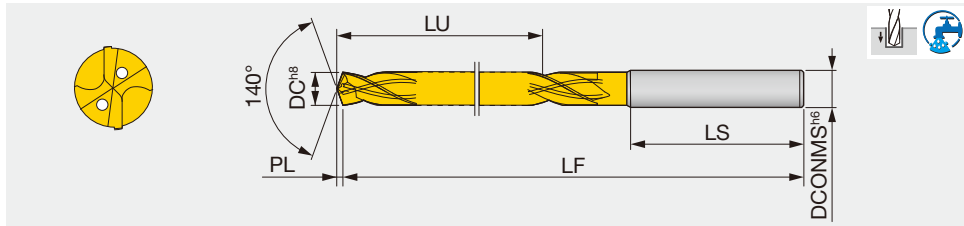

Metric	DC	AH180	DCONMS	LU	LS	LF	PL	Metric	DC	AH180	DCONMS	LU	LS	LF	PL
DSX0300F08	3	●	3	33.6	48	86	0.55	DSX0750F08	7.5	●	8	84.4	54	137	1.36
DSX0350F08	3.5	●	4	39.6	48	92	0.64	DSX0800F08	8	●	8	89.5	54	142	1.46
DSX0400F08	4	●	4	44.7	48	97	0.73	DSX0830F08	8.3	●	9	95.5	55	154	1.51
DSX0450F08	4.5	●	5	50.8	50	105	0.82	DSX0850F08	8.5	●	9	95.6	55	154	1.55
DSX0500F08	5	●	5	55.9	50	110	0.91	DSX0900F08	9	●	9	100.6	55	154	1.64
DSX0510F08	5.1	●	6	61.9	52	113	0.93	DSX0950F08	9.5	●	10	106.7	56	166	1.73
DSX0550F08	5.5	●	6	62	52	113	1	DSX1000F08	10	●	10	111.8	56	166	1.82
DSX0600F08	6	●	6	67.1	52	118	1.09	DSX1100F08	11	●	11	90	61	182	2
DSX0650F08	6.5	●	7	73.2	53	125	1.18	DSX1300F08	13	●	13	106.4	63	206	2.37
DSX0700F08	7	●	7	78.3	53	130	1.27								

● : Line up

### STANDARD CUTTING CONDITIONS

See more information

e-catalog



## DSE-F02

Solid drill, L/D = 2, without coolant hole

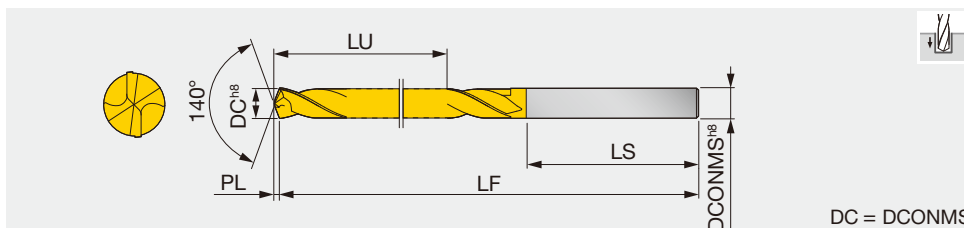

DC = DCONMS

Metric	DC	AH180	DCONMS	LU	LS	LF	PL	Metric	DC	AH180	DCONMS	LU	LS	LF	PL
DSE0300F02	3	●	3	16.6	30	46	0.55	DSE0640F02	6.4	●	6.4	32.2	39	70	1.16
DSE0320F02	3.2	●	3.2	18.6	31	49	0.58	DSE0650F02	6.5	●	6.5	32.2	39	70	1.18
DSE0340F02	3.4	●	3.4	20.6	32	52	0.62	DSE0680F02	6.8	●	6.8	35.2	40	74	1.24
DSE0350F02	3.5	●	3.5	20.6	32	52	0.64	DSE0700F02	7	●	7	35.3	40	74	1.27
DSE0400F02	4	●	4	22.7	33	55	0.73	DSE0750F02	7.5	●	7.5	35.4	40	74	1.36
DSE0430F02	4.3	●	4.3	24.8	34	58	0.78	DSE0800F02	8	●	8	38.5	42	79	1.46
DSE0450F02	4.5	●	4.5	24.8	34	58	0.82	DSE0850F02	8.5	●	8.5	38.6	42	79	1.55
DSE0500F02	5	●	5	26.9	36	62	0.91	DSE0900F02	9	●	9	41.6	44	84	1.64
DSE0510F02	5.1	●	5.1	26.9	36	62	0.93	DSE0950F02	9.5	●	9.5	41.7	44	84	1.73
DSE0550F02	5.5	●	5.5	29	38	66	1	DSE1000F02	10	●	10	44.8	46	89	1.82
DSE0560F02	5.6	●	5.6	29	38	66	1.02	DSE1500F02	15	●	15	58.7	55	111	2.73
DSE0600F02	6	●	6	29.1	38	66	1.09								

● : Line up

### STANDARD CUTTING CONDITIONS

See more information

e-catalog





# DSE-F03

Solid drill, L/D = 3, without coolant hole

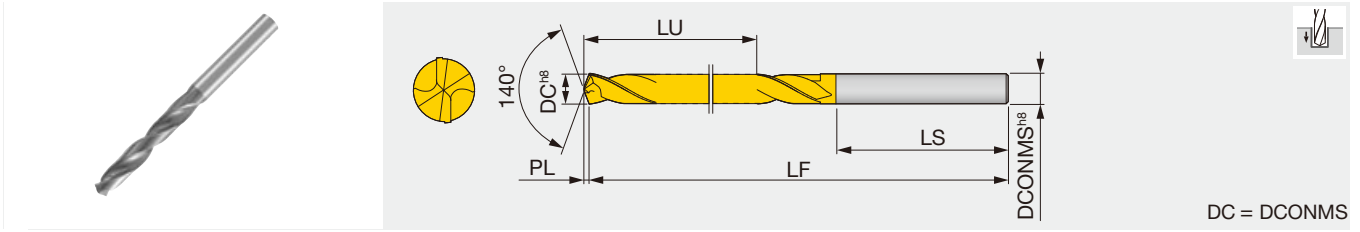

Metric	DC	AH180	DCONMS	LU	LS	LF	PL	Metric	DC	AH180	DCONMS	LU	LS	LF	PL
DSE0300F03	3	●	3	21.6	39	60	0.55	DSE0700F03	7	●	7	44.3	40	83	1.27
DSE0320F03	3.2	●	3.2	24.6	36	60	0.58	DSE0740F03	7.4	●	7.4	46.4	42	87	1.35
DSE0340F03	3.4	●	3.4	24.6	36	60	0.62	DSE0750F03	7.5	●	7.5	46.4	42	87	1.36
DSE0350F03	3.5	●	3.5	24.6	36	60	0.64	DSE0800F03	8	●	8	49.5	42	90	1.46
DSE0400F03	4	●	4	27.7	33	60	0.73	DSE0850F03	8.5	●	8.5	54.6	43	96	1.55
DSE0430F03	4.3	●	4.3	29.8	34	63	0.78	DSE0860F03	8.6	●	8.6	56.6	43	98	1.57
DSE0450F03	4.5	●	4.5	29.8	34	63	0.82	DSE0900F03	9	●	9	56.6	43	98	1.64
DSE0500F03	5	●	5	32.9	36	68	0.91	DSE0950F03	9.5	●	9.5	59.7	44	102	1.73
DSE0510F03	5.1	●	5.1	34.9	38	72	0.93	DSE1000F03	10	●	10	61.8	45	105	1.82
DSE0550F03	5.5	●	5.5	35	38	72	1	DSE1030F03	10.3	●	10.3	67.9	46	112	1.87
DSE0600F03	6	●	6	42.1	40	81	1.09	DSE1050F03	10.5	●	10.5	67.9	46	112	1.91
DSE0650F03	6.5	●	6.5	42.2	40	81	1.18	DSE1100F03	11	●	11	70	46	114	2
DSE0680F03	6.8	●	6.8	44.2	40	83	1.24	DSE1500F03	15	●	15	93.7	62	153	2.73

● : Line up

## STANDARD CUTTING CONDITIONS

See more information

e-catalog



Grade  
Insert  
Toolholder  
Ext. Toolholder  
Int. Toolholder  
Threading  
Grooving  
Miniature tool  
Milling cutter  
Endmill  
Drilling tool  
Tooling System  
User's Guide  
Index

A  
B  
C  
D  
E  
F  
G  
H  
I  
J  
K  
L  
M

# SOLIDDRILL

## FDCU

Solid drill, L/D = 5, 8 with coolant hole, for cast iron and Aluminum alloy

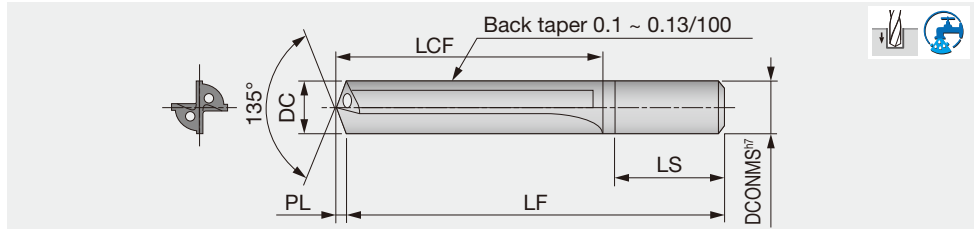

### L/D = 5

Inch	DC	G1F	DCONMS	LCF	LS	LF	PL
FDCU218S	0.219	●	0.236	1.935	1.57	3.54	0.045
FDCU265S	0.266	●	0.276	2.260	1.57	3.94	0.055
FDCU312S	0.313	●	0.315	2.585	1.65	4.33	0.065
FDCU328S	0.328	●	0.354	2.745	1.73	4.53	0.068

### L/D = 8

Inch	DC	G1F	DCONMS	LCF	LS	LF	PL
FDCU218L	0.219	●	0.236	2.643	1.57	4.33	0.045
FDCU250L	0.250	●	0.276	2.887	1.57	4.53	0.052
FDCU265L	0.266	●	0.276	3.086	1.57	4.72	0.055
FDCU281L	0.281	●	0.315	3.326	1.65	4.92	0.058
FDCU328L	0.328	●	0.354	3.769	1.73	5.51	0.068
FDCU343L	0.344	●	0.354	3.969	1.73	5.71	0.071

● : Line up

DC (in)	Tolerance (in)
0.203" ≤ DC ≤ 0.234"	+0.0008" ~ +0.0004"
0.234" < DC ≤ 0.328"	+0.0010" ~ +0.0006"

DC (in)	Tolerance (in)
0.219" ≤ DC	+0.0008" ~ +0.0004"
0.250" < DC ≤ 0.344"	+0.0010" ~ +0.0006"

## STANDARD CUTTING CONDITIONS

Please scan below.

e-catalog



## FDC-L L/D=8

Solid drill, L/D = 8, with coolant hole, for cast iron and Aluminum alloy

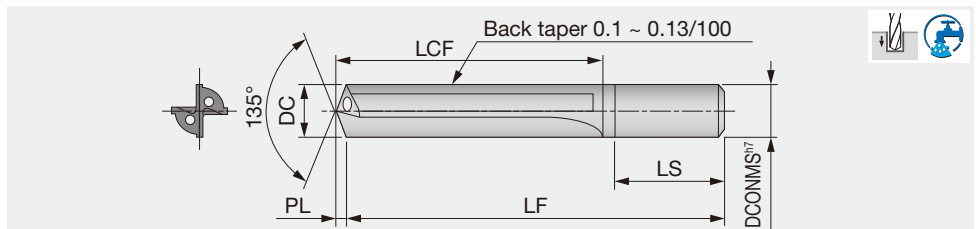

Metric	DC	G1F	DCONMS	LCF	LS	LF	PL
FDC0500L	5	●	5	56	38	95	1.04
FDC0550L	5.5	●	6	62.1	40	105	1.14
FDC0600L	6	●	6	67.2	40	110	1.24
FDC0620L	6.2	●	7	73.3	40	115	1.28
FDC0650L	6.5	●	7	73.4	40	115	1.35
FDC0680L	6.8	●	7	78.4	40	120	1.41
FDC0700L	7	●	7	78.5	40	120	1.45

Metric	DC	G1F	DCONMS	LCF	LS	LF	PL
FDC0750L	7.5	●	8	84.6	42	125	1.55
FDC0780L	7.8	●	8	89.6	42	130	1.62
FDC0800L	8	●	8	89.7	42	130	1.66
FDC0850L	8.5	●	9	95.8	44	140	1.76
FDC0860L	8.6	●	9	100.8	44	145	1.78
FDC0900L	9	●	9	100.9	44	145	1.86
FDC0950L	9.5	●	10	107	44	150	1.97
FDC1000L	10	●	10	112.1	46	160	2.07

● : Line up

DC (mm)	Tolerance (mm)
5 ≤ DC ≤ 6	+0.02 ~ +0.01
6 < DC ≤ 10	+0.025 ~ +0.015

### Coolant

- Supply coolant through the inside of a drill.
- The coolant pressure should be 0.5 to 1 MPa.
- Use water-soluble coolant containing a large amount of extreme pressure additive.

## STANDARD CUTTING CONDITIONS

Please scan below.

e-catalog



# DMXU-VS

Solid drill, L/D = 2, without coolant hole

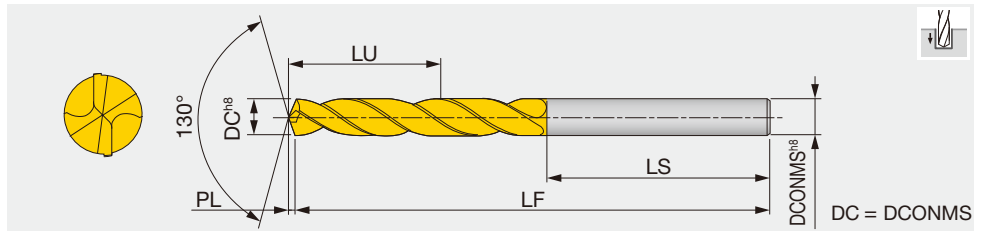
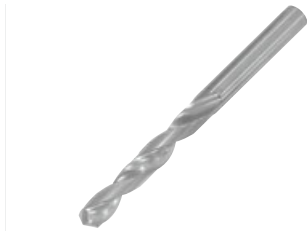

Inch	DC	AH170	DCONMS	LCF	LS	LF	Inch	DC	AH170	DCONMS	LCF	LS	LF
DMXU1110VS	#34	●	0.111	0.630	1.180	1.810	DMXU2812VS	9/32	●	0.281	1.340	1.570	2.910
DMXU1130VS	#33	●	0.113	0.630	1.180	1.810	DMXU2900VS	#L	●	0.290	1.340	1.570	2.910
DMXU1160VS	#32	●	0.116	0.630	1.180	1.810	DMXU2950VS	#M	●	0.295	1.340	1.570	2.910
DMXU1200VS	#31	●	0.120	0.708	1.220	1.930	DMXU2969VS	19/64	●	0.297	1.460	1.650	3.110
DMXU1250VS	1/8	●	0.125	0.708	1.220	1.930	DMXU3020VS	#N	●	0.302	1.460	1.650	3.110
DMXU1285VS	#30	●	0.129	0.708	1.220	1.930	DMXU3125VS	5/16	●	0.313	1.460	1.650	3.110
DMXU1360VS	#29	●	0.136	0.787	1.260	2.050	DMXU3160VS	#O	●	0.316	1.460	1.650	3.110
DMXU1405VS	#28	●	0.141	0.787	1.260	2.050	DMXU3230VS	#P	●	0.323	1.460	1.650	3.110
DMXU1406VS	9/64	●	0.141	0.787	1.260	2.050	DMXU3281VS	21/64	●	0.328	1.460	1.650	3.110
DMXU1440VS	#27	●	0.144	0.787	1.260	2.050	DMXU3320VS	#Q	●	0.332	1.460	1.650	3.110
DMXU1470VS	#26	●	0.147	0.886	1.300	2.170	DMXU3390VS	#R	●	0.339	1.570	1.730	3.310
DMXU1495VS	#25	●	0.150	0.886	1.300	2.170	DMXU3438VS	11/32	●	0.344	1.570	1.730	3.310
DMXU1520VS	#24	●	0.152	0.886	1.300	2.170	DMXU3480VS	#S	●	0.348	1.570	1.730	3.310
DMXU1540VS	#23	●	0.154	0.886	1.300	2.170	DMXU3580VS	#T	●	0.358	1.570	1.730	3.310
DMXU1562VS	5/32	●	0.156	0.886	1.300	2.170	DMXU3594VS	23/64	●	0.359	1.570	1.730	3.310
DMXU1570VS	#22	●	0.157	0.886	1.300	2.170	DMXU3680VS	#U	●	0.368	1.570	1.730	3.310
DMXU1590VS	#21	●	0.159	0.886	1.300	2.170	DMXU3750VS	3/8	●	0.375	1.690	1.810	3.500
DMXU1610VS	#20	●	0.161	0.886	1.300	2.170	DMXU3770VS	#V	●	0.377	1.690	1.810	3.500
DMXU1660VS	#19	●	0.166	0.945	1.340	2.280	DMXU3860VS	#W	●	0.386	1.690	1.810	3.500
DMXU1695VS	#18	●	0.170	0.945	1.340	2.280	DMXU3906VS	25/64	●	0.391	1.690	1.810	3.500
DMXU1719VS	11/64	●	0.172	0.945	1.340	2.280	DMXU3970VS	#X	●	0.397	1.690	1.810	3.500
DMXU1730VS	#17	●	0.173	0.945	1.340	2.280	DMXU4040VS	#Y	●	0.404	1.690	1.810	3.500
DMXU1770VS	#16	●	0.177	0.945	1.340	2.280	DMXU4062VS	13/32	●	0.406	1.690	1.810	3.500
DMXU1800VS	#15	●	0.180	0.945	1.340	2.280	DMXU4130VS	#Z	●	0.413	1.690	1.810	3.500
DMXU1820VS	#14	●	0.182	0.945	1.340	2.280	DMXU4219VS	27/64	●	0.422	1.850	1.890	3.740
DMXU1850VS	#13	●	0.185	0.945	1.340	2.280	DMXU4375VS	7/16	●	0.438	1.850	1.890	3.740
DMXU1875VS	3/16	●	0.188	1.020	1.420	2.440	DMXU4531VS	29/64	●	0.453	1.850	1.890	3.740
DMXU1890VS	#12	●	0.189	1.020	1.420	2.440	DMXU4688VS	15/32	●	0.469	2.010	2.010	4.020
DMXU1910VS	#11	●	0.191	1.020	1.420	2.440	DMXU4844VS	31/64	●	0.484	2.010	2.010	4.020
DMXU1935VS	#10	●	0.194	1.020	1.420	2.440	DMXU5000VS	1/2	●	0.500	2.010	2.010	4.020
DMXU1960VS	#9	●	0.196	1.020	1.420	2.440	DMXU5050VS	TUBE	●	0.505	2.010	2.010	4.020
DMXU1990VS	#8	●	0.199	1.020	1.420	2.440	DMXU5156VS	33/64	●	0.516	2.010	2.010	4.020
DMXU2010VS	#7	●	0.201	1.020	1.420	2.440	DMXU5312VS	17/32	●	0.531	2.130	2.090	4.210
DMXU2031VS	13/64	●	0.203	1.020	1.420	2.440	DMXU5469VS	35/64	●	0.547	2.130	2.090	4.210
DMXU2040VS	#6	●	0.204	1.020	1.420	2.440	DMXU5625VS	9/16	●	0.563	2.200	2.170	4.370
DMXU2055VS	#5	●	0.206	1.020	1.420	2.440	DMXU5781VS	37/64	●	0.578	2.200	2.170	4.370
DMXU2090VS	#4	●	0.209	1.100	1.500	2.600	DMXU5937VS	19/32	●	0.594	2.280	2.240	4.530
DMXU2130VS	#3	●	0.213	1.100	1.500	2.600	DMXU6094VS	39/64	●	0.609	2.280	2.240	4.530
DMXU2188VS	7/32	●	0.219	1.100	1.500	2.600	DMXU6250VS	5/8	●	0.625	2.280	2.240	4.530
DMXU2210VS	#2	●	0.221	1.100	1.500	2.600	DMXU6330VS	TUBE	●	0.633	2.360	2.320	4.690
DMXU2280VS	#1	●	0.228	1.100	1.500	2.600	DMXU6406VS	41/64	●	0.641	2.360	2.320	4.690
DMXU2344VS	15/64	●	0.234	1.100	1.500	2.600	DMXU6562VS	21/32	●	0.656	2.360	2.320	4.690
DMXU2380VS	#B	●	0.238	1.220	1.540	2.760	DMXU6875VS	11/16	●	0.688	2.440	2.400	4.850
DMXU2420VS	#C	●	0.242	1.220	1.540	2.760	DMXU7031VS	45/64	●	0.703	2.440	2.400	4.850
DMXU2460VS	#D	●	0.246	1.220	1.540	2.760	DMXU7187VS	23/32	●	0.719	2.520	2.480	5.000
DMXU2500VS	1/4	●	0.250	1.220	1.540	2.760	DMXU7344VS	47/64	●	0.734	2.520	2.480	5.000
DMXU2570VS	#F	●	0.257	1.220	1.540	2.760	DMXU7500VS	3/4	●	0.750	2.600	2.560	5.160
DMXU2610VS	#G	●	0.261	1.220	1.540	2.760	DMXU7590VS	TUBE	●	0.759	2.600	2.600	5.160
DMXU2656VS	17/64	●	0.266	1.340	1.570	2.910	DMXU7656VS	49/64	●	0.766	2.600	2.560	5.160
DMXU2660VS	#H	●	0.266	1.340	1.570	2.910	DMXU7812VS	25/32	●	0.781	2.600	2.560	5.160
DMXU2720VS	#I	●	0.272	1.340	1.570	2.910							
DMXU2770VS	#J	●	0.277	1.340	1.570	2.910							
DMXU2810VS	#K	●	0.281	1.340	1.570	2.910							

Cutting fluid should be sufficiently supplied to the drill point and the entrance of the hole. ● : Line up  
 Use a water soluble cutting fluid containing relatively high content of extreme pressure additive for heavy duty cutting or use a water-insoluble cutting fluid.

## STANDARD CUTTING CONDITIONS

See more information

e-catalog



# SOLIDDRILL

## DMXU-VM

Solid drill, L/D = 3, without coolant hole

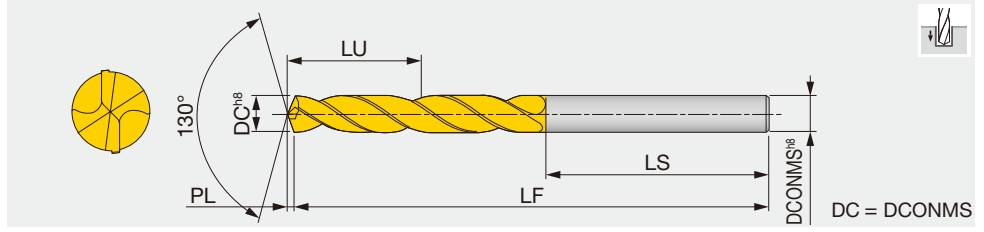

Inch	DC	AH170	DCONMS	LCF	LS	LF	Inch	DC	AH170	DCONMS	LCF	LS	LF
DMXU1990VM	#8	●	0.199	1.340	1.500	2.830	DMXU5000VM	1/2	●	0.500	3.070	2.320	5.390
DMXU2010VM	#7	●	0.201	1.340	1.500	2.830	DMXU5050VM	TUBE	●	0.505	3.070	2.320	5.390
DMXU2031VM	13/64	●	0.203	1.340	1.500	2.830	DMXU5156VM	33/64	●	0.516	3.310	2.360	5.670
DMXU2040VM	#6	●	0.204	1.340	1.500	2.830	DMXU5312VM	17/32	●	0.531	3.310	2.360	5.670
DMXU2055VM	#5	●	0.206	1.340	1.500	2.830	DMXU5469VM	35/64	●	0.547	3.390	2.400	5.790
DMXU2090VM	#4	●	0.209	1.340	1.500	2.830	DMXU5625VM	9/16	●	0.562	3.500	2.440	5.940
DMXU2130VM	#3	●	0.213	1.340	1.500	2.830	DMXU5781VM	37/64	●	0.578	3.580	2.440	6.030
DMXU2188VM	7/32	●	0.219	1.420	1.500	2.910	DMXU5937VM	19/32	●	0.594	3.700	2.480	6.180
DMXU2210VM	#2	●	0.221	1.340	1.500	2.910	DMXU6094VM	39/64	●	0.609	3.700	2.480	6.180
DMXU2280VM	#1	●	0.228	1.340	1.500	2.910	DMXU6250VM	5/8	●	0.625	3.780	2.520	6.300
DMXU2344VM	15/64	●	0.234	1.610	1.560	3.190	DMXU6330VM	TUBE	●	0.633	4.020	2.400	6.570
DMXU2380VM	#B	●	0.238	1.340	1.580	3.190	DMXU6406VM	41/64	●	0.641	4.020	2.400	6.570
DMXU2420VM	#C	●	0.242	1.340	1.580	3.190	DMXU6562VM	21/32	●	0.656	4.020	2.400	6.570
DMXU2460VM	#D	●	0.246	1.340	1.580	3.190	DMXU6875VM	11/16	●	0.688	4.020	2.400	6.570
DMXU2500VM	1/4	●	0.250	1.340	1.580	3.190	DMXU7031VM	45/64	●	0.703	4.020	2.400	6.570
DMXU2570VM	#F	●	0.257	1.690	1.570	3.270	DMXU7187VM	23/32	●	0.719	4.490	2.400	7.050
DMXU2610VM	#G	●	0.261	1.690	1.570	3.270	DMXU7344VM	47/64	●	0.734	4.490	2.400	7.050
DMXU2656VM	17/64	●	0.266	1.690	1.570	3.270	DMXU7500VM	3/4	●	0.750	4.490	2.400	7.050
DMXU2660VM	#H	●	0.266	1.690	1.570	3.270	DMXU7590VM	TUBE	●	0.759	4.490	2.400	7.050
DMXU2720VM	#I	●	0.272	1.690	1.570	3.270	DMXU7656VM	49/64	●	0.766	4.490	2.400	7.050
DMXU2770VM	#J	●	0.277	1.770	1.650	3.430	DMXU7812VM	25/32	●	0.781	4.490	2.400	7.050
DMXU2810VM	#K	●	0.281	1.770	1.650	3.430							
DMXU2812VM	9/32	●	0.281	1.770	1.650	3.430							
DMXU2900VM	#L	●	0.290	1.770	1.650	3.430							
DMXU2950VM	#M	●	0.295	1.770	1.650	3.430							
DMXU2969VM	19/64	●	0.297	1.890	1.650	3.540							
DMXU3020VM	#N	●	0.302	1.770	1.650	3.540							
DMXU3125VM	5/16	●	0.313	1.770	1.650	3.540							
DMXU3160VM	#O	●	0.316	2.090	1.690	3.780							
DMXU3230VM	#P	●	0.323	2.090	1.690	3.780							
DMXU3281VM	21/64	●	0.328	2.090	1.690	3.780							
DMXU3320VM	#Q	●	0.332	2.090	1.690	3.780							
DMXU3390VM	#R	●	0.339	2.170	1.690	3.860							
DMXU3438VM	11/32	●	0.344	2.170	1.690	3.860							
DMXU3480VM	#S	●	0.348	2.170	1.690	3.860							
DMXU3580VM	#T	●	0.358	2.280	1.730	4.020							
DMXU3594VM	23/64	●	0.359	2.280	1.730	4.020							
DMXU3680VM	#U	●	0.368	2.280	1.730	4.020							
DMXU3750VM	3/8	●	0.375	2.360	1.770	4.130							
DMXU3770VM	#V	●	0.377	2.360	1.770	4.130							
DMXU3860VM	#W	●	0.386	2.360	1.770	4.130							
DMXU3906VM	25/64	●	0.390	2.360	1.770	4.130							
DMXU3970VM	#X	●	0.397	2.600	1.810	4.410							
DMXU4040VM	#Y	●	0.404	2.600	1.810	4.410							
DMXU4062VM	13/32	●	0.406	2.600	1.810	4.410							
DMXU4130VM	#Z	●	0.413	2.600	1.810	4.410							
DMXU4219VM	27/64	●	0.422	2.670	1.810	4.490							
DMXU4375VM	7/16	●	0.438	2.800	1.850	4.650							
DMXU4531VM	29/64	●	0.453	2.870	1.890	4.760							
DMXU4688VM	15/32	●	0.469	2.870	1.890	4.760							
DMXU4844VM	31/64	●	0.484	2.990	2.320	5.320							

Cutting fluid should be sufficiently supplied to the drill point and the entrance of the hole.  
Use a water soluble cutting fluid containing relatively high content of extreme pressure additive for heavy duty cutting or use a water-insoluble cutting fluid.

● : Line up

### STANDARD CUTTING CONDITIONS

See more information

e-catalog



## DMX (S type)

Solid drill, L/D = 2, without coolant hole

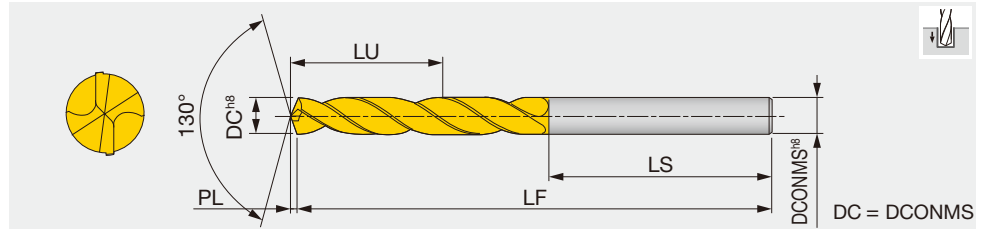
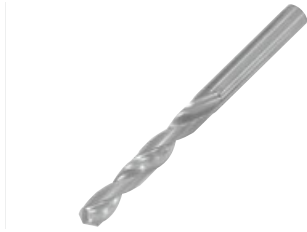

Metric	DC	AH170	DCONMS	LU	LS	LF	PL
DMX037S	3.7	●	3.7	20.9	32	52	0.86
DMX038S	3.8	●	3.8	22.9	33	55	0.89
DMX039S	3.9	●	3.9	22.9	33	55	0.91
DMX040S	4	●	4	22.9	33	55	0.93
DMX051S	5.1	●	5.1	27.2	36	62	1.19
DMX061S	6.1	●	6.1	32.4	39	70	1.42
DMX062S	6.2	●	6.2	32.5	39	70	1.45
DMX068S	6.8	●	6.8	35.6	40	74	1.59
DMX070S	7	●	7	35.6	40	74	1.63

Metric	DC	AH170	DCONMS	LU	LS	LF	PL
DMX080S	8	●	8	38.9	42	79	1.87
DMX085S	8.5	●	8.5	39	42	79	1.98
DMX090S	9	●	9	42.1	44	84	2.1
DMX111S	11.1	●	11.1	49.6	48	95	2.59
DMX130S	13	●	13	54	51	102	3.03
DMX140S	14	●	14	57.3	53	107	3.26
DMX145S	14.5	●	14.5	59.4	55	111	3.38
DMX165S	16.5	●	16.5	63.9	59	119	3.85

● : Line up  
 • Cutting fluid should be sufficiently supplied to the drill point and the entrance of the hole. • Use a water-soluble cutting fluid.

## STANDARD CUTTING CONDITIONS

See more information

e-catalog



## DMX (M type)

Solid drill, L/D = 3, without coolant hole

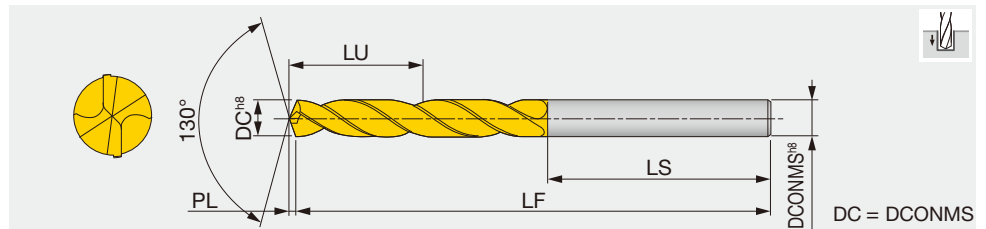

Metric	DC	AH170	DCONMS	LU	LS	LF	PL
DMX030M	3	●	3	21.7	39	60	0.7
DMX034M	3.4	●	3.4	24.8	36	60	0.79
DMX037M	3.7	●	3.7	27.9	33	60	0.86
DMX039M	3.9	●	3.9	27.9	33	60	0.91
DMX040M	4	●	4	27.9	33	60	0.93
DMX041M	4.1	●	4.1	30	34	63	0.96
DMX043M	4.3	●	4.3	30	34	63	1
DMX048M	4.8	●	4.8	33.1	36	68	1.12
DMX050M	5	●	5	33.2	36	68	1.17
DMX051M	5.1	●	5.1	35.2	38	72	1.19
DMX055M	5.5	●	5.5	35.3	38	72	1.28

Metric	DC	AH170	DCONMS	LU	LS	LF	PL
DMX058M	5.8	●	5.8	37.4	38	74	1.35
DMX061M	6.1	●	6.1	42.4	40	81	1.42
DMX068M	6.8	●	6.8	44.6	40	83	1.59
DMX078M	7.8	●	7.8	49.8	42	90	1.82
DMX080M	8	●	8	49.9	42	90	1.87
DMX110M	11	●	11	70.6	46	114	2.56
DMX127M	12.7	●	12.7	81	59	137	2.96
DMX138M	13.8	●	13.8	89.2	61	147	3.22
DMX148M	14.8	●	14.8	94.5	62	153	3.45
DMX165M	16.5	●	16.5	105.9	65	167	3.85

● : Line up  
 • Cutting fluid should be sufficiently supplied to the drill point and the entrance of the hole. • Use a water-soluble cutting fluid.

## STANDARD CUTTING CONDITIONS

See more information

e-catalog



# SOLIDDRILL

## DMX-FS

Solid drill, L/D = 2, without coolant hole

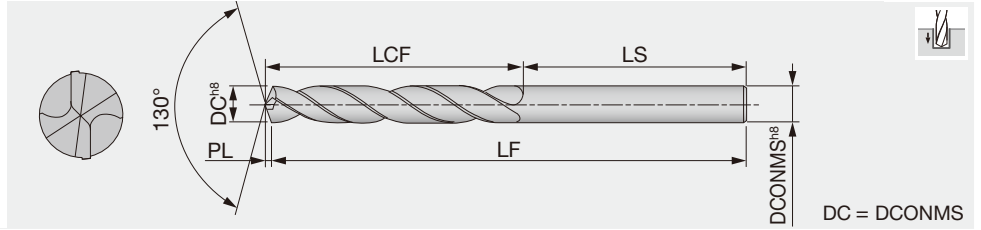
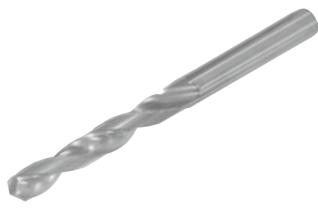

Metric	DC	MD20	LCF	LS	LF	PL	DC	Tolerance h8(mm)
DMX0600FS	6	●	29.4	38	66	1.4	6	0 ~ -0.018
DMX0700FS	7	●	35.6	40	74	1.63	7, 10	0 ~ -0.022
DMX1000FS	10	●	45.3	46	89	2.33		

● : Line up

### STANDARD CUTTING CONDITIONS

Please scan below.

e-catalog



## DMX-FM

Solid drill, L/D = 3, without coolant hole

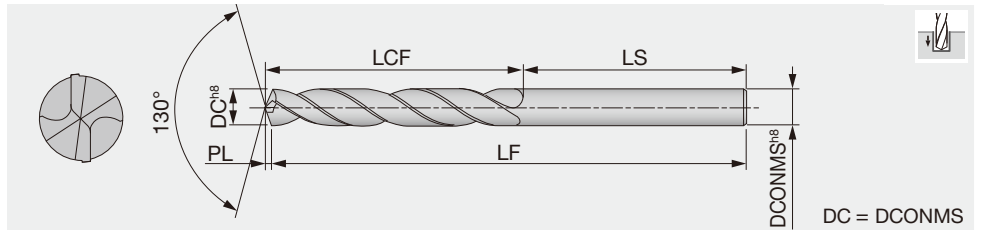

Metric	DC	MD20	LCF	LS	LF	PL	DC	Tolerance h8(mm)
DMX0600FM	6	●	42.4	40	81	1.4	6	0 ~ -0.018
DMX1250FM	12.5	●	78.9	59	135	2.91	12.5	0 ~ -0.027

● : Line up

### STANDARD CUTTING CONDITIONS

Please scan below.

e-catalog





## DMX-FL

Solid drill, L/D = 5, without coolant hole

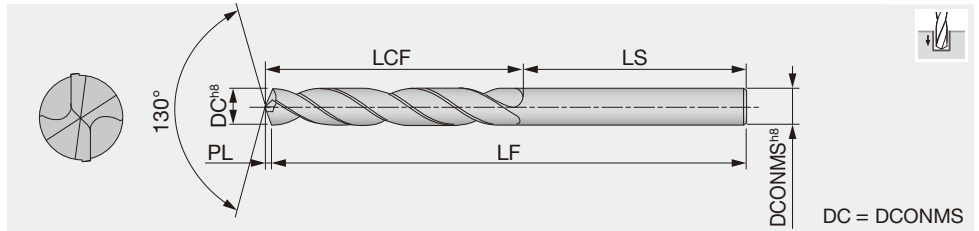

Metric	DC	MD20	LCF	LS	LF	PL	DC	Tolerance h8(mm)
DMX0300FL	3	●	27.7	39	66	0.7	3	0 ~ -0.014
DMX0400FL	4	●	35.9	33	68	0.93	4, 5	0 ~ -0.018
DMX0500FL	5	●	43.2	36	78	1.17	8.5	0 ~ -0.022
DMX0850FL	8.5	●	72	43	113	1.98		

● : Line up

## STANDARD CUTTING CONDITIONS

Please scan below.

e-catalog



## FDS

Solidrill, L/D = 3, without oil hole, for pre-tap hole drilling

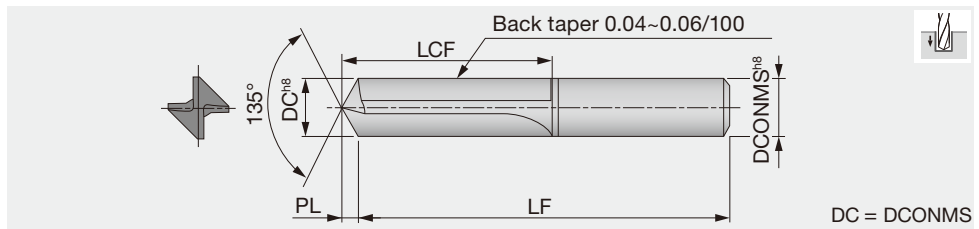

For bolt holes

Metric	DC	G1F	DCONMS	LCF	LF	PL	DC	Tolerance h8(mm)
FDS1100	11	●	11	57.3	120	2.28	11	0 ~ -0.027

● : Line up

## STANDARD CUTTING CONDITIONS

Please scan below.

e-catalog



# SOLID 4 FLUTES DRILL

## DSQ-E3

Solid drill, L/D = 3, DIN shank, without coolant hole, DIN shank

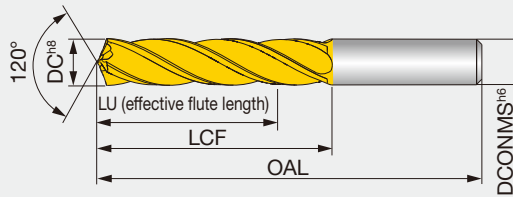

Inch	DC	AH9130	DCONMS	LU	LCF	OAL	Inch	DC	AH9130	DCONMS	LU	LCF	OAL
DSQ060-018-06E3	0.236	●	0.236	0.945	1.181	3.150	DSQ108-033-11E3	0.425	●	0.433	1.693	2.126	4.882
DSQ068-021-07E3	0.268	●	0.276	1.063	1.339	3.307	DSQ120-036-12E3	0.472	●	0.472	1.890	2.362	5.118
DSQ085-026-09E3	0.335	●	0.354	1.339	1.693	3.661	DSQ130-039-13E3	0.512	●	0.512	2.047	2.559	5.315
DSQ090-027-09E3	0.354	●	0.354	1.417	1.772	3.740	DSQ140-042-14E3	0.551	●	0.551	2.205	2.756	5.512
DSQ100-030-10E3	0.394	●	0.394	1.575	1.969	3.937	DSQ160-048-16E3	0.630	●	0.630	2.520	3.150	5.906
DSQ105-032-11E3	0.413	●	0.433	1.654	2.087	4.843							

● : Line up

Metric	DC	AH9130	DCONMS	LU	LCF	OAL	Metric	DC	AH9130	DCONMS	LU	LCF	OAL
DSQ060-018-06E3	6	●	6	24	30	80	DSQ108-033-11E3	10.8	●	11	43	54	124
DSQ068-021-07E3	6.8	●	7	27	34	84	DSQ120-036-12E3	12	●	12	48	60	130
DSQ085-026-09E3	8.5	●	9	34	43	93	DSQ130-039-13E3	13	●	13	52	65	135
DSQ090-027-09E3	9	●	9	36	45	95	DSQ140-042-14E3	14	●	14	56	70	140
DSQ100-030-10E3	10	●	10	40	50	100	DSQ160-048-16E3	16	●	16	64	80	150
DSQ105-032-11E3	10.5	●	11	42	53	123							

● : Line up

## DSQ-E5

Solid drill, L/D = 5, DIN shank, without coolant hole

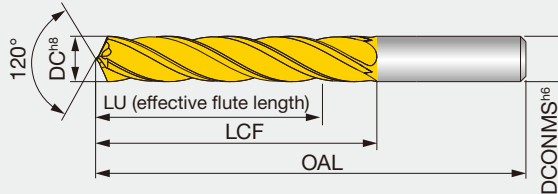

Inch	DC	AH9130	DCONMS	LU	LCF	OAL	Inch	DC	AH9130	DCONMS	LU	LCF	OAL
DSQ060-030-06E5	0.236	●	0.236	1.417	1.654	3.622	DSQ105-053-11E5	0.413	●	0.433	2.480	2.913	5.669
DSQ068-034-07E5	0.268	●	0.276	1.614	1.890	3.858	DSQ120-060-12E5	0.472	●	0.472	2.835	3.307	6.063
DSQ085-043-09E5	0.335	●	0.354	2.008	2.362	4.331	DSQ160-080-16E5	0.630	●	0.630	3.780	4.409	7.165
Metric	DC	AH9130	DCONMS	LU	LCF	OAL	Metric	DC	AH9130	DCONMS	LU	LCF	OAL
DSQ060-030-06E5	6	●	6	36	42	92	DSQ105-053-11E5	10.5	●	11	63	74	144
DSQ068-034-07E5	6.8	●	7	41	48	98	DSQ120-060-12E5	12	●	12	72	84	154
DSQ085-043-09E5	8.5	●	9	51	60	110	DSQ160-080-16E5	16	●	16	96	112	182

● : Line up

● : Line up

## STANDARD CUTTING CONDITIONS

ISO	Workpiece material	Brinell hardness (HB)	Cutting speed Vc (sfm)	Feed: f (ipr)	
				ø0.236" - ø0.390"	ø0.394" - ø0.630"
K	Gray cast irons Class 30, etc.	- 200	197 - 394	0.008 - 0.031	0.012 - 0.039
	Ductile cast irons 65-45-12, etc.	- 300	197 - 394	0.008 - 0.031	0.012 - 0.039

- The cutting parameters shown in the table are a starting guideline. Values should be varied depending on the power or rigidity of the machine. Optimum conditions should be selected depending on the actual chip control or damage on edges.
- When using the smaller diameter tools in each range, set the feed "f" to the lower values.
- When drilling with a depth deeper than L/D = 3, a pecking cycle or dwell operation should be considered depending on the actual chip control.

# MEMO

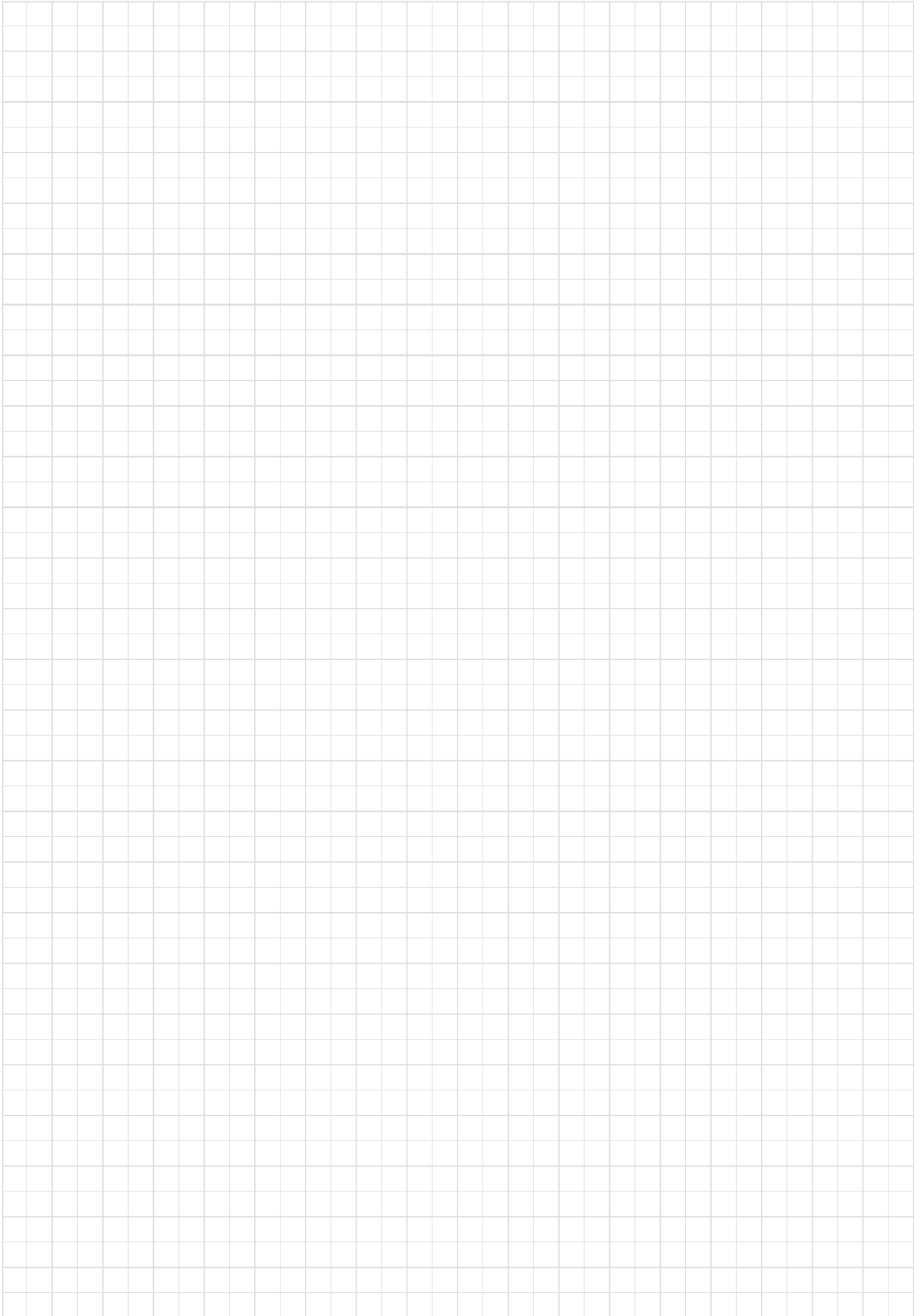





Grade	<b>A</b>
Insert	<b>B</b>
Ext. Toolholder	<b>C</b>
Int. Toolholder	<b>D</b>
Threading	<b>E</b>
Grooving	<b>F</b>
Miniature tool	<b>G</b>
Milling cutter	<b>H</b>
Endmill	<b>I</b>
Drilling tool	<b>J</b>
Tooling System	<b>K</b>
User's Guide	<b>L</b>
Index	<b>M</b>



TungSix-Drill

# Indexable drill

		Inch	Metric
	<h2>TUNGSIX-DRILL</h2> <p>Indexable drill with 6-corner inserts for high productivity</p> <p> <math>\varnothing 0.750'' - \varnothing 1.062''</math> , <math>\varnothing 20 \text{ mm} - \varnothing 54 \text{ mm}</math> L/D = 2, 3, 4</p> <p>J006 J070 -</p>	<input checked="" type="checkbox"/>	<input checked="" type="checkbox"/>
	<h2>TUNGDRILLTWISTED</h2> <p>Indexable drill with 4-corner inserts for various drilling applications</p> <p> <math>\varnothing 0.500'' - \varnothing 2.125''</math> , <math>\varnothing 12.5 \text{ mm} - \varnothing 54 \text{ mm}</math> L/D = 2, 3, 4, 5</p> <p>J006 J080 -</p>	<input checked="" type="checkbox"/>	<input checked="" type="checkbox"/>
	<h2>TUNGDRILLBIG</h2> <p>Large diameter drill with cartridges for TungSix-Drill and TungDrillTwisted inserts</p> <p> <math>\varnothing 2.250'' - \varnothing 3.157''</math> , <math>\varnothing 55 \text{ mm} - \varnothing 80 \text{ mm}</math> L/D = 2.5</p> <p>J006 J094 -</p>	<input checked="" type="checkbox"/>	<input checked="" type="checkbox"/>

# TUNGSIX-DRILL



## Indexable drill

6 cornered insert with high performance and high economical solution

### Double-sided insert with 6-cutting edges

TungSixDrill is the first indexable drill in the world to adapt double-sided inserts with 6-cutting edges, reducing the insert consumption for our customers.

### One insert type for both the central and peripheral pockets

One side has the central edge and other side has the peripheral edge.

### Low cutting force even with double sided insert

The cutting forces are almost equal to competitors positive single sided inserts, especially at higher feed rates, thus complementing higher productivity.

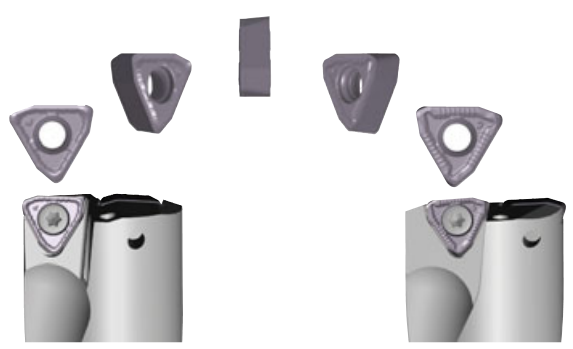
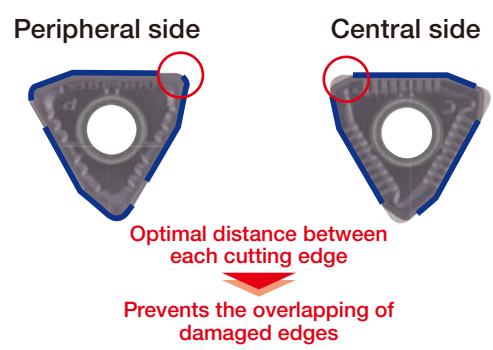

Reference pages: [J071 - J079](#)



# TUNGSIK-DRILL

## TDSU-F L/D=2

Indexable drill, L/D = 2, flat shank

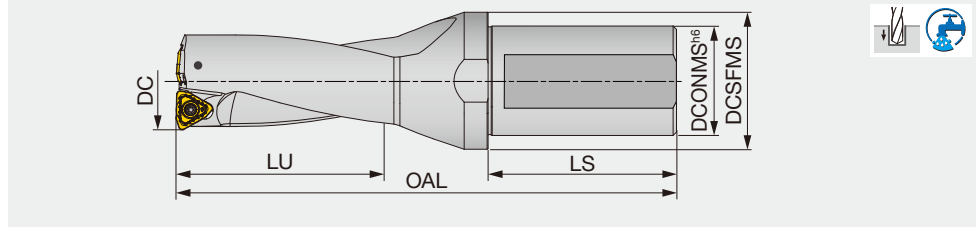

Inch	DC	DCONMS	DCSFMS	LU	LS	OAL	Max. offset** (radial)	WT(lb)	Insert
TDSU-0750FS-02***	0.750	1.000	1.457	1.531	2.280	4.897	0.004	0.800	WWMU05X205R-D*
TDSU0812F-2	0.812	1.000	1.457	1.657	2.205	4.697	0.031	0.770	WWMU05X205R-D*
TDSU0875F-2	0.875	1.000	1.457	1.782	2.205	4.862	0.020	0.820	WWMU05X205R-D*
TDSU0937F-2	0.937	1.000	1.457	1.911	2.205	5.028	0.047	0.860	WWMU060306R-D*
TDSU1000F-2	1.000	1.000	1.457	2.035	2.205	5.197	0.026	0.920	WWMU060306R-D*
TDSU1062F-2	1.062	1.250	1.575	2.161	2.342	5.500	0.012	1.320	WWMU060306R-D*

\*\* For offsetting on lathe \*\*\* Drill with side port

### SPARE PARTS

Designation	Clamping screw	Wrench
TDSU-0750FS-02	CSPB-2.2	IP-7D
TDSU0812... - TDSU0875...	CSPB-2.2	IP-7D
TDSU0937... - TDSU1062...	CSPB-2.5	IP-8D

Tool diameter (in)	Tool diameter tolerance (in)	Hole diameter tolerance (in)*
ø0.750" - ø1.062"	+ 0.008" / 0	+ 0.014" / 0

\*Just for reference

Recommended clamping torque:  
CSPB-2.2 = 0.74 lb-ft, CSPB-2.5 = 0.96 lb-ft

## TDSU-F L/D=3

Indexable drill, L/D = 3, flat shank

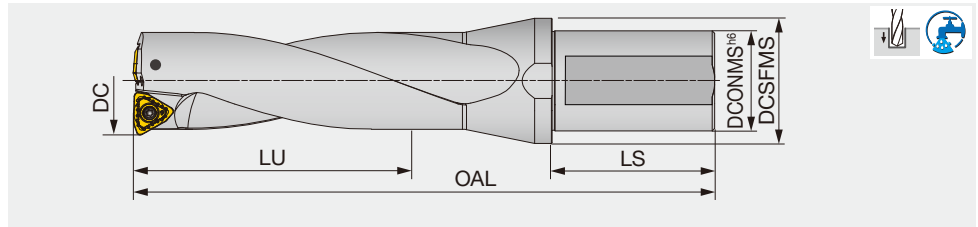

Inch	DC	DCONMS	DCSFMS	LU	LS	OAL	Max. offset** (radial)	WT(lb)	Insert
TDSU-0750FS-03***	0.750	1.000	1.457	2.281	2.280	5.653	0.004	0.840	WWMU05X205R-D*
TDSU0812F-3	0.812	1.000	1.457	2.470	2.205	5.547	0.031	0.840	WWMU05X205R-D*
TDSU0875F-3	0.875	1.000	1.457	2.657	2.205	5.697	0.020	0.870	WWMU05X205R-D*
TDSU0937F-3	0.937	1.000	1.457	2.848	2.205	5.929	0.047	0.930	WWMU060306R-D*
TDSU1000F-3	1.000	1.000	1.457	3.035	2.205	6.157	0.026	1.010	WWMU060306R-D*
TDSU1062F-3	1.062	1.250	1.575	3.221	2.342	6.524	0.012	1.430	WWMU060306R-D*

\*\* For offsetting on lathe \*\*\* Drill with side port

### SPARE PARTS

Designation	Clamping screw	Wrench
TDSU-0750FS-03	CSPB-2.2	IP-7D
TDSU0812... - TDSU0875...	CSPB-2.2	IP-7D
TDSU0937... - TDSU1062...	CSPB-2.5	IP-8D

Tool diameter (in)	Tool diameter tolerance (in)	Hole diameter tolerance (in)*
ø0.750" - ø1.062"	+ 0.008" / 0	+ 0.014" / 0

\*Just for reference

Recommended clamping torque:  
CSPB-2.2 = 0.74 lb-ft, CSPB-2.5 = 0.96 lb-ft

Reference pages: Inserts, Standard cutting conditions → J076 - J077



# TUNGSIX-DRILL

TDS-F L/D=2

Indexable drill, L/D = 2, flat shank

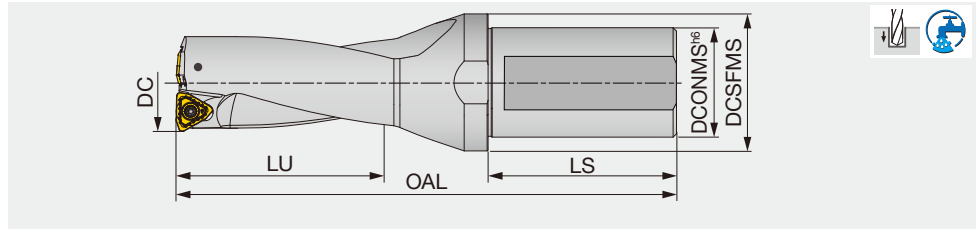

Metric	DC	DCONMS	DCSFMS	LU	LS	OAL	Max. offset (radial)	WT(kg)	Insert
TDS200F25-2	20	25	32	40.8	54	115.8	1	0.3	WWMU05X205R-D*
TDS205F25-2	20.5	25	32	41.8	54	117.3	0.9	0.3	WWMU05X205R-D*
TDS210F25-2	21	25	32	42.8	54	118.8	0.8	0.3	WWMU05X205R-D*
TDS215F25-2	21.5	25	32	43.8	54	119.8	0.6	0.3	WWMU05X205R-D*
TDS220F25-2	22	25	32	44.8	54	120.8	0.5	0.3	WWMU05X205R-D*
TDS225F25-2	22.5	25	37	45.8	54	122.3	0.4	0.3	WWMU05X205R-D*
TDS230F25-2	23	25	37	46.8	54	123.8	0.3	0.4	WWMU05X205R-D*
TDS235F25-2	23.5	25	37	47.8	54	124.8	0.2	0.4	WWMU05X205R-D*
TDS240F25-2	24	25	37	48.9	54	125.9	1.2	0.4	WWMU060306R-D*
TDS245F25-2	24.5	25	37	49.9	54	127.4	1	0.4	WWMU060306R-D*
TDS250F25-2	25	25	37	50.9	54	128.9	0.8	0.4	WWMU060306R-D*
TDS255F25-2	25.5	25	37	51.9	54	130.4	0.6	0.4	WWMU060306R-D*
TDS260F25-2	26	25	37	52.9	54	131.9	0.5	0.4	WWMU060306R-D*
TDS270F32-2	27	32	40	54.9	59	138.9	0.3	0.6	WWMU060306R-D*
TDS280F32-2	28	32	40	57.1	59	142.1	1.3	0.6	WWMU08X408R-D*
TDS290F32-2	29	32	40	59.1	59	144.1	1.1	0.7	WWMU08X408R-D*
TDS300F32-2	30	32	40	61.1	59	147.1	0.8	0.7	WWMU08X408R-D*
TDS310F32-2	31	32	40	63.1	59	150.1	0.5	0.7	WWMU08X408R-D*
TDS320F32-2	32	32	40	65.1	59	152.1	0.2	0.8	WWMU08X408R-D*
TDS330F40-2	33	40	50	67.3	69	165.3	1.7	1.2	WWMU09X510R-D*
TDS340F40-2	34	40	50	69.3	69	168.3	1.4	1.2	WWMU09X510R-D*
TDS350F40-2	35	40	50	71.3	69	171.3	1.2	1.2	WWMU09X510R-D*
TDS360F40-2	36	40	50	73.3	69	174.3	0.9	1.3	WWMU09X510R-D*
TDS370F40-2	37	40	50	75.3	69	175.3	0.7	1.3	WWMU09X510R-D*
TDS380F40-2	38	40	50	77.3	69	178.3	0.4	1.3	WWMU09X510R-D*
TDS390F40-2	39	40	50	79.6	69	180.6	2.2	1.4	WWMU11X512R-D*
TDS400F40-2	40	40	50	81.6	69	183.6	1.9	1.4	WWMU11X512R-D*
TDS410F40-2	41	40	50	83.6	69	187.6	1.7	1.5	WWMU11X512R-D*
TDS420F40-2	42	40	55	85.6	69	189.6	1.5	1.6	WWMU11X512R-D*
TDS430F40-2	43	40	55	87.6	69	192.6	1.3	1.6	WWMU11X512R-D*
TDS440F40-2	44	40	55	89.6	69	194.6	1	1.7	WWMU11X512R-D*
TDS450F40-2	45	40	55	91.6	69	197.6	0.7	1.7	WWMU11X512R-D*
TDS460F40-2	46	40	55	93.6	69	200.6	0.4	1.8	WWMU11X512R-D*
TDS470F40-2	47	40	55	95.8	69	202.8	2.6	1.9	WWMU13X512R-D*
TDS480F40-2	48	40	55	97.8	69	205.8	2.4	1.9	WWMU13X512R-D*
TDS490F40-2	49	40	55	99.8	69	207.8	2.2	1.9	WWMU13X512R-D*
TDS500F40-2	50	40	55	101.8	69	210.8	2	2	WWMU13X512R-D*
TDS510F40-2	51	40	55	103.8	69	214.8	1.7	2.1	WWMU13X512R-D*
TDS520F40-2	52	40	55	105.8	69	216.8	1.5	2.2	WWMU13X512R-D*
TDS530F40-2	53	40	55	107.8	69	219.8	1.3	2.3	WWMU13X512R-D*
TDS540F40-2	54	40	55	109.8	69	221.8	1	2.4	WWMU13X512R-D*

## SPARE PARTS

Designation	Clamping screw	Wrench
TDS200... - TDS235...	CSPB-2.2	IP-7D
TDS240... - TDS270...	CSPB-2.5	IP-8D
TDS280... - TDS320...	CSTB-3	T-9D
TDS330... - TDS380...	CSTB-4	T-15D
TDS390... - TDS540...	CSTB-5	T-20D

Tool diameter (mm)	Tool diameter tolerance (mm)	Hole diameter tolerance (mm)*
ø20 - ø27	+ 0.2 / 0	+ 0.25 / 0
ø28 - ø54	+ 0.2 / 0	+ 0.3 / 0

\*Just for reference

Recommended clamping torque: CSPB-2.2 = 1 N·m, CSPB-2.5 = 1.3 N·m, CSTB-3 = 2.3 N·m, CSTB-4 = 3.5 N·m, CSTB-5 = 5 N·m

Reference pages: Inserts, Standard cutting conditions → **J076 - J077**

# TDS-F L/D=3

Indexable drill, L/D = 3, flat shank

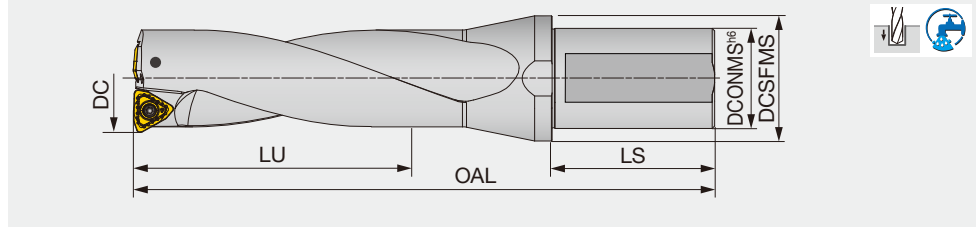

Metric	DC	DCONMS	DCSFMS	LU	LS	OAL	Max. offset (radial)	WT(kg)	Insert
TDS200F25-3	20	25	32	60.8	54	135.8	1	0.3	WWMU05X205R-D*
TDS205F25-3	20.5	25	32	62.3	54	136.8	0.9	0.3	WWMU05X205R-D*
TDS209F25-3 (1)	20.9	25	32	63.5	54	138.8	0.8	0.3	WWMU05X205R-D*
TDS210F25-3	21	25	32	63.8	54	138.8	0.8	0.4	WWMU05X205R-D*
TDS215F25-3	21.5	25	32	65.3	54	140.8	0.6	0.4	WWMU05X205R-D*
TDS220F25-3	22	25	32	66.8	54	141.8	0.5	0.4	WWMU05X205R-D*
TDSU0875F25-3 (2)	22.2	25	32	66.8	54	141.8	0.4	0.4	WWMU05X205R-D*
TDS225F25-3	22.5	25	37	68.3	54	144.8	0.4	0.4	WWMU05X205R-D*
TDS230F25-3	23	25	37	69.8	54	145.8	0.3	0.4	WWMU05X205R-D*
TDS235F25-3	23.5	25	37	71.3	54	147.8	0.2	0.4	WWMU05X205R-D*
TDS239F25-3 (1)	23.9	25	37	72.6	54	149.9	1.2	0.4	WWMU060306R-D*
TDS240F25-3	24	25	37	72.9	54	149.9	1.2	0.4	WWMU060306R-D*
TDS245F25-3	24.5	25	37	74.4	54	151.9	1	0.5	WWMU060306R-D*
TDS250F25-3	25	25	37	75.9	54	153.9	0.8	0.5	WWMU060306R-D*
TDS255F25-3	25.5	25	37	77.4	54	154.9	0.6	0.5	WWMU060306R-D*
TDS260F25-3 (1)	26	25	37	78.9	54	156.9	0.5	0.5	WWMU060306R-D*
TDS264F32-3	26.4	32	40	80.1	59	163.4	0.4	0.6	WWMU060306R-D*
TDS265F32-3	26.5	32	40	80.4	59	163.4	0.4	0.6	WWMU060306R-D*
TDS270F32-3	27	32	40	81.9	59	164.9	0.3	0.6	WWMU060306R-D*
TDS275F32-3	27.5	32	40	83.1	59	168.1	0	0.6	WWMU08X408R-D*
TDS280F32-3	28	32	40	85.1	59	169.1	1.3	0.7	WWMU08X408R-D*
TDS285F32-3	28.5	32	40	86.1	59	171.1	1.1	0.7	WWMU08X408R-D*
TDSU1125F32-3 (2)	28.6	32	40	87.1	59	172.1	1.1	0.7	WWMU08X408R-D*
TDS290F32-3	29	32	40	88.1	59	172.1	1.1	0.7	WWMU08X408R-D*
TDS295F32-3	29.5	32	40	89.1	59	176.1	0.8	0.7	WWMU08X408R-D*
TDS300F32-3	30	32	40	91.1	59	177.1	0.8	0.8	WWMU08X408R-D*
TDS305F32-3	30.5	32	40	92.1	59	181.1	0.5	0.8	WWMU08X408R-D*
TDS310F32-3	31	32	40	94.1	59	181.1	0.5	0.8	WWMU08X408R-D*
TDSU1250F32-3 (2)	31.8	32	40	96.1	59	184.1	0.2	0.8	WWMU08X408R-D*
TDS320F32-3	32	32	40	97.1	59	184.1	0.2	0.9	WWMU08X408R-D*
TDS330F40-3	33	40	50	100.3	69	198.3	1.7	1.3	WWMU09X510R-D*
TDS340F40-3	34	40	50	103.3	69	201.3	1.4	1.3	WWMU09X510R-D*
TDS350F40-3	35	40	50	106.3	69	205.3	1.2	1.3	WWMU09X510R-D*
TDS360F40-3	36	40	50	109.3	69	209.3	0.9	1.4	WWMU09X510R-D*
TDS370F40-3	37	40	50	112.3	69	212.3	0.7	1.4	WWMU09X510R-D*
TDS380F40-3	38	40	50	115.3	69	216.3	0.4	1.5	WWMU09X510R-D*
TDS390F40-3	39	40	50	118.6	69	219.6	2.2	1.6	WWMU11X512R-D*
TDS400F40-3	40	40	50	121.6	69	223.6	1.9	1.6	WWMU11X512R-D*
TDS410F40-3	41	40	50	124.6	69	227.6	1.7	1.7	WWMU11X512R-D*
TDS420F40-3	42	40	55	127.6	69	230.6	1.5	1.8	WWMU11X512R-D*
TDS430F40-3	43	40	55	130.6	69	234.6	1.3	1.8	WWMU11X512R-D*
TDS440F40-3	44	40	55	133.6	69	237.6	1	1.9	WWMU11X512R-D*
TDS450F40-3	45	40	55	136.6	69	242.6	0.7	2	WWMU11X512R-D*
TDS460F40-3	46	40	55	139.6	69	246.6	0.4	2.1	WWMU11X512R-D*
TDS470F40-3	47	40	55	142.8	69	249.8	2.6	2.2	WWMU13X512R-D*
TDS480F40-3	48	40	55	145.8	69	253.8	2.4	2.3	WWMU13X512R-D*
TDS490F40-3	49	40	55	148.8	69	256.8	2.2	2.3	WWMU13X512R-D*
TDS500F40-3	50	40	55	151.8	69	260.8	2	2.4	WWMU13X512R-D*
TDS510F40-3	51	40	55	154.8	69	264.8	1.7	2.5	WWMU13X512R-D*
TDS520F40-3	52	40	55	157.8	69	267.8	1.5	2.6	WWMU13X512R-D*
TDS530F40-3	53	40	55	160.8	69	271.8	1.3	2.7	WWMU13X512R-D*
TDS540F40-3	54	40	55	163.8	69	274.8	1	2.9	WWMU13X512R-D*

## SPARE PARTS

Designation	Clamping screw	Wrench
TDS200... - TDS235...	CSPB-2.2	IP-7D
TDS240... - TDS270...	CSPB-2.5	IP-8D
TDS280... - TDS320...	CSTB-3	T-9D
TDS330... - TDS380...	CSTB-4	T-15D
TDS390... - TDS540...	CSTB-5	T-20D

(1) For pre thread hole: DC = 20.9 mm: M24x3, DC = 23.9 mm: M27x3, DC = 26.4 mm: M30x3.5  
 (2) For inch size: DC: 22.2 mm = 0.87", DC: 28.6 mm = 1.125", DC: 31.8 mm = 1.250"

\*Just for reference

Reference pages: Inserts, Standard cutting conditions →

**J076 - J077**

Recommended clamping torque: CSPB-2.2 = 1 N·m, CSPB-2.5 = 1.3 N·m, CSTB-3 = 2.3 N·m, CSTB-4 = 3.5 N·m, CSTB-5 = 5 N·m

Grade  
Insert  
Ext. Toolholder  
Int. Toolholder  
Threading  
Grooving  
Miniature tool  
Milling cutter  
Endmill  
Drilling tool  
Tooling System  
User's Guide  
Index



# TUNGSIX-DRILL

TDSU-F L/D=4

Indexable drill, L/D = 4, flat shank

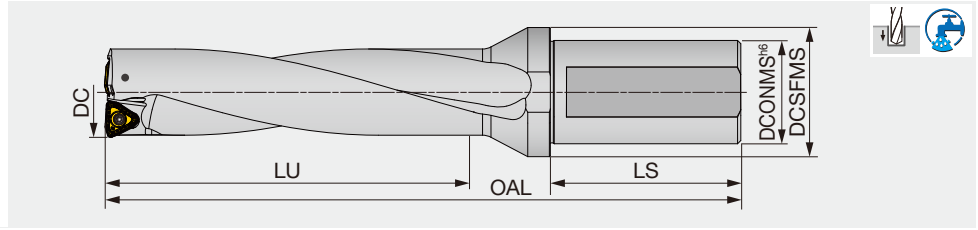

Inch	DC	DCONMS	DCSFMS	LU	LS	OAL	Max. offset** (radial)	WT(lb)	Insert
TDSU-0750FS-04***	0.750	1.000	1.457	3.031	2.280	6.401	0.004	0.880	WWMU05X205R-D*
TDSU0812F-4	0.812	1.000	1.457	3.283	2.343	6.457	0.031	0.950	WWMU05X205R-D*
TDSU0875F-4	0.875	1.000	1.457	3.531	2.343	6.708	0.016	1.010	WWMU05X205R-D*
TDSU0937F-4	0.938	1.000	1.457	3.787	2.343	7.003	0.047	1.100	WWMU060306R-D*
TDSU1000F-4	1.000	1.000	1.457	4.035	2.343	7.294	0.024	1.220	WWMU060306R-D*
TDSU1062F-4	1.063	1.250	1.575	4.287	2.343	7.585	0.012	1.640	WWMU060306R-D*
TDSU1125F-4	1.125	1.250	1.575	4.543	2.343	7.894	0.043	1.700	WWMU08X408R-D*
TDSU1187F-4	1.187	1.250	1.575	4.791	2.343	8.174	0.019	1.820	WWMU08X408R-D*
TDSU1250F-4	1.250	1.250	1.575	5.043	2.343	8.469	0.008	1.970	WWMU08X408R-D*
TDSU1312F-4	1.312	1.500	1.969	5.299	2.736	9.161	0.055	2.850	WWMU09X510R-D*
TDSU1375F-4	1.375	1.500	1.969	5.551	2.736	9.450	0.047	2.950	WWMU09X510R-D*
TDSU1437F-4	1.437	1.500	1.969	5.799	2.736	9.742	0.027	3.190	WWMU09X510R-D*
TDSU1500F-4	1.500	1.500	1.969	6.051	2.736	10.033	0.015	3.370	WWMU09X510R-D*
TDSU1562F-4	1.562	1.500	1.969	6.307	2.736	10.352	0.074	3.570	WWMU11X512R-D*
TDSU1625F-4	1.625	1.500	2.165	6.559	2.736	10.641	0.059	3.860	WWMU11X512R-D*
TDSU1687F-4	1.687	1.500	2.165	6.807	2.736	10.932	0.051	4.160	WWMU11X512R-D*
TDSU1750F-4	1.750	1.500	2.165	7.059	2.736	11.223	0.027	4.420	WWMU11X512R-D*
TDSU1812F-4	1.812	1.500	2.165	7.307	2.736	11.517	0.015	4.700	WWMU11X512R-D*
TDSU1875F-4	1.875	1.500	2.165	7.571	2.736	11.813	0.094	5.080	WWMU13X512R-D*
TDSU1937F-4	1.937	1.500	2.165	7.819	2.736	12.105	0.078	5.300	WWMU13X512R-D*
TDSU2000F-4	2.000	1.500	2.165	8.071	2.736	12.396	0.067	5.750	WWMU13X512R-D*

\*\* For offsetting on lathe \*\*\* Drill with side port

## SPARE PARTS

Designation	Clamping screw	Wrench
TDSU-0750FS-04	CSPB-2.2	IP-7D
TDSU0812... - TDSU0875...	CSPB-2.2	IP-7D
TDSU0937... - TDSU1062...	CSPB-2.5	IP-8D
TDSU1125... - TDSU1250...	CSTB-3	T-9D
TDSU1312... - TDSU1500...	CSTB-4	T-15D
TDSU1562... - TDSU2000...	CSTB-5	T-20D

Tool diameter (in)	Tool diameter tolerance (in)	Hole diameter tolerance (in)*
ø0.750" - ø2.000"	+ 0.008" / 0	+ 0.014" / 0

\*Just for reference

Recommended clamping torque: CSPB-2.2 = 0.74 lb-ft, CSPB-2.5 = 0.96 lb-ft, CSTB-3 = 1.70 lb-ft, CSTB-4 = 2.58 lb-ft, CSTB-5 = 3.69 lb-ft

Reference pages: Inserts, Standard cutting conditions → [J076](#) - [J077](#)

# TDS-F L/D=4

Indexable drill, L/D = 4, flat shank

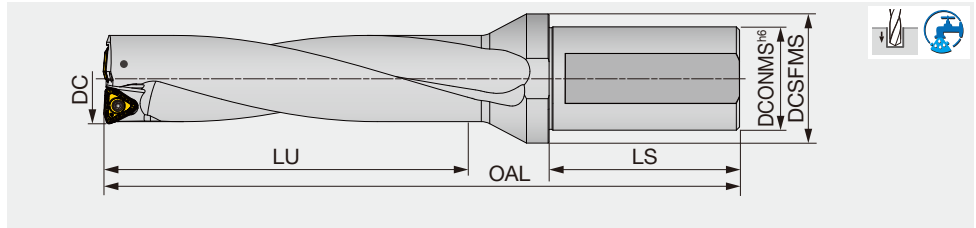

Metric	DC	DCONMS	DCSFMS	LU	LS	OAL	Max. offset (radial)	WT(kg)	Insert
TDS200F25-4	20	25	32	80.8	54	155.8	1	0.4	WWMU05X205R-D*
TDS205F25-4	20.5	25	32	82.8	54	157.8	0.9	0.4	WWMU05X205R-D*
TDS210F25-4	21	25	32	84.8	54	159.8	0.8	0.4	WWMU05X205R-D*
TDS215F25-4	21.5	25	32	86.8	54	161.8	0.6	0.4	WWMU05X205R-D*
TDS220F25-4	22	25	32	88.8	54	163.8	0.5	0.4	WWMU05X205R-D*
TDS225F25-4	22.5	25	37	90.8	54	166.3	0.4	0.4	WWMU05X205R-D*
TDS230F25-4	23	25	37	92.8	54	168.8	0.3	0.4	WWMU05X205R-D*
TDS235F25-4	23.5	25	37	94.8	54	171.3	0.2	0.5	WWMU05X205R-D*
TDS240F25-4	24	25	37	96.9	54	173.9	1.2	0.5	WWMU060306R-D*
TDS245F25-4	24.5	25	37	98.9	54	176.4	1	0.5	WWMU060306R-D*
TDS250F25-4	25	25	37	100.9	54	178.9	0.8	0.5	WWMU060306R-D*
TDS255F25-4	25.5	25	37	102.9	54	180.9	0.6	0.6	WWMU060306R-D*
TDS260F25-4	26	25	37	104.9	54	182.9	0.5	0.5	WWMU060306R-D*
TDS270F32-4	27	32	40	108.9	59	191.9	0.3	0.7	WWMU060306R-D*
TDS280F32-4	28	32	40	113.1	59	197.1	1.3	0.8	WWMU08X408R-D*
TDS290F32-4	29	32	40	117.1	59	201.1	1.1	0.8	WWMU08X408R-D*
TDS300F32-4	30	32	40	121.1	59	207.1	0.8	0.9	WWMU08X408R-D*
TDS310F32-4	31	32	40	125.1	59	212.1	0.5	0.9	WWMU08X408R-D*
TDS320F32-4	32	32	40	129.1	59	216.1	0.2	1	WWMU08X408R-D*
TDS330F40-4	33	40	50	133.3	69	231.3	1.7	1.4	WWMU09X510R-D*
TDS340F40-4	34	40	50	137.3	69	235.3	1.4	1.4	WWMU09X510R-D*
TDS350F40-4	35	40	50	141.3	69	240.3	1.2	1.4	WWMU09X510R-D*
TDS360F40-4	36	40	50	145.3	69	245.3	0.9	1.5	WWMU09X510R-D*
TDS370F40-4	37	40	50	149.3	69	249.3	0.7	1.5	WWMU09X510R-D*
TDS380F40-4	38	40	50	153.3	69	254.3	0.4	1.7	WWMU09X510R-D*
TDS390F40-4	39	40	50	157.5	69	259	2.2	1.8	WWMU11X512R-D*
TDS400F40-4	40	40	50	161.5	69	264	1.9	1.8	WWMU11X512R-D*
TDS410F40-4	41	40	50	165.5	69	269	1.7	1.9	WWMU11X512R-D*
TDS420F40-4	42	40	55	169.5	69	273	1.5	2	WWMU11X512R-D*
TDS430F40-4	43	40	55	173.5	69	278	1.3	2	WWMU11X512R-D*
TDS440F40-4	44	40	55	177.5	69	282	1	2.1	WWMU11X512R-D*
TDS450F40-4	45	40	55	181.5	69	288	0.7	2.3	WWMU11X512R-D*
TDS460F40-4	46	40	55	185.5	69	293	0.4	2.4	WWMU11X512R-D*
TDS470F40-4	47	40	55	189.8	69	297.3	2.6	2.5	WWMU13X512R-D*
TDS480F40-4	48	40	55	193.8	69	302.3	2.4	2.7	WWMU13X512R-D*
TDS490F40-4	49	40	55	197.8	69	306.3	2.2	2.7	WWMU13X512R-D*
TDS500F40-4	50	40	55	201.8	69	311.3	2	2.8	WWMU13X512R-D*
TDS510F40-4	51	40	55	205.8	69	316.3	1.7	2.9	WWMU13X512R-D*
TDS520F40-4	52	40	55	209.8	69	320.3	1.5	3	WWMU13X512R-D*
TDS530F40-4	53	40	55	213.8	69	325.3	1.3	3.1	WWMU13X512R-D*
TDS540F40-4	54	40	55	217.8	69	329.3	1	3.4	WWMU13X512R-D*

## SPARE PARTS

Designation	Clamping screw	Wrench
TDS200... - TDS235...	CSPB-2.2	IP-7D
TDS240... - TDS270...	CSPB-2.5	IP-8D
TDS280... - TDS320...	CSTB-3	T-9D
TDS330... - TDS380...	CSTB-4	T-15D
TDS390... - TDS540...	CSTB-5	T-20D

Tool diameter (mm)	Tool diameter tolerance (mm)	Hole diameter tolerance (mm)*
ø20 - ø27	+ 0.2 / 0	+ 0.3 / 0
ø28 - ø54	+ 0.2 / 0	+ 0.35 / 0

\*Just for reference

Recommended clamping torque: CSPB-2.2 = 1 N·m, CSPB-2.5 = 1.3 N·m, CSTB-3 = 2.3 N·m, CSTB-4 = 3.5 N·m, CSTB-5 = 5 N·m

Reference pages: Inserts, Standard cutting conditions → **J076 - J077**



# STANDARD CUTTING CONDITIONS



ISO	Workpiece materials	Hardness	Priority	Chip breakers	Grade	Cutting speed Vc (sfm)
<b>P</b>	Low carbon steels (C < 0.3) 1018, 1020, 1026, etc.	- 200 HB	First choice	DS	AH6030	525 - 820
			Wear resistance	DJ	AH9030	525 - 1050
	Carbon steels (C > 0.3) 1045, 1055, etc.	- 300 HB	First choice	DJ	AH9030	262 - 820
			Fracture resistance	DJ	AH3135	262 - 820
	Low alloy steels 5120, etc.	- 200 HB	First choice	DS	AH6030	525 - 820
			Wear resistance	DJ	AH9030	525 - 820
Alloy steels 4140, 8620, etc.	- 300 HB	First choice	DJ	AH9030	262 - 656	
		Fracture resistance	DJ	AH3135	262 - 656	
<b>M</b>	Stainless steels (Austenitic) 304SS, 316SS, etc.	- 200 HB	First choice	DS	AH6030	328 - 656
			Fracture resistance	DJ	AH3135	328 - 656
	Stainless steels (Martensitic and ferritic) 430SS, 416SS, etc.	- 200 HB	First choice	DS	AH6030	328 - 656
			Fracture resistance	DJ	AH3135	328 - 656
	Stainless steels (Precipitation hardening) 17-4 PH, etc.	-	First choice	DS	AH6030	262 - 394
			Fracture resistance	DJ	AH3135	262 - 394
<b>K</b>	Gray cast irons Class 25, Class 30, etc.	150 - 250 HB	First choice	DJ	AH9030	262 - 820
			Fracture resistance	DJ	AH3135	262 - 656
	Ductile cast irons 60-40-18, 60-55-06, etc.	150 - 250 HB	First choice	DJ	AH9030	262 - 656
			Fracture resistance	DJ	AH3135	262 - 492
<b>N</b>	Aluminum alloy	-	First choice	DS	AH6030	656 - 1312
<b>S</b>	Heat resistant alloy Inconel718, etc	- 40 HRC	First choice	DS	AH6030	66 - 197
			Fracture resistance	DJ	AH3135	66 - 197
	Titanium alloys Ti-6Al-4V, etc.	- 40 HRC	First choice	DS	AH6030	131 - 394
			Fracture resistance	DJ	AH3135	131 - 394
<b>H</b>	Hardened steel Over 40HRC	- 50 HRC	First choice	DJ	AH9030	164 - 328
			Fracture resistance	DJ	AH3135	131 - 262

## INSERT

DJ

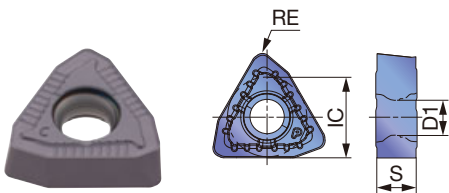

<b>P</b> Steel	☆	★							
<b>M</b> Stainless	★	☆							
<b>K</b> Cast iron	☆	★							
<b>N</b> Non-ferrous	☆	☆							
<b>S</b> Superalloys	★	☆							
<b>H</b> Hard materials	★	☆							

★ : First choice  
☆ : Second choice

Designation	IC (in)	S (in)	Coated		D1 (in)	RE (in)	DCN (in)	DCX (in)
			AH3135	AH9030				
WWMU05X205R-DJ	0.228	0.094	●	●	0.098	0.020	0.787	0.925
WWMU060306R-DJ	0.264	0.114	●	●	0.118	0.024	0.941	1.063
WWMU08X408R-DJ	0.315	0.154	●	●	0.134	0.031	1.083	1.260
WWMU09X510R-DJ	0.382	0.193	●	●	0.173	0.039	1.299	1.496
WWMU11X512R-DJ	0.445	0.224	●	●	0.217	0.047	1.535	1.811
WWMU13X512R-DJ	0.512	0.224	●	●	0.217	0.047	1.850	2.126

● : Line up



Feed: *f* (ipr)

L/D = 2, 3		L/D = 4			
DC (in)		DC (in)			
ø0.787" - ø1.083"	ø1.102" - ø1.496"	ø1.535" - ø2.126"	ø0.787" - ø1.063"	ø1.102" - ø1.496"	ø1.353" - ø2.126"
0.0016 - 0.0039	0.0016 - 0.0039	0.0016 - 0.0039	0.0016 - 0.0039	0.0016 - 0.0039	0.0016 - 0.0039
0.0016 - 0.0039	0.0016 - 0.0039	0.0016 - 0.0039	0.0016 - 0.0039	0.0016 - 0.0039	0.0016 - 0.0039
0.0024 - 0.0059	0.0024 - 0.0063	0.0031 - 0.0071	0.0024 - 0.0059	0.0024 - 0.0059	0.0031 - 0.0067
0.0016 - 0.0047	0.0016 - 0.0051	0.0016 - 0.0059	0.0016 - 0.0047	0.0016 - 0.0051	0.0016 - 0.0059
0.0016 - 0.0047	0.0016 - 0.0047	0.0016 - 0.0047	0.0016 - 0.0047	0.0016 - 0.0047	0.0016 - 0.0047
0.0024 - 0.0047	0.0024 - 0.0055	0.0024 - 0.0055	0.0024 - 0.0047	0.0024 - 0.0055	0.0024 - 0.0055
0.0024 - 0.0059	0.0024 - 0.0063	0.0031 - 0.0071	0.0024 - 0.0059	0.0024 - 0.0059	0.0031 - 0.0067
0.0016 - 0.0047	0.0016 - 0.0051	0.0016 - 0.0059	0.0016 - 0.0047	0.0016 - 0.0051	0.0016 - 0.0059
0.0016 - 0.0039	0.0016 - 0.0047	0.0016 - 0.0047	0.0016 - 0.0047	0.0016 - 0.0047	0.0016 - 0.0047
0.0016 - 0.0039	0.0016 - 0.0047	0.0016 - 0.0047	0.0016 - 0.0047	0.0016 - 0.0047	0.0016 - 0.0047
0.0016 - 0.0039	0.0016 - 0.0047	0.0016 - 0.0047	0.0016 - 0.0047	0.0016 - 0.0047	0.0016 - 0.0047
0.0016 - 0.0039	0.0016 - 0.0039	0.0016 - 0.0039	0.0016 - 0.0039	0.0016 - 0.0039	0.0016 - 0.0039
0.0016 - 0.0039	0.0016 - 0.0039	0.0016 - 0.0039	0.0016 - 0.0039	0.0016 - 0.0039	0.0016 - 0.0039
0.0024 - 0.0059	0.0024 - 0.0071	0.0031 - 0.0079	0.0024 - 0.0059	0.0024 - 0.0063	0.0031 - 0.0071
0.0024 - 0.0051	0.0024 - 0.0063	0.0031 - 0.0071	0.0024 - 0.0051	0.0024 - 0.0063	0.0031 - 0.0071
0.0024 - 0.0059	0.0024 - 0.0071	0.0031 - 0.0079	0.0024 - 0.0059	0.0024 - 0.0063	0.0031 - 0.0071
0.0024 - 0.0051	0.0024 - 0.0063	0.0031 - 0.0071	0.0024 - 0.0051	0.0024 - 0.0063	0.0031 - 0.0071
0.0039 - 0.0071	0.0039 - 0.0079	0.0039 - 0.0098	0.0039 - 0.0071	0.0039 - 0.0079	0.0039 - 0.0079
0.0039 - 0.0071	0.0039 - 0.0079	0.0039 - 0.0098	0.0039 - 0.0071	0.0039 - 0.0079	0.0039 - 0.0079
0.0016 - 0.0031	0.0016 - 0.0031	0.0016 - 0.0039	0.0016 - 0.0039	0.0016 - 0.0039	0.0016 - 0.0039
0.0016 - 0.0031	0.0016 - 0.0031	0.0016 - 0.0039	0.0016 - 0.0039	0.0016 - 0.0039	0.0016 - 0.0039
0.0024 - 0.0039	0.0024 - 0.0047	0.0024 - 0.0055	0.0024 - 0.0055	0.0024 - 0.0055	0.0024 - 0.0055
0.0024 - 0.0039	0.0024 - 0.0047	0.0024 - 0.0055	0.0024 - 0.0055	0.0024 - 0.0055	0.0024 - 0.0055
0.0016 - 0.0031	0.0016 - 0.0031	0.0016 - 0.0039	0.0016 - 0.0031	0.0016 - 0.0031	0.0016 - 0.0031
0.0016 - 0.0031	0.0016 - 0.0031	0.0016 - 0.0039	0.0016 - 0.0031	0.0016 - 0.0031	0.0016 - 0.0031

DS

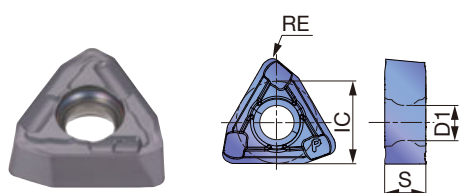

P	Steel	★							
M	Stainless	★							
K	Cast iron								
N	Non-ferrous	★							
S	Superalloys	★							
H	Hard materials								

★ : First choice  
☆ : Second choice





Designation	IC (in)	S (in)	Coated								D1 (in)	RE (in)	DCN (in)	DCX (in)
			AH6030											
WWMU05X205R-DS	0.228	0.094	●								0.098	0.020	0.787	0.925
WWMU060306R-DS	0.264	0.114	●								0.118	0.024	0.941	1.063
WWMU08X408R-DS	0.315	0.154	●								0.134	0.031	1.083	1.260
WWMU09X510R-DS	0.382	0.193	●								0.173	0.039	1.299	1.496
WWMU11X512R-DS	0.445	0.224	●								0.217	0.047	1.535	1.811
WWMU13X512R-DS	0.512	0.224	●								0.217	0.047	1.850	2.126

● : Line up

Grade  
A  
B  
C  
D  
E  
F  
G  
H  
I  
J  
K  
L  
M  
Insert  
Ext. Toolholder  
Int. Toolholder  
Threading  
Grooving  
Miniature tool  
Milling cutter  
Endmill  
Drilling tool  
Tooling System  
User's Guide  
Index

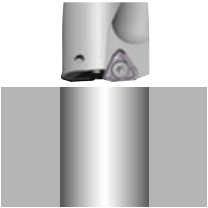
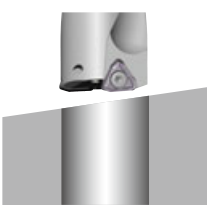
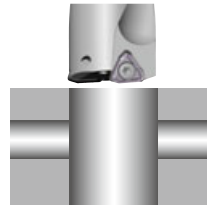
## APPLICATION RANGE

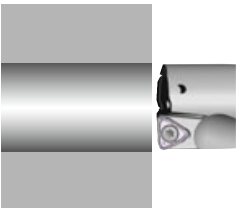
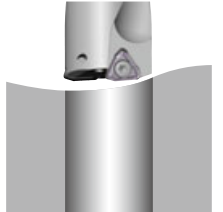
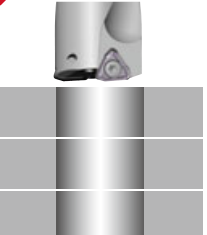
\*In case of Interrupted cutting, feed should be decreased.

Feed f (ipr)	Refer to <b>J076 - J077</b> page	0.002"	0.002"	0.002"
Application range	<b>OK</b> Plane surface 	<b>OK</b> Slant surface 	<b>OK</b> Cross hole 	<b>OK</b> Plunging 
Feed f (ipr)	0.004"	0.002"	Disapprove	Disapprove
Application range	<b>OK</b> Boring 	<b>OK</b> Round surface 	<b>X</b> Stacked plates 	<b>X</b> Back boring 

## TUNGSIX-DRILL

### TDXCF chamfering tool

Chamfering tool for TungDrillTwisted and TungSix-Drill

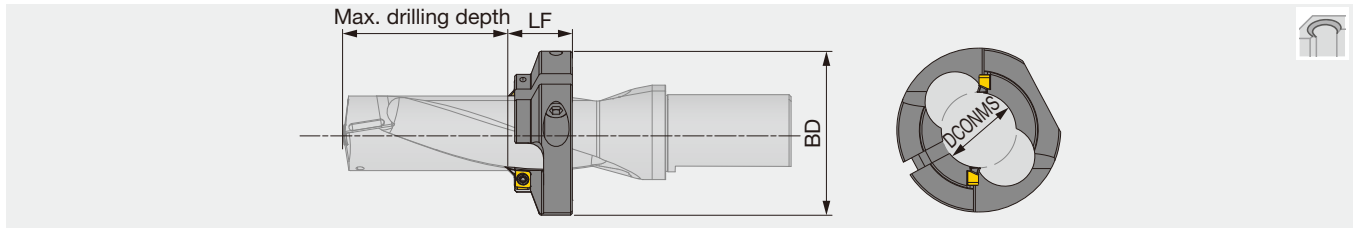

Inch	DCONMS	BD	LF	Application drill	Max. drilling depth		
					L/D = 2	L/D = 3	L/D = 4
TDXCF210L25	0.791	1.929	0.984	TDSU0812...	0.700	1.512	-
TDXCF230L25	0.870	1.929	0.984	TDSU0875...	0.825	1.700	-
TDXCF240L25	0.909	1.929	0.984	TDSU0937...	0.950	1.887	-
TDXCF260L30	0.982	2.520	1.181	TDSU1000...	0.878	1.878	-
TDXCF270L30	1.020	2.520	1.181	TDSU1062...	1.003	2.065	-
TDXCF290L30	1.098	2.520	1.181	TDSU1125...	-	-	3.486
TDXCF300L30	1.138	2.520	1.181	TDSU1187...	-	-	3.726
TDXCF320L30	1.217	2.520	1.181	TDSU1250...	-	-	3.976
TDXCF340L30	1.291	2.520	1.181	TDSU1312...	-	-	4.226
TDXCF350L30	1.331	2.520	1.181	TDSU1375...	-	-	4.476
TDXCF370L30	1.409	3.346	1.181	TDSU1437...	-	-	4.726
TDXCF380L30	1.449	3.346	1.181	TDSU1500...	-	-	4.977
TDXCF400L30	1.528	3.346	1.181	TDSU1562...	-	-	5.245
TDXCF410L30	1.567	3.346	1.181	TDSU1625...	-	-	5.496
TDXCF430L30	1.638	3.346	1.181	TDSU1687...	-	-	5.746
TDXCF450L30	1.717	3.346	1.181	TDSU1750...	-	-	5.998
TDXCF460L30	1.756	3.346	1.181	TDSU1812...	-	-	6.248
TDXCF480L30	1.835	3.346	1.181	TDSU1875...	-	-	6.496
TDXCF500L30	1.913	3.346	1.181	TDSU1937...	-	-	6.746
TDXCF510L30	1.953	3.346	1.181	TDSU2000...	-	-	6.996

### SPARE PARTS

Designation	Screw for insert	Screw for ring	Wrench for insert	Wrench for ring
TDXCF210 - 250	CSPB-4S	CM6X16	IP-15D	P-5
TDXCF260 - 540	CSPB-4S	CM8X1.25X20-A	IP-15D	P-6

Recommended clamping torque: CSPB-4S = 2.58 lb-ft

# INSERT

XHGX-45A

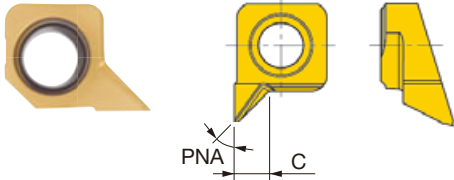

Designation	PNA	C (in)	Coated							
			GH130							
XHGX090700R-45A	45°	0.098	●							

P	Steel	★							
M	Stainless	★							
K	Cast iron	★							
N	Non-ferrous	☆							
S	Superalloys	★							
H	Hard materials	★							

★ : First choice  
☆ : Second choice

● : Line up

## Caution in mounting the chamfering tool on the drill body

- ① Place the ring on the drill body and match the positions of flutes on drill and ring. Temporarily clamp the ring with the ring screw tightened lightly.
- ② Place the inserts, and tighten the insert screw lightly.
- ③ Adjust the ring position with a presetter, height gauge, or vernier caliper, and securely tighten the ring screw, then the insert screw.



**Match the positions of flutes on drill and ring.**

(Inserts will be automatically set to the right positions.)

**The cutting edge of the insert is in the ring flute.**



**The flutes on drill and ring do not match.**

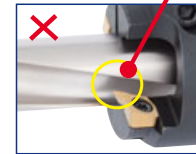

# TUNGDRILL TWISTED

## TDXU-FS L/D=2

Indexable drill, L/D = 2, flat shank with side port

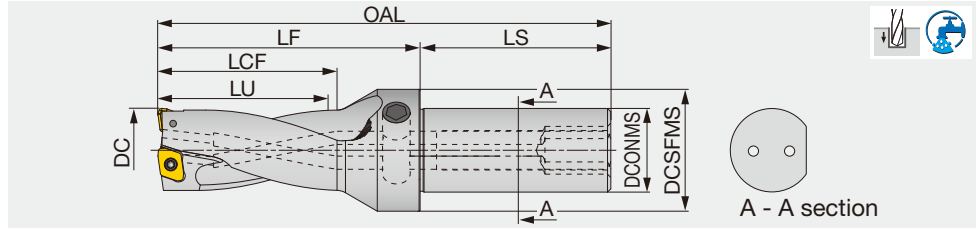

Inch	DC	DCONMS	DCSFMS	LU	LS	LCF	LF	OAL	Max. offset** (radial)	WT(lb)	Insert
TDXU-0500FS-02	0.500	0.750	1.250	1.015	1.015	1.130	2.019	4.034	0.030	0.440	XPMT040104R-D*
TDXU-0531FS-02	0.531	0.750	1.250	1.077	1.077	1.200	2.089	4.104	0.024	0.450	XPMT040104R-D*
TDXU-0562FS-02	0.562	0.750	1.250	1.139	1.139	1.260	2.152	4.167	0.018	0.450	XPMT040104R-D*
TDXU-0625FS-02	0.625	0.750	1.250	1.271	1.271	1.390	2.283	4.304	0.026	0.460	XPMT050204R-D*
TDXU-0687FS-02	0.687	1.000	1.457	1.393	1.393	1.510	2.471	4.770	0.048	0.790	XPMT06X308R-D*
TDXU-0750FS-02	0.75	1.000	1.457	1.519	1.519	1.640	2.591	4.890	0.027	0.820	XPMT06X308R-D*
TDXU-0812FS-02	0.812	1.000	1.457	1.643	1.643	1.760	2.729	5.028	0.015	0.850	XPMT06X308R-D*
TDXU-0875FS-02	0.875	1.000	1.457	1.773	1.773	1.890	2.849	5.152	0.045	0.880	XPMT07H308R-D*
TDXU-0937FS-02	0.937	1.000	1.457	1.897	1.897	2.020	2.991	5.294	0.029	0.930	XPMT07H308R-D*
TDXU-1000FS-02	1.000	1.000	1.457	2.023	2.023	2.140	3.111	5.414	0.013	0.960	XPMT07H308R-D*
TDXU-1062FS-02	1.062	1.250	1.575	2.153	2.153	2.270	3.401	5.710	0.059	1.300	XPMT08T308R-D*
TDXU-1125FS-02	1.125	1.250	1.575	2.279	2.279	2.400	3.541	5.850	0.043	1.380	XPMT08T308R-D*
TDXU-1187FS-02	1.187	1.250	1.575	2.403	2.403	2.520	3.658	5.967	0.026	1.450	XPMT08T308R-D*
TDXU-1250FS-02	1.250	1.250	1.575	2.529	2.529	2.650	3.783	6.092	0.010	1.520	XPMT08T308R-D*
TDXU-1312FS-02	1.312	1.500	1.969	2.667	2.667	2.790	4.013	6.744	0.088	2.250	XPMT110412R-D*
TDXU-1375FS-02	1.375	1.500	1.969	2.793	2.793	2.910	4.155	6.886	0.072	2.320	XPMT110412R-D*
TDXU-1437FS-02	1.437	1.500	1.969	2.917	2.917	3.040	4.272	7.003	0.055	2.340	XPMT110412R-D*
TDXU-1500FS-02	1.500	1.500	1.969	3.043	3.043	3.160	4.413	7.144	0.038	2.530	XPMT110412R-D*
TDXU-1562FS-02	1.562	1.500	1.969	3.167	3.167	3.290	4.553	7.284	0.022	2.540	XPMT110412R-D*
TDXU-1625FS-02	1.625	1.500	2.165	3.311	3.311	3.430	4.728	7.477	0.128	2.850	XPMT150512R-D*
TDXU-1687FS-02	1.687	1.500	2.165	3.435	3.435	3.550	4.868	7.617	0.115	3.020	XPMT150512R-D*
TDXU-1750FS-02	1.750	1.500	2.165	3.561	3.561	3.680	4.986	7.735	0.097	3.140	XPMT150512R-D*
TDXU-1812FS-02	1.812	1.500	2.165	3.685	3.685	3.810	5.128	7.877	0.082	3.300	XPMT150512R-D*
TDXU-1875FS-02	1.875	1.500	2.165	3.811	3.811	3.930	5.251	8.000	0.063	3.490	XPMT150512R-D*
TDXU-1937FS-02	1.937	1.500	2.165	3.935	3.935	4.050	5.385	8.134	0.049	3.610	XPMT150512R-D*
TDXU-2000FS-02	2.000	1.500	2.165	4.061	4.061	4.180	5.510	8.259	0.030	3.820	XPMT150512R-D*
TDXU-2125FS-02	2.125	1.500	2.165	4.311	4.311	4.430	5.790	8.548	-	4.240	XPMT150512R-D*

\*\* For offsetting on lathe

Tool diameter (in)	Tool diameter tolerance (in)	Hole diameter tolerance (in)
ø0.500" - ø0.625"	+ 0.004" / 0	+ 0.010" / 0
ø0.687" - ø2.125"	+ 0.008" / 0	+ 0.012" / 0

\*Just for reference

### SPARE PARTS



Designation	Clamping screw	Torx driver	Plug *	
			Side port	Rear port (Optional parts)
TDXU500 - TDXU0562	CSPB-2H	IP-6DB	NPTF1/8	(NPTF1/4)
TDXU-0625FS-02	CSPB-2L043	IP-6DB	NPTF1/8	(NPTF1/4)
TDXU0687 - TDXU0812	CSPB-2.2	IP-7D	NPTF1/8	(SL25IN)
TDXU0875 - TDXU1000	CSPB-2.5	IP-8D	NPTF1/8	(SL25IN)
TDXU1062 - TDXU1250	CSTB-3	T-9D	NPTF1/4	(SL32IN)
TDXU1312 - TDXU1562	CSTB-4	T-15D	NPTF1/4	(SL38IN)
TDXU1625 - TDXU2125	CSTB-5	T-20D	NPTF1/4	(SL38IN)

Recommended clamping torque: CSPB-2H/CSPB-2L043= 0.52 lb-ft, CSPB-2.2= 0.74 lb-ft, CSPB-2.5= 0.96 lb-ft, CSTB-3= 1.70 lb-ft, CSTB-4= 2.58 lb-ft, CSTB-5= 3.69 lb-ft

Reference pages: Inserts → **J088 - J089**  
Standard cutting conditions → **J090**

# TDX-F L/D=2

Indexable drill, L/D = 2, flat shank

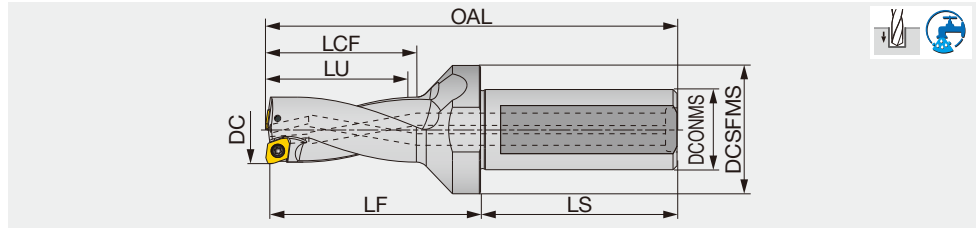

Metric	DC	DCONMS	DCSFMS	LU	LS	LCF	LF	OAL	Max. offset (radial)	WT(kg)	Insert
TDX125F20-2	12.5	20	25	25.4	49	28.4	41	90.4	0.8	0.2	XPMT040104R-D*
TDX130F20-2	13	20	25	26.4	49	29.4	42	91.4	0.7	0.2	XPMT040104R-D*
TDX135F20-2	13.5	20	25	27.4	49	30.4	43	92.4	0.6	0.2	XPMT040104R-D*
TDX140F20-2	14	20	25	28.4	49	31.4	44	93.4	0.5	0.2	XPMT040104R-D*
TDX145F20-2	14.5	20	25	29.4	49	32.4	46	95.4	0.4	0.2	XPMT040104R-D*
TDX150F20-2	15	20	25	30.5	49	33.5	47	96.5	0.9	0.2	XPMT050204R-D*
TDX155F20-2	15.5	20	32	31.5	49	34.5	49	98.5	0.8	0.2	XPMT050204R-D*
TDX160F20-2	16	20	32	32.5	49	35.5	51	100.5	0.6	0.2	XPMT050204R-D*
TDX165F20-2	16.5	20	32	33.5	49	36.5	52	101.5	0.5	0.2	XPMT050204R-D*
TDX170F20-2	17	20	32	34.5	49	37.5	53	102.5	0.4	0.2	XPMT050204R-D*
TDX175F25-2	17.5	25	32	35.5	54	38.5	55	109.5	1.2	0.3	XPMT06X308R-D*
TDX180F25-2	18	25	32	36.5	54	39.5	56	110.5	1.1	0.3	XPMT06X308R-D*
TDX185F25-2	18.5	25	32	37.5	54	40.5	57	111.5	0.9	0.3	XPMT06X308R-D*
TDX190F25-2	19	25	32	38.5	54	41.5	58	112.5	0.8	0.3	XPMT06X308R-D*
TDX195F25-2	19.5	25	32	39.5	54	42.5	60	114.5	0.7	0.3	XPMT06X308R-D*
TDX200F25-2	20	25	32	40.5	54	45.5	61	115.5	0.5	0.3	XPMT06X308R-D*
TDX205F25-2	20.5	25	32	41.5	54	46.5	62.5	117	0.4	0.3	XPMT06X308R-D*
TDX210F25-2	21	25	32	42.5	54	47.5	64	118.5	0.3	0.3	XPMT06X308R-D*
TDX215F25-2	21.5	25	32	43.5	54	48.5	65	119.5	0.2	0.3	XPMT06X308R-D*
TDX220F25-2	22	25	32	44.6	54	49.6	66	120.6	1.2	0.3	XPMT07H308R-D*
TDX225F25-2	22.5	25	37	45.6	54	50.6	67.5	122.1	1.1	0.3	XPMT07H308R-D*
TDX230F25-2	23	25	37	46.6	54	51.6	69	123.6	0.9	0.4	XPMT07H308R-D*
TDX235F25-2	23.5	25	37	47.6	54	52.6	70	124.6	0.8	0.4	XPMT07H308R-D*
TDX240F25-2	24	25	37	48.6	54	53.6	71	125.6	0.7	0.4	XPMT07H308R-D*
TDX245F25-2	24.5	25	37	49.6	54	54.6	72.5	127.1	0.5	0.4	XPMT07H308R-D*
TDX250F25-2	25	25	37	50.6	54	55.6	74	128.6	0.4	0.4	XPMT07H308R-D*
TDX255F25-2	25.5	25	37	51.6	54	56.6	75.5	130.1	0.3	0.4	XPMT07H308R-D*
TDX260F25-2	26	25	37	52.6	54	57.6	77	131.6	0.2	0.4	XPMT07H308R-D*
TDX270F32-2	27	32	40	54.7	59	59.7	79	138.7	1.5	0.6	XPMT08T308R-D*
TDX280F32-2	28	32	40	56.7	59	61	82.3	142	1.2	0.6	XPMT08T308R-D*
TDX290F32-2	29	32	40	58.7	59	63	84.3	144	1	0.7	XPMT08T308R-D*
TDX300F32-2	30	32	40	60.7	59	65	87.3	147	0.7	0.7	XPMT08T308R-D*
TDX310F32-2	31	32	40	62.7	59	67	90.3	150	0.4	0.7	XPMT08T308R-D*
TDX320F32-2	32	32	40	64.7	59	69	92.3	152	0.2	0.8	XPMT08T308R-D*
TDX330F40-2	33	40	50	67.1	69	71.7	95.6	165.7	2.3	1.2	XPMT110412R-D*
TDX340F40-2	34	40	50	69.1	69	73.7	98.6	168.7	2.1	1.2	XPMT110412R-D*
TDX350F40-2	35	40	50	71.1	69	75.7	101.6	171.7	1.8	1.2	XPMT110412R-D*
TDX360F40-2	36	40	50	73.1	69	77.7	104.6	174.7	1.5	1.3	XPMT110412R-D*
TDX370F40-2	37	40	50	75.1	69	79.7	105.6	175.7	1.3	1.3	XPMT110412R-D*
TDX380F40-2	38	40	50	77.1	69	81.7	108.6	178.7	1	1.3	XPMT110412R-D*
TDX390F40-2	39	40	50	79.1	69	83.7	110.6	180.7	0.7	1.4	XPMT110412R-D*
TDX400F40-2	40	40	50	81.1	69	85.7	113.6	183.7	0.5	1.4	XPMT110412R-D*
TDX410F40-2	41	40	50	83.1	69	87.7	117.6	187.7	0.2	1.5	XPMT110412R-D*
TDX420F40-2	42	40	55	85.6	69	90.6	120	190.6	3.1	1.6	XPMT150512R-D*
TDX430F40-2	43	40	55	87.6	69	92.6	123	193.6	2.9	1.6	XPMT150512R-D*
TDX440F40-2	44	40	55	89.6	69	94.6	125	195.6	2.6	1.7	XPMT150512R-D*
TDX450F40-2	45	40	55	91.6	69	96.6	128	198.6	2.3	1.7	XPMT150512R-D*
TDX460F40-2	46	40	55	93.6	69	98.6	131	201.6	2.1	1.8	XPMT150512R-D*
TDX470F40-2	47	40	55	95.6	69	100.6	133	203.6	1.8	1.9	XPMT150512R-D*
TDX480F40-2	48	40	55	97.6	69	102.6	136	206.6	1.5	1.9	XPMT150512R-D*
TDX490F40-2	49	40	55	99.6	69	104.6	138	208.6	1.3	1.9	XPMT150512R-D*
TDX500F40-2	50	40	55	101.6	69	106.6	141	211.6	1	2	XPMT150512R-D*
TDX510F40-2	51	40	55	103.6	69	108.6	145	215.6	0.7	2.1	XPMT150512R-D*
TDX520F40-2	52	40	55	105.6	69	110.6	147	217.6	0.5	2.2	XPMT150512R-D*
TDX530F40-2	53	40	55	107.6	69	112.6	150	220.6	-	2.3	XPMT150512R-D*
TDX540F40-2	54	40	55	109.6	69	114.6	152	222.6	-	2.4	XPMT150512R-D*

## SPARE PARTS

Designation	Clamping screw	Wrench
TDX125 - 145	CSPB-2H	IP-6DB
TDX150 - 170	CSPB-2L043	IP-6DB
TDX175 - 215	CSPB-2.2	IP-7D
TDX220 - 260	CSPB-2.5	IP-8D
TDX270 - 320	CSTB-3	T-9D
TDX330 - 410	CSTB-4	T-15D
TDX420 - 540	CSTB-5	T-20D

Tool diameter (mm)	Tool diameter tolerance (mm)	Hole diameter tolerance (mm)*
ø12.5 - ø17	+ 0.1 / 0	+ 0.25 / 0
ø17.5 - ø54	+ 0.2 / 0	+ 0.3 / 0

Recommended clamping torque: CSPB-2H/CSPB-2L043 = 0.7 N·m, CSPB-2.2 = 1 N·m, CSPB-2.5 = 1.3 N·m, CSTB-3 = 2.3 N·m, CSTB-4 = 3.5 N·m, CSTB-5 = 5 N·m

Reference pages: Inserts → **J088 - J089**

Standard cutting conditions → **J090**



# TUNGDRILL TWISTED

TDXU-F L/D=3

Indexable drill, L/D = 3, flat shank with side port

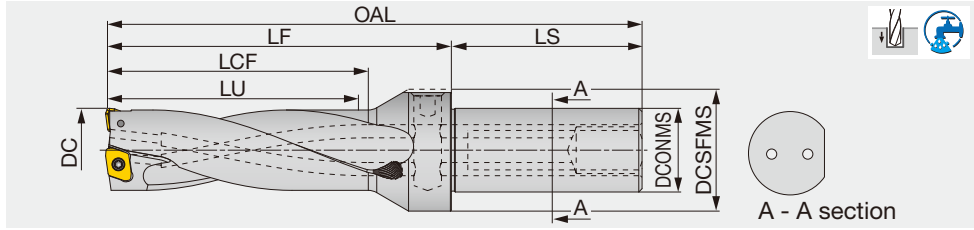

Inch	DC	DCONMS	DCSFMS	LU	LS	LCF	LF	OAL	Max. offset** (radial)	WT(lb)	Insert
TDXU-0500FS-03	0.500	0.750	1.250	1.515	2.000	1.630	2.519	4.534	0.030	0.450	XPMT040104R-D*
TDXU-0531FS-03	0.531	0.750	1.250	1.608	2.000	1.730	2.620	4.635	0.024	0.460	XPMT040104R-D*
TDXU-0562FS-03	0.562	0.750	1.250	1.701	2.000	1.820	2.715	4.730	0.018	0.470	XPMT040104R-D*
TDXU-0625FS-03	0.625	0.750	1.250	1.896	2.000	2.020	2.909	4.930	0.026	0.490	XPMT050204R-D*
TDXU-0687FS-03	0.687	1.000	1.457	2.080	2.280	2.200	3.159	5.458	0.048	0.830	XPMT06X308R-D*
TDXU-0750FS-03	0.750	1.000	1.457	2.269	2.280	2.390	3.341	5.640	0.027	0.870	XPMT06X308R-D*
TDXU-0812FS-03	0.812	1.000	1.457	2.455	2.280	2.580	3.542	5.841	0.015	0.910	XPMT06X308R-D*
TDXU-0875FS-03	0.875	1.000	1.457	2.648	2.280	2.770	3.724	6.027	0.045	0.950	XPMT07H308R-D*
TDXU-0937FS-03	0.937	1.000	1.457	2.834	2.280	2.960	3.929	6.232	0.029	1.030	XPMT07H308R-D*
TDXU-1000FS-03	1.000	1.000	1.457	3.023	2.280	3.210	4.111	6.314	0.013	1.050	XPMT07H308R-D*
TDXU-1062FS-03	1.062	1.250	1.575	3.215	2.280	3.340	4.464	6.773	0.059	1.430	XPMT08T308R-D*
TDXU-1125FS-03	1.125	1.250	1.575	3.404	2.280	3.520	4.666	6.975	0.043	1.520	XPMT08T308R-D*
TDXU-1187FS-03	1.187	1.250	1.575	3.590	2.280	3.710	4.845	7.154	0.026	1.620	XPMT08T308R-D*
TDXU-1250FS-03	1.250	1.250	1.575	3.779	2.280	3.900	5.033	7.342	0.010	1.740	XPMT08T308R-D*
TDXU-1312FS-03	1.312	1.500	1.969	3.979	2.688	4.100	5.325	8.056	0.088	2.510	XPMT110412R-D*
TDXU-1375FS-03	1.375	1.500	1.969	4.168	2.688	4.290	5.530	8.261	0.072	2.610	XPMT110412R-D*
TDXU-1437FS-03	1.437	1.500	1.969	4.354	2.688	4.470	5.709	8.440	0.055	2.630	XPMT110412R-D*
TDXU-1500FS-03	1.500	1.500	1.969	4.543	2.688	4.660	5.913	8.644	0.038	2.860	XPMT110412R-D*
TDXU-1562FS-03	1.562	1.500	1.969	4.729	2.688	4.850	6.115	8.846	0.022	2.920	XPMT110412R-D*
TDXU-1625FS-03	1.625	1.500	2.165	4.936	2.688	5.050	6.353	9.102	0.128	3.330	XPMT150512R-D*
TDXU-1687FS-03	1.687	1.500	2.165	5.122	2.688	5.240	6.555	9.304	0.115	3.570	XPMT150512R-D*
TDXU-1750FS-03	1.750	1.500	2.165	5.311	2.688	5.430	6.736	9.485	0.097	3.740	XPMT150512R-D*
TDXU-1812FS-03	1.812	1.500	2.165	5.497	2.688	5.620	6.941	9.690	0.082	3.950	XPMT150512R-D*
TDXU-1875FS-03	1.875	1.500	2.165	5.686	2.688	5.800	7.126	9.875	0.063	4.220	XPMT150512R-D*
TDXU-1937FS-03	1.937	1.500	2.165	5.872	2.688	5.990	7.322	10.071	0.049	4.410	XPMT150512R-D*
TDXU-2000FS-03	2.000	1.500	2.165	6.061	2.688	6.180	7.510	10.259	0.030	4.60	XPMT150512R-D*
TDXU-2125FS-03	2.125	1.500	2.165	6.436	2.688	6.550	7.915	10.664	-	5.310	XPMT150512R-D*

\*\* For offsetting on lathe

Tool diameter (in)	Tool diameter tolerance (in)	Hole diameter tolerance (in)*
ø0.500" - ø0.625"	+ 0.004" / 0	+ 0.010" / 0
ø0.687" - ø2.125"	+ 0.008" / 0	+ 0.012" / 0

\*Just for reference

## SPARE PARTS



Designation	Clamping screw	Torx driver	Plug *	
			Side port	Rear port (Optional parts)
TDXU500 - TDXU0562	CSPB-2H	IP-6DB	NPTF1/8	(NPTF1/4)
TDXU-0625FS-03	CSPB-2L043	IP-6DB	NPTF1/8	(NPTF1/4)
TDXU0687-TDXU0812	CSPB-2.2	IP-7D	NPTF1/8	(SL25IN)
TDXU0875 - TDXU1000	CSPB-2.5	IP-8D	NPTF1/8	(SL25IN)
TDXU1062 - TDXU1250	CSTB-3	T-9D	NPTF1/4	(SL32IN)
TDXU1312 - TDXU1562	CSTB-4	T-15D	NPTF1/4	(SL38IN)
TDXU1625 - TDXU2125	CSTB-5	T-20D	NPTF1/4	(SL38IN)

Recommended clamping torque: CSPB-2H/CSPB-2L043 = 0.52 lb-ft, CSPB-2.2 = 0.74 lb-ft, CSPB-2.5 = 0.96 lb-ft, CSTB-3 = 1.70 lb-ft, CSTB-4 = 2.58 lb-ft, CSTB-5 = 3.69 lb-ft

Reference pages: Inserts → **J088 - J089**  
Standard cutting conditions → **J090**



# TDX-F L/D=3

Indexable drill, L/D = 3, flat shank

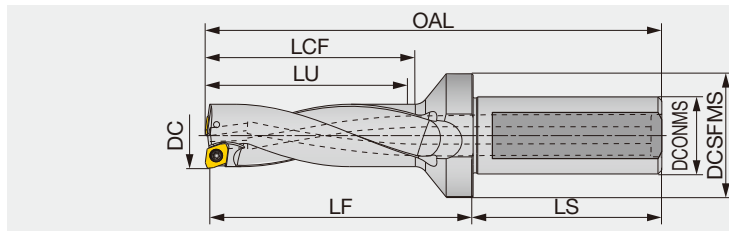

Metric	DC	DCONMS	DCSFMS	LU	LS	LCF	LF	OAL	Max. offset (radial)	WT(kg)	Insert
TDX125F20-3	12.5	20	25	37.9	49	40.9	53	102.4	0.8	0.2	XPMT040104R-D*
TDX130F20-3	13	20	25	39.4	49	42.4	55	104.4	0.7	0.2	XPMT040104R-D*
TDX135F20-3	13.5	20	25	40.9	49	43.9	56	105.4	0.6	0.2	XPMT040104R-D*
TDX140F20-3	14	20	25	42.4	49	45.4	58	107.4	0.5	0.2	XPMT040104R-D*
TDX145F20-3	14.5	20	25	43.9	49	46.9	60	109.4	0.4	0.2	XPMT040104R-D*
TDX150F20-3	15	20	25	45.4	49	48.4	62	111.4	0.9	0.2	XPMT050204R-D*
TDX155F20-3	15.5	20	32	46.9	49	49.9	64	113.4	0.8	0.2	XPMT050204R-D*
TDX160F20-3	16	20	32	48.4	49	51.4	66	115.4	0.6	0.2	XPMT050204R-D*
TDX165F20-3	16.5	20	32	49.9	49	52.9	68	117.4	0.5	0.2	XPMT050204R-D*
TDX170F20-3	17	20	32	51.4	49	54.4	69	118.4	0.4	0.2	XPMT050204R-D*
TDX175F25-3	17.5	25	32	53	54	56	72	126.5	1.2	0.3	XPMT06X308R-D*
TDX180F25-3	18	25	32	54.5	54	57.5	73	127.5	1.1	0.3	XPMT06X308R-D*
TDX185F25-3	18.5	25	32	56	54	59	75	129.5	0.9	0.3	XPMT06X308R-D*
TDX190F25-3	19	25	32	57.5	54	60.5	76	130.5	0.8	0.3	XPMT06X308R-D*
TDX195F25-3	19.5	25	32	59	54	62	79	133.5	0.7	0.3	XPMT06X308R-D*
TDX200F25-3	20	25	32	60.5	54	65.5	81	135.5	0.5	0.3	XPMT06X308R-D*
TDX205F25-3	20.5	25	32	62	54	67	82	136.5	0.4	0.3	XPMT06X308R-D*
TDX210F25-3	21	25	32	63.5	54	68.5	84	138.5	0.3	0.3	XPMT06X308R-D*
TDX215F25-3	21.5	25	32	65	54	70	86	140.5	0.2	0.4	XPMT06X308R-D*
TDX220F25-3	22	25	32	66.6	54	71.6	87	141.6	1.2	0.4	XPMT07H308R-D*
TDX225F25-3	22.5	25	37	68.1	54	73.1	90	144.6	1.1	0.4	XPMT07H308R-D*
TDX230F25-3	23	25	37	69.6	54	74.6	91	145.6	0.9	0.4	XPMT07H308R-D*
TDX235F25-3	23.5	25	37	71.1	54	76.1	93	147.6	0.8	0.4	XPMT07H308R-D*
TDX240F25-3	24	25	37	72.6	54	77.6	95	149.6	0.7	0.4	XPMT07H308R-D*
TDX245F25-3	24.5	25	37	74.1	54	79.1	97	151.6	0.5	0.5	XPMT07H308R-D*
TDX250F25-3	25	25	37	75.6	54	80.6	99	153.6	0.4	0.5	XPMT07H308R-D*
TDX255F25-3	25.5	25	37	77.1	54	82.1	100	154.6	0.3	0.5	XPMT07H308R-D*
TDX260F25-3	26	25	37	78.6	54	83.6	102	156.6	0.2	0.5	XPMT07H308R-D*
TDX270F32-3	27	32	40	81.7	59	86.7	105	164.7	1.5	0.6	XPMT08T308R-D*
TDX280F32-3	28	32	40	84.7	59	89	109.3	169	1.2	0.7	XPMT08T308R-D*
TDX290F32-3	29	32	40	87.7	59	92	112.3	172	1	0.7	XPMT08T308R-D*
TDX300F32-3	30	32	40	90.7	59	95	117.3	177	0.7	0.8	XPMT08T308R-D*
TDX310F32-3	31	32	40	93.7	59	98	121.3	181	0.4	0.8	XPMT08T308R-D*
TDX320F32-3	32	32	40	96.7	59	101	124.3	184	0.2	0.9	XPMT08T308R-D*
TDX330F40-3	33	40	50	100.1	69	104.7	128.6	198.7	2.3	1.3	XPMT110412R-D*
TDX340F40-3	34	40	50	103.1	69	107.7	131.6	201.7	2.1	1.3	XPMT110412R-D*
TDX350F40-3	35	40	50	106.1	69	110.7	135.6	205.7	1.8	1.3	XPMT110412R-D*
TDX360F40-3	36	40	50	109.1	69	113.7	139.6	209.7	1.5	1.4	XPMT110412R-D*
TDX370F40-3	37	40	50	112.1	69	116.7	142.6	212.7	1.3	1.4	XPMT110412R-D*
TDX380F40-3	38	40	50	115.1	69	119.7	146.6	216.7	1	1.5	XPMT110412R-D*
TDX390F40-3	39	40	50	118.1	69	122.7	149.6	219.7	0.7	1.6	XPMT110412R-D*
TDX400F40-3	40	40	50	121.1	69	125.7	153.6	223.7	0.5	1.6	XPMT110412R-D*
TDX410F40-3	41	40	50	124.1	69	128.7	157.6	227.7	0.2	1.7	XPMT110412R-D*
TDX420F40-3	42	40	55	127.6	69	132.6	161	231.6	3.1	1.8	XPMT150512R-D*
TDX430F40-3	43	40	55	130.6	69	135.6	165	235.6	2.9	1.8	XPMT150512R-D*
TDX440F40-3	44	40	55	133.6	69	138.6	168	238.6	2.6	1.9	XPMT150512R-D*
TDX450F40-3	45	40	55	136.6	69	141.6	173	243.6	2.3	2	XPMT150512R-D*
TDX460F40-3	46	40	55	139.6	69	144.6	177	247.6	2.1	2.1	XPMT150512R-D*
TDX470F40-3	47	40	55	142.6	69	147.6	180	250.6	1.8	2.2	XPMT150512R-D*
TDX480F40-3	48	40	55	145.6	69	150.6	184	254.6	1.5	2.3	XPMT150512R-D*
TDX490F40-3	49	40	55	148.6	69	153.6	187	257.6	1.3	2.3	XPMT150512R-D*
TDX500F40-3	50	40	55	151.6	69	156.6	191	261.6	1	2.4	XPMT150512R-D*
TDX510F40-3	51	40	55	154.6	69	159.6	195	265.6	0.7	2.5	XPMT150512R-D*
TDX520F40-3	52	40	55	157.6	69	162.6	198	268.6	0.5	2.6	XPMT150512R-D*
TDX530F40-3	53	40	55	160.6	69	165.6	202	272.6	-	2.7	XPMT150512R-D*
TDX540F40-3	54	40	55	163.6	69	168.6	205	275.6	-	2.9	XPMT150512R-D*

## SPARE PARTS

Designation	Clamping screw	Wrench
TDX125 - 145	CSPB-2H	IP-6DB
TDX150 - 170	CSPB-2L043	IP-6DB
TDX175 - 215	CSPB-2.2	IP-7D
TDX220 - 260	CSPB-2.5	IP-8D
TDX270 - 320	CSTB-3	T-9D
TDX330 - 410	CSTB-4	T-15D
TDX420 - 540	CSTB-5	T-20D

Tool diameter (mm)	Tool diameter tolerance (mm)	Hole diameter tolerance (mm)*
ø12.5 - ø17	+ 0.1 / 0	+ 0.25 / 0
ø17.5 - ø54	+ 0.2 / 0	+ 0.3 / 0

Recommended clamping torque: CSPB-2H/CSPB-2L043 = 0.7 N-m, CSPB-2.2 = 1 N-m, CSPB-2.5 = 1.3 N-m, CSTB-3 = 2.3 N-m, CSTB-4 = 3.5 N-m, CSTB-5 = 5 N-m

Reference pages: Inserts → **J088 - J089**

Standard cutting conditions → **J090**



# TUNGDRILL TWISTED

TDXU-F L/D=4

Indexable drill, L/D = 4, flat shank with side port

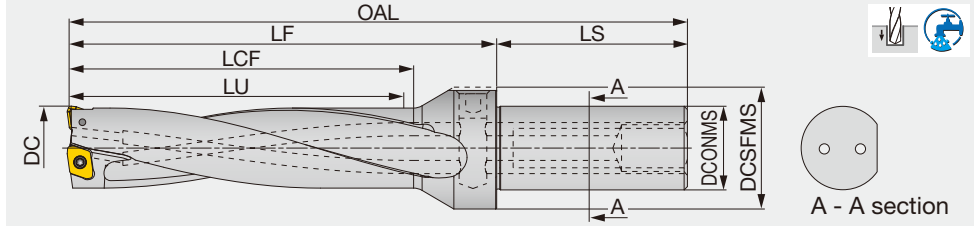

Inch	DC	DCONMS	DCSFMS	LU	LS	LCF	LF	OAL	Max. offset** (radial)	WT(lb)	Insert
TDXU-0500FS-04	0.500	0.750	1.250	2.015	2.000	2.130	3.019	5.034	0.030	0.460	XPMT040104R-D*
TDXU-0531FS-04	0.531	0.750	1.250	2.139	2.000	2.260	3.151	5.166	0.024	0.480	XPMT040104R-D*
TDXU-0562FS-04	0.562	0.750	1.250	2.263	2.000	2.390	3.278	5.293	0.018	0.490	XPMT040104R-D*
TDXU-0625FS-04	0.625	0.750	1.250	2.521	2.000	2.640	3.535	5.556	0.026	0.520	XPMT050204R-D*
TDXU-0687FS-04	0.687	1.000	1.457	2.767	2.280	2.890	3.847	6.146	0.048	0.860	XPMT06X308R-D*
TDXU-0750FS-04	0.750	1.000	1.457	3.019	2.280	3.140	4.091	6.390	0.027	0.920	XPMT06X308R-D*
TDXU-0812FS-04	0.812	1.000	1.457	3.267	2.280	3.390	4.355	6.654	0.015	0.960	XPMT06X308R-D*
TDXU-0875FS-04	0.875	1.000	1.457	3.523	2.280	3.640	4.599	6.902	0.045	1.030	XPMT07H308R-D*
TDXU-0937FS-04	0.937	1.000	1.457	3.771	2.280	3.890	4.867	7.170	0.029	1.130	XPMT07H308R-D*
TDXU-1000FS-04	1.000	1.000	1.457	4.023	2.280	4.140	5.111	7.414	0.013	1.140	XPMT07H308R-D*
TDXU-1062FS-04	1.062	1.250	1.575	4.277	2.280	4.400	5.527	7.836	0.059	1.560	XPMT08T308R-D*
TDXU-1125FS-04	1.125	1.250	1.575	4.529	2.280	4.650	5.791	8.100	0.043	1.660	XPMT08T308R-D*
TDXU-1187FS-04	1.187	1.250	1.575	4.777	2.280	4.900	6.032	8.341	0.026	1.800	XPMT08T308R-D*
TDXU-1250FS-04	1.250	1.250	1.575	5.029	2.280	5.150	6.283	8.592	0.010	1.950	XPMT08T308R-D*
TDXU-1312FS-04	1.312	1.500	1.969	5.291	2.688	5.410	6.637	9.368	0.088	2.770	XPMT110412R-D*
TDXU-1375FS-04	1.375	1.500	1.969	5.543	2.688	5.660	6.905	9.636	0.072	2.900	XPMT110412R-D*
TDXU-1437FS-04	1.437	1.500	1.969	5.791	2.688	5.910	7.146	9.877	0.055	2.930	XPMT110412R-D*
TDXU-1500FS-04	1.500	1.500	1.969	6.043	2.688	6.160	7.413	10.144	0.038	3.180	XPMT110412R-D*
TDXU-1562FS-04	1.562	1.500	1.969	6.291	2.688	6.410	7.677	10.408	0.022	3.310	XPMT110412R-D*
TDXU-1625FS-04	1.625	1.500	2.165	6.561	2.688	6.680	7.978	10.727	0.128	3.820	XPMT150512R-D*
TDXU-1687FS-04	1.687	1.500	2.165	6.809	2.688	6.930	8.242	10.991	0.115	4.120	XPMT150512R-D*
TDXU-1750FS-04	1.750	1.500	2.165	7.061	2.688	7.180	8.486	11.235	0.097	4.340	XPMT150512R-D*
TDXU-1812FS-04	1.812	1.500	2.165	7.309	2.688	7.430	8.754	11.503	0.082	4.600	XPMT150512R-D*
TDXU-1875FS-04	1.875	1.500	2.165	7.561	2.688	7.680	9.001	11.750	0.063	4.950	XPMT150512R-D*
TDXU-1937FS-04	1.937	1.500	2.165	7.809	2.688	7.930	9.259	12.008	0.049	5.210	XPMT150512R-D*
TDXU-2000FS-04	2.000	1.500	2.165	8.061	2.688	8.180	9.510	12.259	0.030	5.370	XPMT150512R-D*
TDXU-2125FS-04	2.125	1.500	2.165	8.561	2.688	8.680	10.040	12.789	-	6.390	XPMT150512R-D*

\*\* For offsetting on lathe

Tool diameter (in)	Tool diameter tolerance (in)	Hole diameter tolerance (in)
ø0.500" - ø0.625"	+ 0.004" / 0	+ 0.016" / 0
ø0.687" - ø2.125"	+ 0.008" / 0	+ 0.018" / 0

\*Just for reference

## SPARE PARTS



Designation	Clamping screw	Torx driver	Plug *	
			Side port	Rear port (Optional parts)
TDXU500 - TDXU0562	CSPB-2H	IP-6DB	NPTF1/8	(NPTF1/4)
TDXU-0625FS-04	CSPB-2L043	IP-6DB	NPTF1/8	(NPTF1/4)
TDXU0687 - TDXU0812	CSPB-2.2	IP-7D	NPTF1/8	(SL25IN)
TDXU0875 - TDXU1000	CSPB-2.5	IP-8D	NPTF1/8	(SL25IN)
TDXU1062 - TDXU1250	CSTB-3	T-9D	NPTF1/4	(SL32IN)
TDXU1312 - TDXU1562	CSTB-4	T-15D	NPTF1/4	(SL38IN)
TDXU1625 - TDXU2000	CSTB-5	T-20D	NPTF1/4	(SL38IN)

Recommended clamping torque: CSPB-2H/CSPB-2L043 = 0.52 lb-ft, CSPB-2.2 = 0.74 lb-ft, CSPB-2.5 = 0.96 lb-ft, CSTB-3 = 1.70 lb-ft, CSTB-4 = 2.58 lb-ft, CSTB-5 = 3.69 lb-ft

Reference pages: Inserts → **J088 - J089**  
Standard cutting conditions → **J090**

# TDX-F L/D=4

Indexable drill, L/D = 4, flat shank

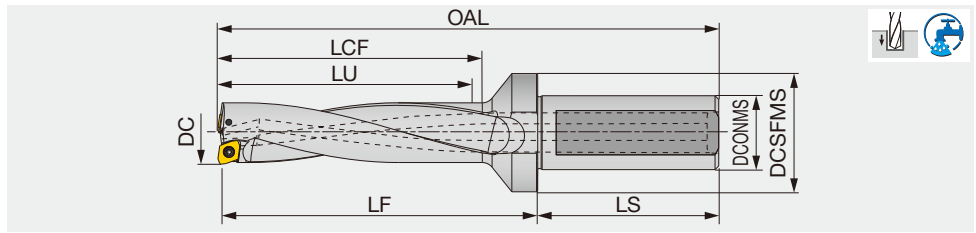

Metric	DC	DCONMS	DCSFMS	LU	LS	LCF	LF	OAL	Max. offset (radial)	WT(kg)	Insert
TDX125F20-4	12.5	20	25	50.4	49	53.4	66	115.4	0.8	0.2	XPMT040104R-D*
TDX130F20-4	13	20	25	52.4	49	55.4	68	117.4	0.7	0.2	XPMT040104R-D*
TDX135F20-4	13.5	20	25	54.4	49	57.4	70	119.4	0.6	0.2	XPMT040104R-D*
TDX140F20-4	14	20	25	56.4	49	59.4	72	121.4	0.5	0.2	XPMT040104R-D*
TDX145F20-4	14.5	20	25	58.4	49	61.4	75	124.4	0.4	0.2	XPMT040104R-D*
TDX150F20-4	15	20	25	60.4	49	63.4	77	126.4	0.9	0.2	XPMT050204R-D*
TDX155F20-4	15.5	20	32	62.4	49	65.4	79	128.4	0.8	0.2	XPMT050204R-D*
TDX160F20-4	16	20	32	64.4	49	67.4	82	131.4	0.6	0.2	XPMT050204R-D*
TDX165F20-4	16.5	20	32	66.4	49	69.4	84	133.4	0.5	0.2	XPMT050204R-D*
TDX170F20-4	17	20	32	68.4	49	71.4	86	135.4	0.4	0.2	XPMT050204R-D*
TDX175F25-4	17.5	25	32	70.5	54	73.5	89	143.5	1.2	0.3	XPMT06X308R-D*
TDX180F25-4	18	25	32	72.5	54	75.5	91	145.5	1.1	0.3	XPMT06X308R-D*
TDX185F25-4	18.5	25	32	74.5	54	77.5	93	147.5	0.9	0.3	XPMT06X308R-D*
TDX190F25-4	19	25	32	76.5	54	79.5	95	149.5	0.8	0.3	XPMT06X308R-D*
TDX195F25-4	19.5	25	32	78.5	54	81.5	99	153.5	0.7	0.4	XPMT06X308R-D*
TDX200F25-4	20	25	32	80.5	54	84.5	101	155.5	0.5	0.4	XPMT06X308R-D*
TDX205F25-4	20.5	25	32	82.5	54	86.5	103	157.5	0.4	0.4	XPMT06X308R-D*
TDX210F25-4	21	25	32	84.5	54	88.5	105	159.5	0.3	0.4	XPMT06X308R-D*
TDX215F25-4	21.5	25	32	86.5	54	90.5	107	161.5	0.2	0.4	XPMT06X308R-D*
TDX220F25-4	22	25	32	88.6	54	92.6	109	163.6	1.2	0.5	XPMT07H308R-D*
TDX225F25-4	22.5	25	37	90.6	54	94.6	111.5	166.1	1.1	0.5	XPMT07H308R-D*
TDX230F25-4	23	25	37	92.6	54	96.6	114	168.6	0.9	0.4	XPMT07H308R-D*
TDX235F25-4	23.5	25	37	94.6	54	98.6	116.5	171.1	0.8	0.4	XPMT07H308R-D*
TDX240F25-4	24	25	37	96.6	54	100.6	119	173.6	0.7	0.4	XPMT07H308R-D*
TDX245F25-4	24.5	25	37	98.6	54	102.6	121.5	176.1	0.5	0.6	XPMT07H308R-D*
TDX250F25-4	25	25	37	100.6	54	104.6	124	178.6	0.4	0.6	XPMT07H308R-D*
TDX255F25-4	25.5	25	37	102.6	54	106.6	126	180.6	0.3	0.6	XPMT07H308R-D*
TDX260F25-4	26	25	37	104.6	54	108.6	128	182.6	0.2	0.6	XPMT07H308R-D*
TDX270F32-4	27	32	40	108.7	59	112.7	132	191.7	1.5	0.6	XPMT08T308R-D*
TDX280F32-4	28	32	40	112.7	59	116.7	137	196.7	1.2	0.8	XPMT08T308R-D*
TDX290F32-4	29	32	40	116.7	59	120.7	141	200.7	1	0.7	XPMT08T308R-D*
TDX300F32-4	30	32	40	120.7	59	124.7	147	206.7	0.7	0.9	XPMT08T308R-D*
TDX310F32-4	31	32	40	124.7	59	128.7	152	211.7	0.4	0.9	XPMT08T308R-D*
TDX320F32-4	32	32	40	128.7	59	132.7	156	215.7	0.2	1	XPMT08T308R-D*
TDX330F40-4	33	40	50	133.1	69	137.1	161	231.1	2.3	1.4	XPMT110412R-D*
TDX340F40-4	34	40	50	137.1	69	141.1	165	235.1	2.1	1.4	XPMT110412R-D*
TDX350F40-4	35	40	50	141.1	69	145.1	170	240.1	1.8	1.4	XPMT110412R-D*
TDX360F40-4	36	40	50	145.1	69	149.1	175	245.1	1.5	1.5	XPMT110412R-D*
TDX370F40-4	37	40	50	149.1	69	153.1	179	249.1	1.3	1.5	XPMT110412R-D*
TDX380F40-4	38	40	50	153.1	69	157.1	184	254.1	1	1.7	XPMT110412R-D*
TDX390F40-4	39	40	50	157.1	69	161.1	188	258.1	0.7	1.8	XPMT110412R-D*
TDX400F40-4	40	40	50	161.1	69	165.1	193	263.1	0.5	1.8	XPMT110412R-D*
TDX410F40-4	41	40	50	165.1	69	169.1	198	268.1	0.2	1.9	XPMT110412R-D*
TDX420F40-4	42	40	55	169.6	69	173.6	202	272.6	3.1	2	XPMT150512R-D*
TDX430F40-4	43	40	55	173.6	69	177.6	207	277.6	2.9	2	XPMT150512R-D*
TDX440F40-4	44	40	55	177.6	69	181.6	211	281.6	2.6	2.1	XPMT150512R-D*
TDX450F40-4	45	40	55	181.6	69	185.6	217	287.6	2.3	2.3	XPMT150512R-D*
TDX460F40-4	46	40	55	185.6	69	189.6	222	292.6	2.1	2.4	XPMT150512R-D*
TDX470F40-4	47	40	55	189.6	69	193.6	226	296.6	1.8	2.5	XPMT150512R-D*
TDX480F40-4	48	40	55	193.6	69	197.6	231	301.6	1.5	2.7	XPMT150512R-D*
TDX490F40-4	49	40	55	197.6	69	201.6	235	305.6	1.3	2.7	XPMT150512R-D*
TDX500F40-4	50	40	55	201.6	69	205.6	240	310.6	1	2.8	XPMT150512R-D*
TDX510F40-4	51	40	55	205.6	69	209.6	245	315.6	0.7	2.9	XPMT150512R-D*
TDX520F40-4	52	40	55	209.6	69	213.6	249	319.6	0.5	3	XPMT150512R-D*
TDX530F40-4	53	40	55	213.6	69	217.6	254	324.6	-	3.1	XPMT150512R-D*
TDX540F40-4	54	40	55	217.6	69	221.6	258	328.6	-	3.4	XPMT150512R-D*

## SPARE PARTS

Designation	Clamping screw	Wrench
TDX125 - 145	CSPB-2H	IP-6DB
TDX150 - 170	CSPB-2L043	IP-6DB
TDX175 - 215	CSPB-2.2	IP-7D
TDX220 - 260	CSPB-2.5	IP-8D
TDX270 - 320	CSTB-3	T-9D
TDX330 - 410	CSTB-4	T-15D
TDX420 - 540	CSTB-5	T-20D

Tool diameter (mm)	Tool diameter tolerance (mm)	Hole diameter tolerance (mm)*
ø12.5 - ø17	+ 0.1 / 0	+ 0.4 / 0
ø17.5 - ø54	+ 0.2 / 0	+ 0.45 / 0

\*Just for reference

Recommended clamping torque: CSPB-2H/CSPB-2L043 = 0.7 N·m, CSPB-2.2 = 1 N·m, CSPB-2.5 = 1.3 N·m, CSTB-3 = 2.3 N·m, CSTB-4 = 3.5 N·m, CSTB-5 = 5 N·m

Reference pages: Inserts → **J088 - J089**

Standard cutting conditions → **J090**



# TUNGDRILL TWISTED

TDXU-F L/D=5

Indexable drill, L/D = 5, flat shank with side port

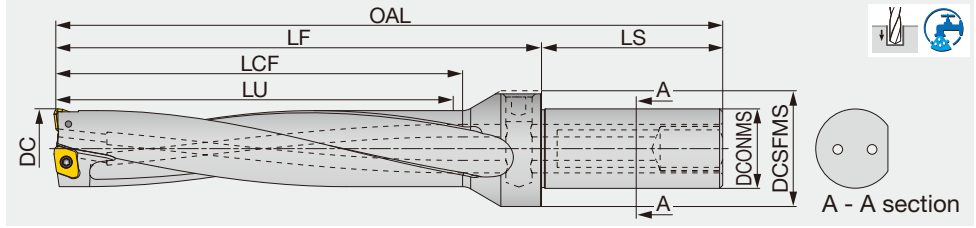

Inch	DC	DCONMS	DCSFMS	LU	LS	LCF	LF	OAL	Max. offset** (radial)	WT(lb)	Insert
TDXU-0500FS-05	0.500	0.750	1.250	2.515	2.000	2.630	3.519	5.534	0.030	0.470	XPMT040104R-D*
TDXU-0531FS-05	0.531	0.750	1.250	2.670	2.000	2.790	3.682	5.697	0.024	0.500	XPMT040104R-D*
TDXU-0562FS-05	0.562	0.750	1.250	2.825	2.000	2.950	3.841	5.856	0.018	0.510	XPMT040104R-D*
TDXU-0625FS-05	0.625	0.750	1.250	3.146	2.000	3.270	4.161	6.182	0.026	0.550	XPMT050204R-D*
TDXU-0687FS-05	0.687	1.000	1.457	3.454	2.280	3.580	4.535	6.834	0.048	0.900	XPMT06X308R-D*
TDXU-0750FS-05	0.750	1.000	1.457	3.769	2.280	3.890	4.841	7.140	0.027	0.960	XPMT06X308R-D*
TDXU-0812FS-05	0.812	1.000	1.457	4.079	2.280	4.200	5.168	7.467	0.015	1.020	XPMT06X308R-D*
TDXU-0875FS-05	0.875	1.000	1.457	4.398	2.280	4.520	5.474	7.777	0.045	1.100	XPMT07H308R-D*
TDXU-0937FS-05	0.937	1.000	1.457	4.708	2.280	4.830	5.805	8.108	0.029	1.220	XPMT07H308R-D*
TDXU-1000FS-05	1.000	1.000	1.457	5.023	2.280	5.140	6.111	8.414	0.013	1.230	XPMT07H308R-D*
TDXU-1062FS-05	1.062	1.250	1.575	5.339	2.280	5.460	6.590	8.899	0.059	1.690	XPMT08T308R-D*
TDXU-1125FS-05	1.125	1.250	1.575	5.654	2.280	5.770	6.916	9.225	0.043	1.810	XPMT08T308R-D*
TDXU-1187FS-05	1.187	1.250	1.575	5.964	2.280	6.080	7.219	9.528	0.026	1.970	XPMT08T308R-D*
TDXU-1250FS-05	1.250	1.250	1.575	6.279	2.280	6.400	7.533	9.842	0.010	2.160	XPMT08T308R-D*
TDXU-1312FS-05	1.312	1.500	1.969	6.603	2.688	6.720	7.949	10.680	0.088	3.030	XPMT110412R-D*
TDXU-1375FS-05	1.375	1.500	1.969	6.918	2.688	7.040	8.280	11.011	0.072	3.190	XPMT110412R-D*
TDXU-1437FS-05	1.437	1.500	1.969	7.228	2.688	7.350	8.583	11.314	0.055	3.220	XPMT110412R-D*
TDXU-1500FS-05	1.500	1.500	1.969	7.543	2.688	7.660	8.913	11.644	0.038	3.510	XPMT110412R-D*
TDXU-1562FS-05	1.562	1.500	1.969	7.853	2.688	7.970	9.239	11.970	0.022	3.700	XPMT110412R-D*
TDXU-1625FS-05	1.625	1.500	2.165	8.186	2.688	8.300	9.603	12.352	0.128	4.300	XPMT150512R-D*
TDXU-1687FS-05	1.687	1.500	2.165	8.496	2.688	8.610	9.929	12.678	0.115	4.670	XPMT150512R-D*
TDXU-1750FS-05	1.750	1.500	2.165	8.811	2.688	8.930	10.236	12.985	0.097	4.940	XPMT150512R-D*
TDXU-1812FS-05	1.812	1.500	2.165	9.121	2.688	9.240	10.567	13.316	0.082	5.250	XPMT150512R-D*
TDXU-1875FS-05	1.875	1.500	2.165	9.436	2.688	9.550	10.876	13.625	0.063	5.680	XPMT150512R-D*
TDXU-1937FS-05	1.937	1.500	2.165	9.746	2.688	9.860	11.196	13.945	0.049	6.010	XPMT150512R-D*
TDXU-2000FS-05	2.000	1.500	2.165	10.061	2.688	10.180	11.510	14.259	0.030	6.140	XPMT150512R-D*
TDXU-2125FS-05	2.125	1.500	2.165	10.686	2.688	10.800	12.165	14.914	-	7.460	XPMT150512R-D*

\*\* For offsetting on lathe

Tool diameter (in)	Tool diameter tolerance (in)	Hole diameter tolerance (in)
ø0.500" - ø0.625"	+ 0.004" / 0	+ 0.016" / 0
ø0.687" - ø2.125"	+ 0.008" / 0	+ 0.018" / 0

\*Just for reference

## SPARE PARTS



Designation	Clamping screw	Torx driver	Plug *	
			Side port	Rear port (Optional parts)
TDXU500 - TDXU0562	CSPB-2H	IP-6DB	NPTF1/8	(NPTF1/4)
TDXU-0625FS-05	CSPB-2L043	IP-6DB	NPTF1/8	(NPTF1/4)
TDXU0687 - TDXU0812	CSPB-2.2	IP-7D	NPTF1/8	(SL25IN)
TDXU0875 - TDXU1000	CSPB-2.5	IP-8D	NPTF1/8	(SL25IN)
TDXU1062 - TDXU1250	CSTB-3	T-9D	NPTF1/4	(SL32IN)
TDXU1312 - TDXU1562	CSTB-4	T-15D	NPTF1/4	(SL38IN)
TDXU1625 - TDXU2000	CSTB-5	T-20D	NPTF1/4	(SL38IN)

Recommended clamping torque: CSPB-2H/CSPB-2L043 = 0.52 lb-ft, CSPB-2.2 = 0.74 lb-ft, CSPB-2.5 = 0.96 lb-ft, CSTB-3 = 1.70 lb-ft, CSTB-4 = 2.58 lb-ft, CSTB-5 = 3.69 lb-ft

Reference pages: Inserts → **J088 - J089**  
Standard cutting conditions → **J090**

# TDX-F L/D=5

Indexable drill, L/D = 5, flat shank

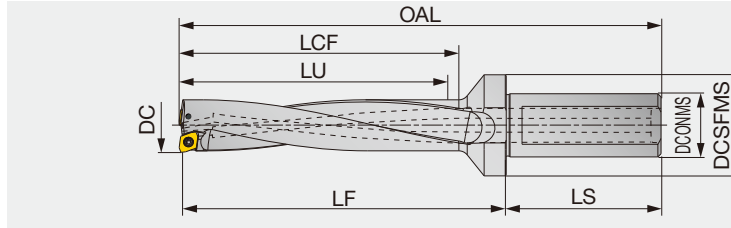

Metric	DC	DCONMS	DCSFMS	LU	LS	LCF	LF	OAL	Max. offset (radial)	WT(kg)	Insert
TDX125F20-5	12.5	20	25	62.9	49	65.9	78.5	127.9	0.8	0.2	XPMT040104R-D*
TDX130F20-5	13	20	25	65.4	49	68.4	81	130.4	0.7	0.2	XPMT040104R-D*
TDX135F20-5	13.5	20	25	67.9	49	70.9	83.5	132.9	0.6	0.2	XPMT040104R-D*
TDX140F20-5	14	20	25	70.4	49	73.4	86	135.4	0.5	0.2	XPMT040104R-D*
TDX145F20-5	14.5	20	25	72.9	49	75.9	89.5	138.9	0.4	0.2	XPMT040104R-D*
TDX150F20-5	15	20	25	75.4	49	78.4	92	141.4	0.9	0.2	XPMT050204R-D*
TDX155F20-5	15.5	20	32	77.9	49	80.9	94.5	143.9	0.8	0.2	XPMT050204R-D*
TDX160F20-5	16	20	32	80.4	49	83.4	98	147.4	0.6	0.2	XPMT050204R-D*
TDX165F20-5	16.5	20	32	82.9	49	85.9	100.5	149.9	0.5	0.2	XPMT050204R-D*
TDX170F20-5	17	20	32	85.4	49	88.4	103	152.4	0.4	0.2	XPMT050204R-D*
TDX175F25-5	17.5	25	32	88	54	91	106.5	161	1.2	0.3	XPMT06X308R-D*
TDX180F25-5	18	25	32	90.5	54	93.5	109	163.5	1.1	0.3	XPMT06X308R-D*
TDX185F25-5	18.5	25	32	93	54	96	111.5	166	0.9	0.4	XPMT06X308R-D*
TDX190F25-5	19	25	32	95.5	54	98.5	114	168.5	0.8	0.4	XPMT06X308R-D*
TDX195F25-5	19.5	25	32	98	54	101	118.5	173	0.7	0.4	XPMT06X308R-D*
TDX200F25-5	20	25	32	100.5	54	104.5	121	175.5	0.5	0.4	XPMT06X308R-D*
TDX205F25-5	20.5	25	32	103	54	107	123.5	178	0.4	0.4	XPMT06X308R-D*
TDX210F25-5	21	25	32	105.5	54	109.5	126	180.5	0.3	0.4	XPMT06X308R-D*
TDX215F25-5	21.5	25	32	108	54	112	128.5	183	0.2	0.4	XPMT06X308R-D*
TDX220F25-5	22	25	32	110.6	54	114.6	131	185.6	1.2	0.6	XPMT07H308R-D*
TDX225F25-5	22.5	25	37	113.1	54	117.1	134	188.6	1.1	0.6	XPMT07H308R-D*
TDX230F25-5	23	25	37	115.6	54	119.6	137	191.6	0.9	0.4	XPMT07H308R-D*
TDX235F25-5	23.5	25	37	118.1	54	122.1	140	194.6	0.8	0.4	XPMT07H308R-D*
TDX240F25-5	24	25	37	120.6	54	124.6	143	197.6	0.7	0.4	XPMT07H308R-D*
TDX245F25-5	24.5	25	37	123.1	54	127.1	146	200.6	0.5	0.7	XPMT07H308R-D*
TDX250F25-5	25	25	37	125.6	54	129.6	149	203.6	0.4	0.7	XPMT07H308R-D*
TDX255F25-5	25.5	25	37	128.1	54	132.1	151.5	206.1	0.3	0.7	XPMT07H308R-D*
TDX260F25-5	26	25	37	130.6	54	134.6	154	208.6	0.2	0.7	XPMT07H308R-D*
TDX270F32-5	27	32	40	135.7	59	139.7	159	218.7	1.5	0.6	XPMT08T308R-D*
TDX280F32-5	28	32	40	140.7	59	144.7	165	224.7	1.2	0.9	XPMT08T308R-D*
TDX290F32-5	29	32	40	145.7	59	149.7	170	229.7	1	0.7	XPMT08T308R-D*
TDX300F32-5	30	32	40	150.7	59	154.7	177	236.7	0.7	1	XPMT08T308R-D*
TDX310F32-5	31	32	40	155.7	59	159.7	183	242.7	0.4	1	XPMT08T308R-D*
TDX320F32-5	32	32	40	160.7	59	164.7	188	247.7	0.2	1.1	XPMT08T308R-D*
TDX330F40-5	33	40	50	166.1	69	170.1	194	264.1	2.3	1.5	XPMT110412R-D*
TDX340F40-5	34	40	50	171.1	69	175.1	199	269.1	2.1	1.5	XPMT110412R-D*
TDX350F40-5	35	40	50	176.1	69	180.1	205	275.1	1.8	1.5	XPMT110412R-D*
TDX360F40-5	36	40	50	181.1	69	185.1	211	281.1	1.5	1.6	XPMT110412R-D*
TDX370F40-5	37	40	50	186.1	69	190.1	216	286.1	1.3	1.6	XPMT110412R-D*
TDX380F40-5	38	40	50	191.1	69	195.1	222	292.1	1	1.9	XPMT110412R-D*
TDX390F40-5	39	40	50	196.1	69	200.1	227	297.1	0.7	2	XPMT110412R-D*
TDX400F40-5	40	40	50	201.1	69	205.1	233	303.1	0.5	2	XPMT110412R-D*
TDX410F40-5	41	40	50	206.1	69	210.1	239	309.1	0.2	2.1	XPMT110412R-D*
TDX420F40-5	42	40	55	211.6	69	215.6	244	314.6	3.1	2.2	XPMT150512R-D*
TDX430F40-5	43	40	55	216.6	69	220.6	250	320.6	2.9	2.2	XPMT150512R-D*
TDX440F40-5	44	40	55	221.6	69	225.6	255	325.6	2.6	2.3	XPMT150512R-D*
TDX450F40-5	45	40	55	226.6	69	230.6	262	332.6	2.3	2.6	XPMT150512R-D*
TDX460F40-5	46	40	55	231.6	69	235.6	268	338.6	2.1	2.7	XPMT150512R-D*
TDX470F40-5	47	40	55	236.6	69	240.6	273	343.6	1.8	2.8	XPMT150512R-D*
TDX480F40-5	48	40	55	241.6	69	245.6	279	349.6	1.5	3.1	XPMT150512R-D*
TDX490F40-5	49	40	55	246.6	69	250.6	284	354.6	1.3	3.1	XPMT150512R-D*
TDX500F40-5	50	40	55	251.6	69	255.6	290	360.6	1	3.2	XPMT150512R-D*
TDX510F40-5	51	40	55	256.6	69	260.6	296	366.6	0.7	3.3	XPMT150512R-D*
TDX520F40-5	52	40	55	261.6	69	265.6	301	371.6	0.5	3.4	XPMT150512R-D*
TDX530F40-5	53	40	55	266.6	69	270.6	307	377.6	-	3.5	XPMT150512R-D*
TDX540F40-5	54	40	55	271.6	69	275.6	312	382.6	-	3.9	XPMT150512R-D*

## SPARE PARTS

Designation	Clamping screw	Wrench
TDX125 - 145	CSPB-2H	IP-6DB
TDX150 - 170	CSPB-2L043	IP-6DB
TDX175 - 215	CSPB-2.2	IP-7D
TDX220 - 260	CSPB-2.5	IP-8D
TDX270 - 320	CSTB-3	T-9D
TDX330 - 410	CSTB-4	T-15D
TDX420 - 540	CSTB-5	T-20D

Tool diameter (mm)	Tool diameter tolerance (mm)	Hole diameter tolerance (mm)*
ø12.5 - ø17	+ 0.1 / 0	+ 0.4 / 0
ø17.5 - ø54	+ 0.2 / 0	+ 0.45 / 0

\*Just for reference  
Recommended clamping torque: CSPB-2H/CSPB-2L043 = 0.7 N·m, CSPB-2.2 = 1 N·m, CSPB-2.5 = 1.3 N·m, CSTB-3 = 2.3 N·m, CSTB-4 = 3.5 N·m, CSTB-5 = 5 N·m

Reference pages: Inserts → **J088 - J089**

Standard cutting conditions → **J090**





## INSERT

### DJ

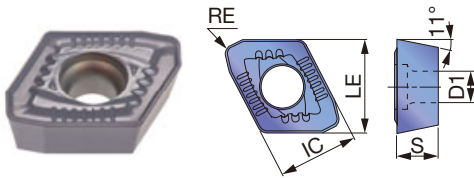

P	Steel			★	☆				
M	Stainless	☆		★					
K	Cast iron		☆	☆	★				
N	Non-ferrous	★		☆					
S	Superalloys	☆		★	☆				
H	Hard materials	☆		★	☆				

★ : First choice  
☆ : Second choice

Designation	IC (in)	LE (in)	Coated				S (in)	D1 (in)	RE (in)	DCN (in)	DCX (in)
			AH725	T1115	AH6030	AH9030					
XPMT040104R-DJ	0.169	0.177	●	●	●	●	0.063	0.091	0.016	0.492	0.571
XPMT050204R-DJ	0.205	0.213	●	●	●	●	0.094	0.091	0.016	0.591	0.669
XPMT06X308R-DJ	0.236	0.276	●	●	●	●	0.118	0.098	0.031	0.689	0.846
XPMT07H308R-DJ	0.276	0.323	●	●	●	●	0.142	0.110	0.031	0.866	1.024
XPMT08T308R-DJ	0.335	0.390	●	●	●	●	0.156	0.134	0.031	1.063	1.260
XPMT110412R-DJ	0.441	0.492	●	●	●	●	0.187	0.173	0.047	1.299	1.614
XPMT150512R-DJ	0.591	0.634	●	●	●	●	0.219	0.217	0.047	1.654	2.126

● : Line up

### DS

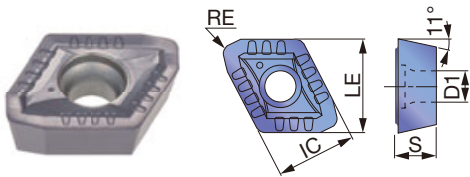

P	Steel	☆	★						
M	Stainless	☆	★						
K	Cast iron								
N	Non-ferrous	☆							
S	Superalloys	☆	★						
H	Hard materials								

★ : First choice  
☆ : Second choice

Designation	IC (in)	LE (in)	Coated		S (in)	D1 (in)	RE (in)	DCN (in)	DCX (in)
			AH725	AH6030					
XPMT040104R-DS	0.169	0.177	●	●	0.063	0.091	0.016	0.492	0.571
XPMT050204R-DS	0.205	0.213	●	●	0.094	0.091	0.016	0.591	0.669
XPMT06X308R-DS	0.236	0.276	●	●	0.118	0.098	0.031	0.689	0.846
XPMT07H308R-DS	0.276	0.323	●	●	0.142	0.110	0.031	0.866	1.024
XPMT08T308R-DS	0.335	0.390	●	●	0.156	0.134	0.031	1.063	1.260
XPMT110412R-DS	0.441	0.492	●	●	0.187	0.173	0.047	1.299	1.614
XPMT150512R-DS	0.591	0.634	●	●	0.219	0.217	0.047	1.654	2.126

● : Line up



## DW

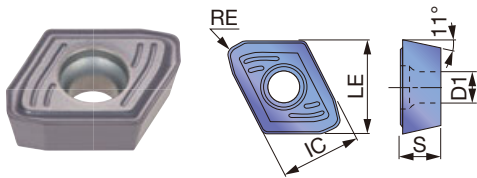

<b>P</b> Steel	☆	★	☆						
<b>M</b> Stainless	☆	★	☆						
<b>K</b> Cast iron		☆	★						
<b>N</b> Non-ferrous	☆	★							
<b>S</b> Superalloys	☆	★	☆						
<b>H</b> Hard materials	☆	★	☆						

★ : First choice  
☆ : Second choice

Designation	IC (in)	LE (in)	Coated			S (in)	D1 (in)	RE (in)	DCN (in)	DCX (in)
			AH725	AH6030	AH9030					
XPMT040104R-DW	0.169	0.177	●	●	●	0.063	0.091	0.016	0.492	0.571
XPMT050204R-DW	0.205	0.213	●	●	●	0.094	0.091	0.016	0.591	0.669
XPMT06X308R-DW	0.236	0.276	●	●	●	0.118	0.098	0.031	0.689	0.846
XPMT07H308R-DW	0.276	0.323	●	●	●	0.142	0.110	0.031	0.866	1.024
XPMT08T308R-DW	0.335	0.390	●	●	●	0.156	0.134	0.031	1.063	1.260
XPMT110412R-DW	0.441	0.492	●	●	●	0.187	0.173	0.047	1.299	1.614
XPMT150512R-DW	0.591	0.634	●	●	●	0.219	0.217	0.047	1.654	2.126

● : Line up

## DG

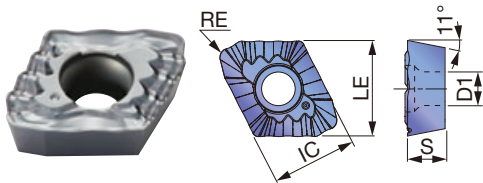

<b>P</b> Steel	★								
<b>M</b> Stainless	☆								
<b>K</b> Cast iron									
<b>N</b> Non-ferrous	★								
<b>S</b> Superalloys	☆								
<b>H</b> Hard materials									

★ : First choice  
☆ : Second choice

Designation	IC (in)	LE (in)	Coated			S (in)	D1 (in)	RE (in)	DCN (in)	DCX (in)
			AH725							
XPMT08T308R-DG	0.335	0.390	●			0.156	0.134	0.031	1.063	1.260
XPMT110412R-DG	0.441	0.492	●			0.187	0.173	0.047	1.299	1.614
XPMT150512R-DG	0.591	0.634	●			0.219	0.217	0.047	1.654	2.126

● : Line up



## RECOMMENDED INSERT

ISO	Workpiece material	Hardness	First choice	High feed	High speed	Troubleshooting			
						Chipping resistance	Wear resistance	Surface finish	Chip control
P	Low carbon steels (C ≤ 0.3%)	- 200 HB	DS, AH6030	-	-	DS, AH725	-	DW, AH6030	DG, AH725
	Carbon steels (C > 0.3%) Alloy steels	- 300 HB	DJ, AH6030	DW, AH6030	DJ, AH9030	DW, AH725	DJ, AH9030	DW, AH6030	-
M	Low alloy steels	- 200 HB	DS, AH6030	-	-	DS, AH725	-	DW, AH6030	-
	Stainless steel	- 200 HB	DS, AH6030	-	-	DS, AH725	-	DW, AH6030	DG, AH725
K	Gray cast irons	150 - 250 HB	DJ, AH9030	DW, AH9030	DJ, T1115	DW, AH725	-	DW, AH9030	-
	Ductile cast irons	150 - 250 HB	DJ, AH9030	DW, AH9030	-	DW, AH725	-	DW, AH9030	-
N	Aluminum alloy	-	DJ, AH725	DW, AH725	DS, AH6030	-	-	DW, AH725	DG, AH725
S	Titanium alloys Heat-resistant alloys	- 40 HRC	DS, AH6030	-	-	DW, AH725	-	DW, AH725	DG, AH725
H	Hardened steel	- 50 HRC	DJ, AH9030	DW, AH9030	-	DW, AH725	-	DW, AH9030	-

## STANDARD CUTTING CONDITIONS

ISO	Workpiece material	Hardness	Cutting speed Vc (sfm)	Series L/D	Feed: f (ipr)				
					ø0.492" ~ ø0.571"	ø0.591" ~ ø0.669"	ø0.689" ~ ø1.024"	ø1.063" ~ ø1.260"	ø1.299" ~ ø2.126"
P	Low carbon steels (C < 0.3) 1018, 1026, etc.	- 200 HB	525 - 1050	2D, 3D	0.0008 - 0.0024	0.0008 - 0.0024	0.0016 - 0.0039	0.0016 - 0.0039	0.0016 - 0.0039
				4D, 5D	0.0008 - 0.0024	0.0008 - 0.0024	0.0016 - 0.0039	0.0016 - 0.0039	0.0016 - 0.0039
	Carbon steels (C > 0.3) 1045, 1055, etc.	- 300 HB	262 - 820	2D, 3D	0.0016 - 0.0039	0.0016 - 0.0047	0.0024 - 0.0051	0.0024 - 0.0059	0.0031 - 0.0071
				4D, 5D	0.0016 - 0.0031	0.0016 - 0.0031	0.0024 - 0.0039	0.0024 - 0.0047	0.0031 - 0.0055
M	Low alloy steels 4130, etc.	- 200 HB	525 - 820	2D, 3D	0.0016 - 0.0031	0.0016 - 0.0031	0.0024 - 0.0047	0.0024 - 0.0047	0.0024 - 0.0055
				4D, 5D	0.0016 - 0.0031	0.0016 - 0.0031	0.0024 - 0.0047	0.0024 - 0.0047	0.0024 - 0.0055
	Alloy steels 4140, 5120, etc.	- 300 HB	262 - 656	2D, 3D	0.0016 - 0.0039	0.0016 - 0.0047	0.0024 - 0.0051	0.0024 - 0.0059	0.0031 - 0.0071
				4D, 5D	0.0016 - 0.0031	0.0016 - 0.0031	0.0024 - 0.0039	0.0024 - 0.0047	0.0031 - 0.0055
K	Stainless steels (Austenitic) 304, 316, etc.	- 200 HB	328 - 656	2D, 3D	0.0008 - 0.0031	0.0008 - 0.0031	0.0016 - 0.0039	0.0016 - 0.0047	0.0016 - 0.0047
				4D, 5D	0.0008 - 0.0031	0.0008 - 0.0031	0.0016 - 0.0039	0.0016 - 0.0047	0.0016 - 0.0047
	Stainless steels (Martensitic and ferritic) 430, 416, etc.	- 200 HB	328 - 722	2D, 3D	0.0008 - 0.0031	0.0008 - 0.0031	0.0016 - 0.0039	0.0016 - 0.0047	0.0016 - 0.0047
				4D, 5D	0.0008 - 0.0031	0.0008 - 0.0031	0.0016 - 0.0039	0.0016 - 0.0047	0.0016 - 0.0047
N	Stainless steels (Precipitation hardening) 630, etc.	-	262 - 394	2D, 3D	0.0016 - 0.0031	0.0016 - 0.0031	0.0016 - 0.0031	0.0016 - 0.0039	0.0024 - 0.0039
				4D, 5D	0.0016 - 0.0031	0.0016 - 0.0031	0.0016 - 0.0031	0.0016 - 0.0039	0.0024 - 0.0039
	Gray cast irons Class 25, Class 30, etc.	150 - 250 HB	262 - 820	2D, 3D	0.0024 - 0.0047	0.0024 - 0.0047	0.0024 - 0.0059	0.0024 - 0.0071	0.0031 - 0.0079
				4D, 5D	0.0024 - 0.0039	0.0024 - 0.0039	0.0024 - 0.0047	0.0024 - 0.0055	0.0031 - 0.0063
S	Ductile cast irons 60-40-18, etc.	150 - 250 HB	262 - 656	2D, 3D	0.0016 - 0.0047	0.0016 - 0.0047	0.0024 - 0.0059	0.0024 - 0.0071	0.0031 - 0.0079
				4D, 5D	0.0016 - 0.0039	0.0016 - 0.0039	0.0024 - 0.0047	0.0024 - 0.0055	0.0031 - 0.0063
	Aluminum alloy 333.0, 383.0, etc.	-	656 - 1312	2D, 3D	0.0039 - 0.0047	0.0039 - 0.0059	0.0059 - 0.0079	0.0059 - 0.0079	0.0059 - 0.0098
				4D, 5D	0.0031 - 0.0047	0.0031 - 0.0047	0.0047 - 0.0063	0.0047 - 0.0063	0.0047 - 0.0079
H	Heat-resistant alloys Inconel 718, etc.	- 40 HRC	66 - 197	2D, 3D	0.0016 - 0.0031	0.0016 - 0.0031	0.0016 - 0.0039	0.0016 - 0.0039	0.0016 - 0.0039
				4D, 5D	0.0016 - 0.0031	0.0016 - 0.0031	0.0016 - 0.0039	0.0016 - 0.0039	0.0016 - 0.0039
	Titanium alloys Ti-6Al-4V, etc.	- 40 HRC	131 - 394	2D, 3D	0.0024 - 0.0039	0.0024 - 0.0039	0.0024 - 0.0047	0.0024 - 0.0047	0.0024 - 0.0047
				4D, 5D	0.0024 - 0.0031	0.0024 - 0.0031	0.0024 - 0.0039	0.0024 - 0.0039	0.0024 - 0.0039
Hardened steel ≥ 40HRC	- 50 HRC	131 - 328	2D, 3D	0.0016 - 0.0031	0.0016 - 0.0031	0.0016 - 0.0039	0.0016 - 0.0039	0.0016 - 0.0039	
			4D, 5D	0.0016 - 0.0031	0.0016 - 0.0031	0.0016 - 0.0031	0.0016 - 0.0031	0.0016 - 0.0031	

## STANDARD CUTTING CONDITIONS FOR DG TYPE CHIPBREAKER

ISO	Workpiece material	Hardness	Cutting speed Vc (sfm)	Series L/D	Feed: f (ipr)	
					ø1.063" ~ ø1.260"	ø1.299" ~ ø2.126"
P	Low carbon steels (C < 0.3) 1018, 1026, etc.	- 200 HB	260 - 590	2D, 3D 4D, 5D	0.0016 - 0.0039	

- When using the smaller side of the diameter range, the feed rate should be set lower.
- When using DW insert for work materials of 40 HRC, the feed rate should be set below 50%.
- For difficult-to-cut materials (heat-resistant alloys, etc.), the cutting speed should be set 25% below that of carbon steels.
- High speed machining means cutting speeds over 150 m/min.
- For high-feed machining, apply a feed rate that is approximately 1.5 times the standard feed conditions.
- When using DW insert for troubleshooting, use it within the range of standard cutting conditions.
- DG type chipbreaker is suitable for heavy machines that have low-rpm spindles. If chatter occurs, a lower feed rate is recommended.

# TUNGDRILLTWISTED

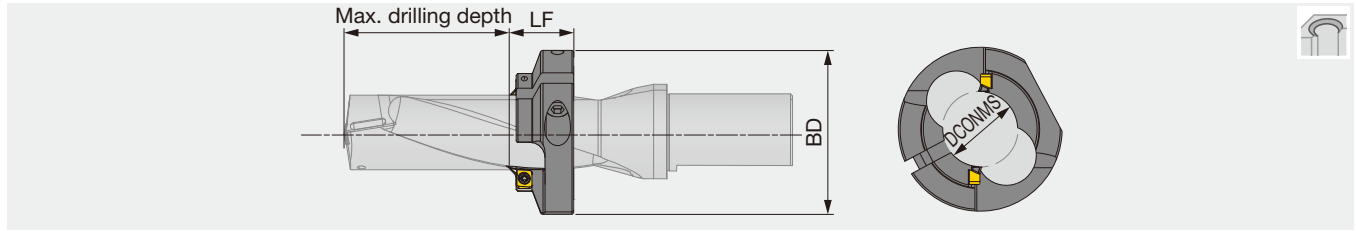

## TDXCF chamfering tool

Chamfering tool for TungDrillTwisted and TungSix-Drill



Inch	DCONMS	BD	LF	Application drill	Max. drilling depth			
					L/D = 2	L/D = 3	L/D = 4	L/D = 5
TDXCF150L25	0.681	1.929	0.984	TDX175*25-*	0.512	1.201	1.890	2.579
TDXCF160L25	0.681	1.929	0.984	TDX180*25-*	0.551	1.260	1.969	2.677
TDXCF180L25	0.713	1.929	0.984	TDX185*25-*	0.591	1.319	2.047	2.776
TDXCF190L25	0.713	1.929	0.984	TDX190*25-*	0.630	1.378	2.126	2.874
TDXCF210L25	0.752	1.929	0.984	TDX195*25-*	0.669	1.437	2.205	2.972
TDXCF230L25	0.752	1.929	0.984	TDX200*25-*	0.787	1.575	2.323	3.110
TDXCF240L25	0.791	1.929	0.984	TDX205*25-*	0.827	1.634	2.402	3.209
TDXCF260L30	0.791	1.929	0.984	TDX210*25-*	0.866	1.693	2.480	3.307
TDXCF270L30	0.831	1.929	0.984	TDX215*25-*	0.906	1.752	2.559	3.406
TDXCF290L30	0.831	1.929	0.984	TDX220*25-*	0.945	1.811	2.638	3.504
TDXCF300L30	0.870	1.929	0.984	TDX225*25-*	0.984	1.870	2.717	3.602
TDXCF320L30	0.870	1.929	0.984	TDX230*25-*	1.024	1.929	2.795	3.701
TDXCF340L30	0.909	1.929	0.984	TDX235*25-*	1.063	1.988	2.874	3.799
TDXCF350L30	0.909	1.929	0.984	TDX240*25-*	1.102	2.047	2.953	3.898
TDXCF370L30	0.943	1.929	0.984	TDX245*25-*	1.142	2.106	3.031	3.996
TDXCF380L30	0.943	1.929	0.984	TDX250*25-*	1.181	2.165	3.110	4.094
TDXCF400L30	0.982	2.520	1.181	TDX255*25-*	1.024	2.028	2.992	3.996
TDXCF410L30	0.982	2.520	1.181	TDX260*25-*	1.063	2.087	3.071	4.094
TDXCF430L30	1.020	2.520	1.181	TDX270*32-*	1.142	2.205	3.228	4.291
TDXCF450L30	1.059	2.520	1.181	TDX280*32-*	1.193	2.295	3.386	4.488
TDXCF460L30	1.098	2.520	1.181	TDX290*32-*	1.272	2.413	3.543	4.685
TDXCF480L30	1.138	2.520	1.181	TDX300*32-*	1.350	2.531	3.701	4.882
TDXCF500L30	1.177	2.520	1.181	TDX310*32-*	1.429	2.650	3.858	5.079
TDXCF510L30	1.217	2.520	1.181	TDX320*32-*	1.508	2.768	4.016	5.276

### SPARE PARTS

Designation	 Screw for insert	 Screw for ring	 Wrench for insert	 Wrench for ring
TDXCF130 - 250	CSPB-4S	CM6X16	IP-15D	P-5
TDXCF260 - 540	CSPB-4S	CM8X1.25X20-A	IP-15D	P-6

Recommended clamping torque: CSPB-4S = 2.58 lb-ft

Grade  
Insert  
Ext. Toolholder  
Int. Toolholder  
Threading  
Grooving  
Miniature tool  
Milling cutter  
Endmill  
Drilling tool  
Tooling System  
User's Guide  
Index



# TUNGDRILLTWISTED

## TDXCF chamfering tool

Chamfering tool for TungDrillTwisted and TungSix-Drill

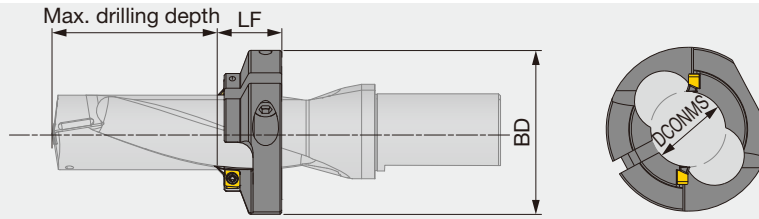

Metric	DCONMS	BD	LF	Application drill	Max. drilling depth			
					L/D = 2	L/D = 3	L/D = 4	L/D = 5
TDXCF180L25	17.3	49	25	TDX175*25-*	13	30.5	48	65.5
TDXCF180L25	17.3	49	25	TDX180*25-*	14	32	50	68
TDXCF190L25	18.1	49	25	TDX185*25-*	15	33.5	52	70.5
TDXCF190L25	18.1	49	25	TDX190*25-*	16	35	54	73
TDXCF200L25	19.1	49	25	TDX195*25-*	17	36.5	56	75.5
TDXCF200L25	19.1	49	25	TDX200*25-*	20	40	59	79
TDXCF210L25	20.1	49	25	TDX205*25-*	21	41.5	61	81.5
TDXCF210L25	20.1	49	25	TDX210*25-*	22	43	63	84
TDXCF220L25	21.1	49	25	TDX215*25-*	23	44.5	65	86.5
TDXCF220L25	21.1	49	25	TDX220*25-*	24	46	67	89
TDXCF230L25	22.1	49	25	TDX225*25-*	25	47.5	69	91.5
TDXCF230L25	22.1	49	25	TDX230*25-*	26	49	71	94
TDXCF240L25	23.1	49	25	TDX235*25-*	27	50.5	73	96.5
TDXCF240L25	23.1	49	25	TDX240*25-*	28	52	75	99
TDXCF250L25	23.95	49	25	TDX245*25-*	29	53.5	77	101.5
TDXCF250L25	23.95	49	25	TDX250*25-*	30	55	79	104
TDXCF260L30	24.95	64	30	TDX255*25-*	26	51.5	76	101.5
TDXCF260L30	24.95	64	30	TDX260*25-*	27	53	78	104
TDXCF270L30	25.9	64	30	TDX270*32-*	29	56	82	109
TDXCF280L30	26.9	64	30	TDX280*32-*	30.3	58.3	86	114
TDXCF290L30	27.9	64	30	TDX290*32-*	32.3	61.3	90	119
TDXCF300L30	28.9	64	30	TDX300*32-*	34.3	64.3	94	124
TDXCF310L30	29.9	64	30	TDX310*32-*	36.3	67.3	98	129
TDXCF320L30	30.9	64	30	TDX320*32-*	38.3	70.3	102	134

### SPARE PARTS

Designation	Screw for insert	Screw for ring	Wrench for insert	Wrench for ring
TDXCF180... - TDXCF250...	CSPB-4S	CM6X16	IP-15D	P-5
TDXCF260... - TDXCF320...	CSPB-4S	CM8X1.25X20-A	IP-15D	P-6

Recommended clamping torque: CSPB-4S = 3.5 N·m

## INSERT

### XHGX-45A

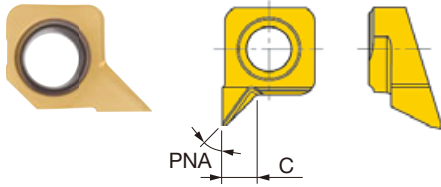

P	Steel	★							
M	Stainless	★							
K	Cast iron	★							
N	Non-ferrous	☆							
S	Superalloys	★							
H	Hard materials	★							

★ : First choice  
☆ : Second choice

Designation	PNA	C (in)	Coated								
			GH130								
XHGX090700R-45A	45°	0.098	●								

● : Line up

### Caution in mounting the chamfering tool on the drill body

- Place the ring on the drill body and match the positions of flutes on drill and ring. Temporarily clamp the ring with the ring screw tightened lightly.
- Place the inserts, and tighten the insert screw lightly.
- Adjust the ring position with a presetter, height gauge, or vernier caliper, and securely tighten the ring screw, then the insert screw.

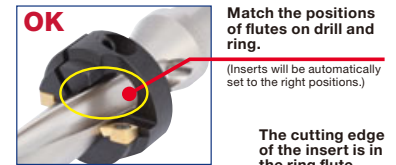

The cutting edge of the insert is in the ring flute.

## EZ sleeve

Eccentric sleeve for TungDrillTwisted and TungSix-Drill

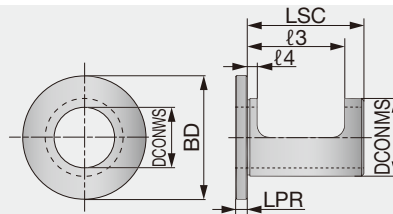

Inch	DCONWS	DCONMS	BD	LSC	LPR	l3	l4	Hole diameter adjustment	Cutting edge height adjustment
EZ0.75-1.25	0.750	1.250	1.750	2.000	0.200	1.575	0.375	+0.016 ~ - 0.008	+0.008 ~ - 0.006
EZ1.00-1.50	1.000	1.500	2.000	2.500	0.200	1.965	0.375	+0.016 ~ - 0.008	+0.008 ~ - 0.006
EZ1.25-2.00	1.250	2.000	2.500	2.700	0.200	1.965	0.375	+0.016 ~ - 0.008	+0.008 ~ - 0.006
EZ1.50-2.00	1.500	2.000	2.750	2.900	0.200	1.965	0.375	+0.024 ~ - 0.008	+0.012 ~ - 0.008
Metric	DCONWS	DCONMS	BD	LSC	LPR	l3	l4	Hole diameter adjustment	Cutting edge height adjustment
EZ2025	20	25	46	49	5	32.5	4	+0.4 ~ - 0.2	+0.2 ~ - 0.15
EZ2532	25	32	51	52	5	38	4	+0.4 ~ - 0.2	+0.2 ~ - 0.15
EZ3240	32	40	54	62	5	43	4	+0.4 ~ - 0.2	+0.2 ~ - 0.15
EZ4050	40	50	69	63	5	55	4	+0.6 ~ - 0.2	+0.3 ~ - 0.2

### SPARE PARTS

Designation	Wrench
EZ...	P-2.5

# TUNGDRILLBIG

## TDBU, TDS cartridge set

Indexable drill, L/D = 2.5, with tool diameter adjustability

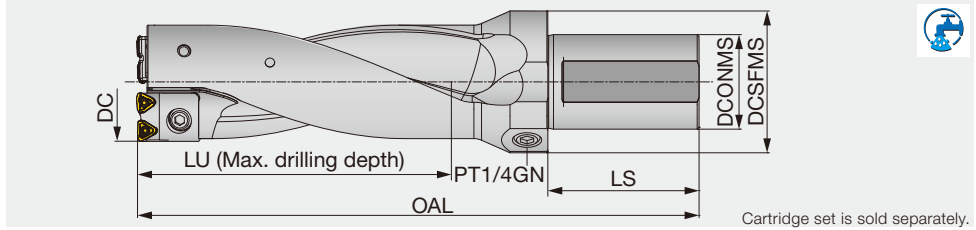

Cartridge set is sold separately.

Body	Cartridge set*	DC	DCONMS	DCSFMS	LU	LS	OAL	WT(lb)	Setting plate		Insert
									Designation	Thickness	
TDBU2250-2447-2.5	TDSCA57-62	2.250	2.000	2.953	6.117	4.000	11.957	8.800	-	-	WWMU08X408R-D*
TDBU2250-2447-2.5	TDSCA57-62	2.289	2.000	2.953	6.117	4.000	11.957	8.800	AP0801	0.020	WWMU08X408R-D*
TDBU2250-2447-2.5	TDSCA57-62	2.329	2.000	2.953	6.117	4.000	11.957	8.800	AP0802	0.039	WWMU08X408R-D*
TDBU2250-2447-2.5	TDSCA57-62	2.368	2.000	2.953	6.117	4.000	11.957	8.800	AP0803	0.059	WWMU08X408R-D*
TDBU2250-2447-2.5	TDSCA57-62	2.407	2.000	2.953	6.117	4.000	11.957	8.800	AP0804	0.079	WWMU08X408R-D*
TDBU2250-2447-2.5	TDSCA57-62	2.447**	2.000	2.953	6.117	4.000	11.957	8.800	AP0805	0.098	WWMU08X408R-D*
TDBU2461-2579-2.5	TDSCA63-66	2.461	2.000	2.953	6.447	4.000	12.567	10.100	-	-	WWMU08X408R-D*
TDBU2461-2579-2.5	TDSCA63-66	2.500	2.000	2.953	6.447	4.000	12.567	10.100	AP0801	0.020	WWMU08X408R-D*
TDBU2461-2579-2.5	TDSCA63-66	2.539	2.000	2.953	6.447	4.000	12.567	10.100	AP0802	0.039	WWMU08X408R-D*
TDBU2461-2579-2.5	TDSCA63-66	2.579**	2.000	2.953	6.447	4.000	12.567	10.100	AP0803	0.059	WWMU08X408R-D*
TDBU2632-2868-2.5	TDSCA67-73	2.632	2.000	2.953	7.170	4.000	13.544	11.900	-	-	WWMU09X510R-D*
TDBU2632-2868-2.5	TDSCA67-73	2.671	2.000	2.953	7.170	4.000	13.544	11.900	AP1101	0.020	WWMU09X510R-D*
TDBU2632-2868-2.5	TDSCA67-73	2.711	2.000	2.953	7.170	4.000	13.544	11.900	AP1102	0.039	WWMU09X510R-D*
TDBU2632-2868-2.5	TDSCA67-73	2.750	2.000	2.953	7.170	4.000	13.544	11.900	AP1103	0.059	WWMU09X510R-D*
TDBU2632-2868-2.5	TDSCA67-73	2.789	2.000	2.953	7.170	4.000	13.544	11.900	AP1104	0.079	WWMU09X510R-D*
TDBU2632-2868-2.5	TDSCA67-73	2.829	2.000	2.953	7.170	4.000	13.544	11.900	AP1105	0.098	WWMU09X510R-D*
TDBU2632-2868-2.5	TDSCA67-73	2.868**	2.000	2.953	7.170	4.000	13.544	11.900	AP1106	0.118	WWMU09X510R-D*
TDBU2921-3157-2.5	TDSCA74-80	2.921	2.000	2.953	7.894	4.000	13.973	13.700	-	-	WWMU11X512R-D*
TDBU2921-3157-2.5	TDSCA74-80	2.961	2.000	2.953	7.894	4.000	13.973	13.700	AP1101	0.020	WWMU11X512R-D*
TDBU2921-3157-2.5	TDSCA74-80	3.000	2.000	2.953	7.894	4.000	13.973	13.700	AP1102	0.039	WWMU11X512R-D*
TDBU2921-3157-2.5	TDSCA74-80	3.039	2.000	2.953	7.894	4.000	13.973	13.700	AP1103	0.059	WWMU11X512R-D*
TDBU2921-3157-2.5	TDSCA74-80	3.079	2.000	2.953	7.894	4.000	13.973	13.700	AP1104	0.079	WWMU11X512R-D*
TDBU2921-3157-2.5	TDSCA74-80	3.118	2.000	2.953	7.894	4.000	13.973	13.700	AP1105	0.098	WWMU11X512R-D*
TDBU2921-3157-2.5	TDSCA74-80	3.157**	2.000	2.953	7.894	4.000	13.973	13.700	AP1106	0.118	WWMU11X512R-D*

\*Cartridge set is sold separately

\*\* - max diameter that can be achieved with this drill body

### Body SPARE PARTS

Designation	① Setting plate screw	Plug Screw	② Cartridge screw	③ Setting plate 1	③ Setting plate 2	③ Setting plate 3	③ Setting plate 4	③ Setting plate 5	③ Setting plate 6	Wrench for setting plate	Wrench for cartridge	Wrench for plug	④ Washer
TDBU2250-2447-2.5	CSTB-3	PT1/4GN	CM5X0.8X12	AP0801	AP0802	AP0803	AP0804	AP0805	-	T-9D	P-4	P-6	5.3X10X1
TDBU2461-2579-2.5	CSTB-3	PT1/4GN	CHHM6-15	AP0801	AP0802	AP0803	-	-	-	T-9D	P-5	P-6	6.4X12.5X1.6
TDBU2632-2868-2.5	CSTB-3	PT1/4GN	CM6X16	AP1101	AP1102	AP1103	AP1104	AP1105	AP1106	T-9D	P-5	P-6	6.4X12.5X1.6
TDBU2921-3157-2.5	CSTB-3	PT1/4GN	CM6X16	AP1101	AP1102	AP1103	AP1104	AP1105	AP1106	T-9D	P-5	P-6	6.4X12.5X1.6

### Cartridge set SPARE PARTS

Designation	⑤ Insert screw	Wrench
TDSCA57-62	CSTB-3	T-9F
TDSCA63-66	CSTB-3	T-9F
TDSCA67-73	CSTB-4	T-15F
TDSCA74-80	CSTB-5	T-20F

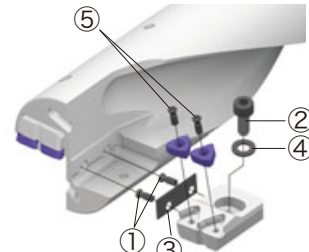

### Cartridge SPARE PARTS

Designation	Insert screw (x2)	Setting plate screw
TDS08CA-C-57-62	CSTB-3	-
TDS08CA-C-63-66	CSTB-3	-
TDS09CA-C-67-73	CSTB-4	-
TDS11CA-C-74-80	CSTB-5	-

### SPARE PARTS

Designation	Insert screw (x2)	Setting plate screw (x2)
TDS08CA-P-57-62	CSTB-3	CSTB-3
TDS08CA-P-63-66	CSTB-3	CSTB-3
TDS09CA-P-67-73	CSTB-4	CSTB-3
TDS11CA-P-74-80	CSTB-5	CSTB-3

Recommended clamping torque: CSTB-3 = 1.70 lb-ft, CSTB-4 = 2.58 lb-ft, CSTB-5 = 3.69 lb-ft

Reference pages: Inserts → **J096**, Standard cutting conditions → **J097**



# TDB, TDS cartridge set

Indexable drill, L/D = 2.5, with tool diameter adjustability

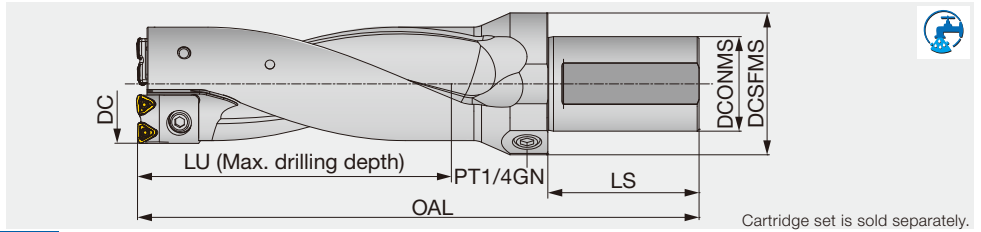

Cartridge set is sold separately.

Body	Cartridge set*	DC	DCONMS	DCSFMS	LU	LS	OAL	WT(kg)	Setting plate Designation	Setting plate Thickness (mm)	Insert
TDB55-56F50-2.5	TDSCA55-56	55	50	75	140	80	262	3.2	-	-	WWMU08X408R-D*
TDB55-56F50-2.5	TDSCA55-56	56	50	75	140	80	262	3.2	AP0801	0.5	WWMU08X408R-D*
TDB57-62F50-2.5	TDSCA57-62	57	50	75	155	80	282	3.6	-	-	WWMU08X408R-D*
TDB57-62F50-2.5	TDSCA57-62	58	50	75	155	80	282	3.6	AP0801	0.5	WWMU08X408R-D*
TDB57-62F50-2.5	TDSCA57-62	59	50	75	155	80	282	3.6	AP0802	1	WWMU08X408R-D*
TDB57-62F50-2.5	TDSCA57-62	60	50	75	155	80	282	3.6	AP0803	1.5	WWMU08X408R-D*
TDB57-62F50-2.5	TDSCA57-62	61	50	75	155	80	282	3.6	AP0804	2	WWMU08X408R-D*
TDB57-62F50-2.5	TDSCA57-62	62**	50	75	155	80	282	3.6	AP0805	2.5	WWMU08X408R-D*
TDB63-66F50-2.5	TDSCA63-66	63	50	75	165	80	297	4.2	-	-	WWMU08X408R-D*
TDB63-66F50-2.5	TDSCA63-66	64	50	75	165	80	297	4.2	AP0801	0.5	WWMU08X408R-D*
TDB63-66F50-2.5	TDSCA63-66	65	50	75	165	80	297	4.2	AP0802	1	WWMU08X408R-D*
TDB63-66F50-2.5	TDSCA63-66	66**	50	75	165	80	297	4.2	AP0803	1.5	WWMU08X408R-D*
TDB67-73F50-2.5	TDSCA67-73	67	50	75	183	80	322	5	-	-	WWMU09X510R-D*
TDB67-73F50-2.5	TDSCA67-73	68	50	75	183	80	322	5	AP1101	0.5	WWMU09X510R-D*
TDB67-73F50-2.5	TDSCA67-73	69	50	75	183	80	322	5	AP1102	1	WWMU09X510R-D*
TDB67-73F50-2.5	TDSCA67-73	70	50	75	183	80	322	5	AP1103	1.5	WWMU09X510R-D*
TDB67-73F50-2.5	TDSCA67-73	71	50	75	183	80	322	5	AP1104	2	WWMU09X510R-D*
TDB67-73F50-2.5	TDSCA67-73	72	50	75	183	80	322	5	AP1105	2.5	WWMU09X510R-D*
TDB67-73F50-2.5	TDSCA67-73	73**	50	75	183	80	322	5	AP1106	3	WWMU09X510R-D*
TDB74-80F50-2.5	TDSCA74-80	74	50	75	200	80	333	5.7	-	-	WWMU11X512R-D*
TDB74-80F50-2.5	TDSCA74-80	75	50	75	200	80	333	5.7	AP1101	0.5	WWMU11X512R-D*
TDB74-80F50-2.5	TDSCA74-80	76	50	75	200	80	333	5.7	AP1102	1	WWMU11X512R-D*
TDB74-80F50-2.5	TDSCA74-80	77	50	75	200	80	333	5.7	AP1103	1.5	WWMU11X512R-D*
TDB74-80F50-2.5	TDSCA74-80	78	50	75	200	80	333	5.7	AP1104	2	WWMU11X512R-D*
TDB74-80F50-2.5	TDSCA74-80	79	50	75	200	80	333	5.7	AP1105	2.5	WWMU11X512R-D*
TDB74-80F50-2.5	TDSCA74-80	80**	50	75	200	80	333	5.7	AP1106	3	WWMU11X512R-D*

\*Cartridge set is sold separately

\*\* max drill diameter that can be achieved with this drill body

## Body SPARE PARTS



Designation	① Setting plate screw	Plug Screw	② Cartridge screw	③ Setting plate 1	③ Setting plate 2	③ Setting plate 3	③ Setting plate 4	③ Setting plate 5	③ Setting plate 6	Wrench for setting plate	Wrench for cartridge	Wrench for plug	④ Washer
TDB55-56F50-2.5	CSTB-3	PT1/4GN	CM5X0.8X12	AP0801	-	-	-	-	-	T-9D	P-4	P-6	5.3X10X1
TDB57-62F50-2.5	CSTB-3	PT1/4GN	CM5X0.8X12	AP0801	AP0802	AP0803	AP0804	AP0805	-	T-9D	P-4	P-6	5.3X10X1
TDB63-66F50-2.5	CSTB-3	PT1/4GN	CHHM6-15	AP0801	AP0802	AP0803	-	-	-	T-9D	P-5	P-6	6.4X12.5X1.6
TDB67-73F50-2.5	CSTB-3	PT1/4GN	CM6X16	AP1101	AP1102	AP1103	AP1104	AP1105	AP1106	T-9D	P-5	P-6	6.4X12.5X1.6
TDB74-80F50-2.5	CSTB-3	PT1/4GN	CM6X16	AP1101	AP1102	AP1103	AP1104	AP1105	AP1106	T-9D	P-5	P-6	6.4X12.5X1.6

## Cartridge set SPARE PARTS



Designation	⑤ Insert screw	Wrench
TDSCA55 - 56	CSTB-3	T-9F
TDSCA57 - 62	CSTB-3	T-9F
TDSCA63 - 66	CSTB-3	T-9F
TDSCA67 - 73	CSTB-4	T-15F
TDSCA74 - 80	CSTB-5	T-20F

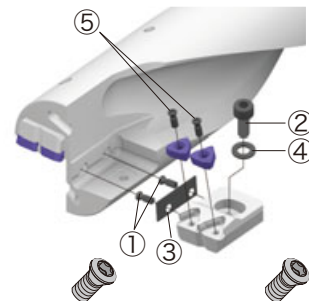

## Cartridge SPARE PARTS



Designation	Insert screw (x2)	Setting plate screw
TDS08CA-C-55-56	CSTB-3	-
TDS08CA-C-57-62	CSTB-3	-
TDS08CA-C-63-66	CSTB-3	-
TDS09CA-C-67-73	CSTB-4	-
TDS11CA-C-74-80	CSTB-5	-

## SPARE PARTS

Designation	Insert screw (x2)	Setting plate screw (x2)
TDS08CA-P-55-56	CSTB-3	CSTB-3
TDS08CA-P-57-62	CSTB-3	CSTB-3
TDS08CA-P-63-66	CSTB-3	CSTB-3
TDS09CA-P-67-73	CSTB-4	CSTB-3
TDS11CA-P-74-80	CSTB-5	CSTB-3

Recommended clamping torque: CSTB-3 = 2.3 N·m, CSTB-4 = 3.5 N·m, CSTB-5 = 5 N·m

Reference pages: Inserts → J096, Standard cutting conditions → J097



## INSERT

### DJ

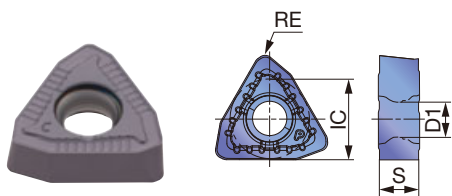

P	Steel	☆	★							
M	Stainless	★	☆							
K	Cast iron	☆	★							
N	Non-ferrous	★	☆							
S	Superalloys	★	☆							
H	Hard materials	★	☆							

★ : First choice  
☆ : Second choice

Designation	IC (in)	S (in)	Coated								D1 (in)	RE (in)	DCN (in)	DCX (in)	
			AH3135	AH9030											
WWMU08X408R-DJ	0.315	0.154	●	●								0.134	0.031	2.165	2.598
WWMU09X510R-DJ	0.382	0.193	●	●								0.173	0.039	2.638	2.874
WWMU11X512R-DJ	0.445	0.224	●	●								0.217	0.047	2.913	3.150

● : Line up

### DS

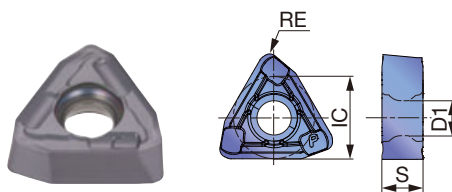

P	Steel	★								
M	Stainless	★								
K	Cast iron									
N	Non-ferrous									
S	Superalloys	★								
H	Hard materials									

★ : First choice  
☆ : Second choice

Designation	IC (in)	S (in)	Coated								D1 (in)	RE (in)	DCN (in)	DCX (in)	
			AH6030												
WWMU08X408R-DS	0.315	0.154	●									0.134	0.031	2.165	2.598
WWMU09X510R-DS	0.382	0.193	●									0.173	0.039	2.638	2.874
WWMU11X512R-DS	0.445	0.224	●									0.217	0.047	2.913	3.150

● : Line up

# STANDARD CUTTING CONDITIONS

ISO	Workpiece material	Hardness	Priority	Chip breakers	Grade	Cutting speed Vc (sfm)	Feed: f (ipr)			Grade	
							DC (in)				Insert
							ø2.165" - ø2.205"	ø2.244" - ø2.874"	ø2.913" - ø3.150"		
P	Low carbon steels (C<0.3) 1018, 1020, 1026, etc.	- 200 HB	First choice	DS	AH6030	525 - 820	0.0016 - 0.0039	0.0016 - 0.0039	0.0016 - 0.0039	B	
			Wear resistance	DJ	AH9030	525 - 1050	0.0016 - 0.0039	0.0016 - 0.0039	0.0016 - 0.0039	B	
	Carbon steels (C>0.3) 1045, 1055, etc.	- 300 HB	First choice	DJ	AH9030	262 - 820	0.0024 - 0.0063	0.0024 - 0.0071	0.0031 - 0.0079	C	
			Fracture resistance	DJ	AH3135	262 - 820	0.0016 - 0.0051	0.0016 - 0.0059	0.0016 - 0.0063	C	
	Low alloy steels 5120, etc.	- 200 HB	First choice	DS	AH6030	525 - 820	0.0016 - 0.0047	0.0016 - 0.0047	0.0016 - 0.0047	D	
			Wear resistance	DJ	AH9030	525 - 820	0.0024 - 0.0055	0.0024 - 0.0055	0.0024 - 0.0055	D	
	Alloy steels 4140, 8620, etc.	- 300 HB	First choice	DJ	AH9030	262 - 656	0.0024 - 0.0063	0.0024 - 0.0071	0.0031 - 0.0079	D	
			Fracture resistance	DJ	AH3135	262 - 656	0.0016 - 0.0051	0.0016 - 0.0055	0.0016 - 0.0059	D	
M	Stainless steels (Austenitic) 304SS, 316SS, etc.	- 200 HB	First choice	DS	AH6030	328 - 656	0.0016 - 0.0047	0.0016 - 0.0047	0.0016 - 0.0047	E	
			-	DJ	AH3135	328 - 656	0.0016 - 0.0047	0.0016 - 0.0047	0.0016 - 0.0047	E	
	Stainless steels (Martensitic and ferritic) 430SS, 416SS, etc.	- 200 HB	First choice	DS	AH6030	328 - 656	0.0016 - 0.0047	0.0016 - 0.0047	0.0016 - 0.0047	F	
			-	DJ	AH3135	328 - 656	0.0016 - 0.0047	0.0016 - 0.0047	0.0016 - 0.0047	F	
	Stainless steels (Precipitation hardening) 17-4 PH, etc.	-	First choice	DS	AH6030	262 - 394	0.0016 - 0.0039	0.0016 - 0.0039	0.0016 - 0.0039	F	
			-	DJ	AH3135	262 - 394	0.0016 - 0.0039	0.0016 - 0.0039	0.0016 - 0.0039	F	
K	Gray cast irons Class 25, Class 30, etc.	150 - 250 HB	First choice	DJ	AH9030	262 - 820	0.0024 - 0.0071	0.0031 - 0.0079	0.0031 - 0.0087	G	
			Fracture resistance	DJ	AH3135	262 - 656	0.0024 - 0.0059	0.0031 - 0.0063	0.0031 - 0.0071	G	
	Ductile cast irons 60-40-18, 60-55-06, etc.	150 - 250 HB	First choice	DJ	AH9030	262 - 656	0.0024 - 0.0063	0.0024 - 0.0071	0.0031 - 0.0079	H	
			Fracture resistance	DJ	AH3135	262 - 492	0.0024 - 0.0059	0.0031 - 0.0063	0.0031 - 0.0071	H	
N	Aluminum alloy	-	First choice	DS	AH6030	656 - 1312	0.0039 - 0.0079	0.0039 - 0.0091	0.0039 - 0.0098	I	
			-	DJ	AH9030	656 - 1312	0.0039 - 0.0079	0.0039 - 0.0091	0.0039 - 0.0098	I	
S	Heat-resistant alloys Inconel718, etc.	- 40 HRC	First choice	DS	AH6030	66 - 197	0.0016 - 0.0031	0.0016 - 0.0039	0.0016 - 0.0039	J	
			-	DJ	AH3135	66 - 197	0.0016 - 0.0031	0.0016 - 0.0039	0.0016 - 0.0039	J	
	Titanium alloys Ti-6Al-4V, etc.	- 40 HRC	First choice	DS	AH6030	131 - 394	0.0024 - 0.0047	0.0024 - 0.0055	0.0024 - 0.0055	K	
			-	DJ	AH3135	131 - 394	0.0024 - 0.0047	0.0024 - 0.0055	0.0024 - 0.0055	K	
H	Hardened steel < 40HRC	- 50 HRC	First choice	DJ	AH9030	164 - 328	0.0016 - 0.0031	0.0016 - 0.0039	0.0016 - 0.0039	L	
			Fracture resistance	DJ	AH3135	131 - 262	0.0016 - 0.0031	0.0016 - 0.0039	0.0016 - 0.0039	L	

## Caution

### Machine

- Use drills on a fully covered machine to maintain safety.
- Use drills on a high powered machine such as a BT50 or CAT50 holders.
- Figure on right shows reference of required machine power.

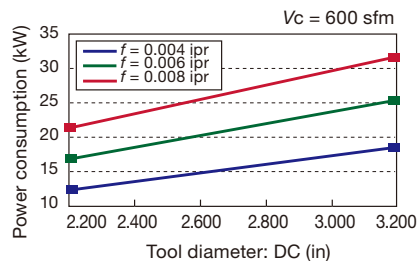

### Cutting coolant

- Internal coolant supply is recommended.
- Coolant pressure higher than 1MPa is essential.
- Use water soluble type coolant.

# TUNGDRILLBIG

## TDBU, TDX cartridge set

Indexable drill, L/D = 2.5, with tool diameter adjustability

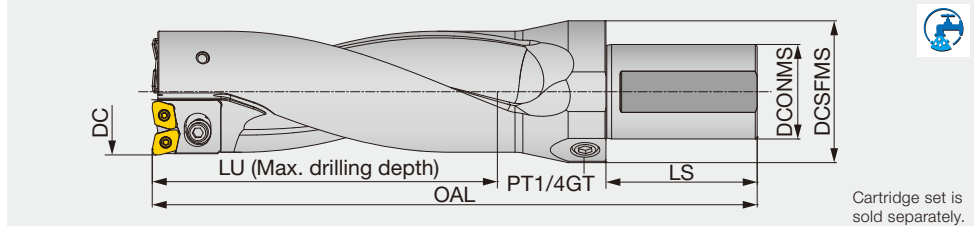

Cartridge set is sold separately.

Body	Cartridge set*	DC	DCONMS	DCSFMS	LU	LS	OAL	WT(lb)	Setting plate Designation	Setting plate Thickness	Insert
Inch	Inch										
TDBU2250-2447-2.5	TDXCA57-62	2.250	2.000	2.953	6.117	4.000	11.874	8.800	-	-	XPMT08T308R-D*
TDBU2250-2447-2.5	TDXCA57-62	2.289	2.000	2.953	6.117	4.000	11.874	8.800	AP0801	0.020	XPMT08T308R-D*
TDBU2250-2447-2.5	TDXCA57-62	2.329	2.000	2.953	6.117	4.000	11.874	8.800	AP0802	0.039	XPMT08T308R-D*
TDBU2250-2447-2.5	TDXCA57-62	2.368	2.000	2.953	6.117	4.000	11.874	8.800	AP0803	0.059	XPMT08T308R-D*
TDBU2250-2447-2.5	TDXCA57-62	2.407	2.000	2.953	6.117	4.000	11.874	8.800	AP0804	0.079	XPMT08T308R-D*
TDBU2250-2447-2.5	TDXCA57-62	2.447**	2.000	2.953	6.117	4.000	11.874	8.800	AP0805	0.098	XPMT08T308R-D*
TDBU2461-2579-2.5	TDXCA63-66	2.461	2.000	2.953	6.447	4.000	12.465	10.100	-	-	XPMT08T308R-D*
TDBU2461-2579-2.5	TDXCA63-66	2.500	2.000	2.953	6.447	4.000	12.465	10.100	AP0801	0.020	XPMT08T308R-D*
TDBU2461-2579-2.5	TDXCA63-66	2.539	2.000	2.953	6.447	4.000	12.465	10.100	AP0802	0.039	XPMT08T308R-D*
TDBU2461-2579-2.5	TDXCA63-66	2.579**	2.000	2.953	6.447	4.000	12.465	10.100	AP0803	0.059	XPMT08T308R-D*
TDBU2632-2868-2.5	TDXCA67-73	2.632	2.000	2.953	7.170	4.000	13.449	11.900	-	-	XPMT110412R-D*
TDBU2632-2868-2.5	TDXCA67-73	2.671	2.000	2.953	7.170	4.000	13.449	11.900	AP1101	0.020	XPMT110412R-D*
TDBU2632-2868-2.5	TDXCA67-73	2.711	2.000	2.953	7.170	4.000	13.449	11.900	AP1102	0.039	XPMT110412R-D*
TDBU2632-2868-2.5	TDXCA67-73	2.750	2.000	2.953	7.170	4.000	13.449	11.900	AP1103	0.059	XPMT110412R-D*
TDBU2632-2868-2.5	TDXCA67-73	2.789	2.000	2.953	7.170	4.000	13.449	11.900	AP1104	0.079	XPMT110412R-D*
TDBU2632-2868-2.5	TDXCA67-73	2.829	2.000	2.953	7.170	4.000	13.449	11.900	AP1105	0.098	XPMT110412R-D*
TDBU2632-2868-2.5	TDXCA67-73	2.868**	2.000	2.953	7.170	4.000	13.449	11.900	AP1106	0.118	XPMT110412R-D*
TDBU2921-3157-2.5	TDXCA74-80	2.921	2.000	2.953	7.894	4.000	13.843	13.700	-	-	XPMT110412R-D*
TDBU2921-3157-2.5	TDXCA74-80	2.961	2.000	2.953	7.894	4.000	13.843	13.700	AP1101	0.020	XPMT110412R-D*
TDBU2921-3157-2.5	TDXCA74-80	3.000	2.000	2.953	7.894	4.000	13.843	13.700	AP1102	0.039	XPMT110412R-D*
TDBU2921-3157-2.5	TDXCA74-80	3.039	2.000	2.953	7.894	4.000	13.843	13.700	AP1103	0.059	XPMT110412R-D*
TDBU2921-3157-2.5	TDXCA74-80	3.079	2.000	2.953	7.894	4.000	13.843	13.700	AP1104	0.079	XPMT110412R-D*
TDBU2921-3157-2.5	TDXCA74-80	3.118	2.000	2.953	7.894	4.000	13.843	13.700	AP1105	0.098	XPMT110412R-D*
TDBU2921-3157-2.5	TDXCA74-80	3.157**	2.000	2.953	7.894	4.000	13.843	13.700	AP1106	0.118	XPMT110412R-D*

\*Cartridge set is sold separately

\*\* max drill diameter that can be achieved with this drill body

### Body

#### SPARE PARTS

Designation	① Setting plate screw	Plug Screw	② Cartridge screw	③ Setting plate 1	③ Setting plate 2	③ Setting plate 3	③ Setting plate 4	③ Setting plate 5	③ Setting plate 6	Wrench for setting plate	Wrench for cartridge	Wrench for plug	④ Washer
TDBU2250-2447-2.5	CSTB-3	PT1/4GN	CM5X0.8X12	AP0801	AP0802	AP0803	AP0804	AP0805	-	T-9D	P-4	P-6	5.3X10X1
TDBU2461-2579-2.5	CSTB-3	PT1/4GN	CHHM6-15	AP0801	AP0802	AP0803	-	-	-	T-9D	P-5	P-6	6.4X12.5X1.6
TDBU2632-2868-2.5	CSTB-3	PT1/4GN	CM6X16	AP1101	AP1102	AP1103	AP1104	AP1105	AP1106	T-9D	P-5	P-6	6.4X12.5X1.6
TDBU2921-3157-2.5	CSTB-3	PT1/4GN	CM6X16	AP1101	AP1102	AP1103	AP1104	AP1105	AP1106	T-9D	P-5	P-6	6.4X12.5X1.6

### Cartridge set

#### SPARE PARTS

Designation	⑤ Insert screw	Wrench
TDXCA57-62	CSTB-3	T-9F
TDXCA63-66	CSTB-3	T-9F
TDXCA67-73	CSTB-4	T-15F
TDXCA74-80	CSTB-4	T-15F

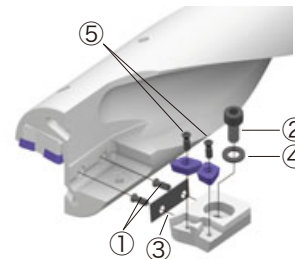

### Cartridge

#### SPARE PARTS

Designation	Insert screw (x2)	Setting plate screw
TDX08CA-C1	CSTB-3	-
TDX08CA-C2	CSTB-3	-
TDX11CA-C1	CSTB-4	-
TDX11CA-C2	CSTB-4	-

#### SPARE PARTS

Designation	Insert screw (x2)	Setting plate screw (x2)
TDX08CA-P1	CSTB-3	CSTB-3
TDX08CA-P2	CSTB-3	CSTB-3
TDX11CA-P1	CSTB-4	CSTB-3
TDX11CA-P2	CSTB-4	CSTB-3

Recommended clamping torque: CSTB-3 = 1.70 lb-ft, CSTB-4 = 2.58 lb-ft

Reference pages: Inserts → J100 - J101, Standard cutting conditions → J101 - J102

# TDB, TDX cartridge set

Indexable drill, L/D = 2.5, with tool diameter adjustability

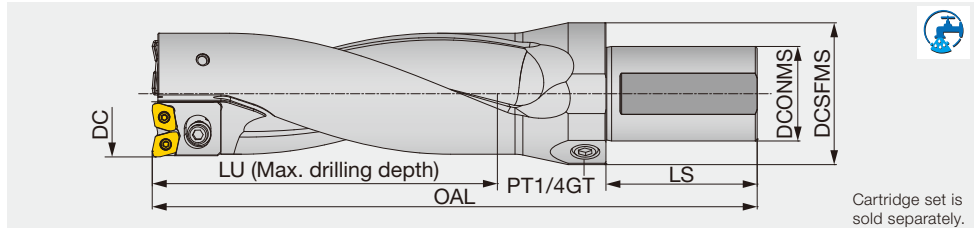

Body	Cartridge set*	DC	DCONMS	DCSFMS	LU	LS	OAL	WT(kg)	Setting plate Designation	Setting plate Thickness (mm)	Insert
TDB55-56F50-2.5	TDXCA55-56	55	50	75	140	80	260	3.2	-	-	XPMT08T308R-D*
TDB55-56F50-2.5	TDXCA55-56	56	50	75	140	80	260	3.2	AP0801	0.5	XPMT08T308R-D*
TDB57-62F50-2.5	TDXCA57-62	57	50	75	155	80	280	3.6	-	-	XPMT08T308R-D*
TDB57-62F50-2.5	TDXCA57-62	58	50	75	155	80	280	3.6	AP0801	0.5	XPMT08T308R-D*
TDB57-62F50-2.5	TDXCA57-62	59	50	75	155	80	280	3.6	AP0802	1	XPMT08T308R-D*
TDB57-62F50-2.5	TDXCA57-62	60	50	75	155	80	280	3.6	AP0803	1.5	XPMT08T308R-D*
TDB57-62F50-2.5	TDXCA57-62	61	50	75	155	80	280	3.6	AP0804	2	XPMT08T308R-D*
TDB57-62F50-2.5	TDXCA57-62	62**	50	75	155	80	280	3.6	AP0805	2.5	XPMT08T308R-D*
TDB63-66F50-2.5	TDXCA63-66	63	50	75	165	80	295	4.2	-	-	XPMT08T308R-D*
TDB63-66F50-2.5	TDXCA63-66	64	50	75	165	80	295	4.2	AP0801	0.5	XPMT08T308R-D*
TDB63-66F50-2.5	TDXCA63-66	65	50	75	165	80	295	4.2	AP0802	1	XPMT08T308R-D*
TDB63-66F50-2.5	TDXCA63-66	66**	50	75	165	80	295	4.2	AP0803	1.5	XPMT08T308R-D*
TDB67-73F50-2.5	TDXCA67-73	67	50	75	183	80	320	5	-	-	XPMT110412R-D*
TDB67-73F50-2.5	TDXCA67-73	68	50	75	183	80	320	5	AP1101	0.5	XPMT110412R-D*
TDB67-73F50-2.5	TDXCA67-73	69	50	75	183	80	320	5	AP1102	1	XPMT110412R-D*
TDB67-73F50-2.5	TDXCA67-73	70	50	75	183	80	320	5	AP1103	1.5	XPMT110412R-D*
TDB67-73F50-2.5	TDXCA67-73	71	50	75	183	80	320	5	AP1104	2	XPMT110412R-D*
TDB67-73F50-2.5	TDXCA67-73	72	50	75	183	80	320	5	AP1105	2.5	XPMT110412R-D*
TDB67-73F50-2.5	TDXCA67-73	73**	50	75	183	80	320	5	AP1106	3	XPMT110412R-D*
TDB74-80F50-2.5	TDXCA74-80	74	50	75	200	80	330	5.7	-	-	XPMT110412R-D*
TDB74-80F50-2.5	TDXCA74-80	75	50	75	200	80	330	5.7	AP1101	0.5	XPMT110412R-D*
TDB74-80F50-2.5	TDXCA74-80	76	50	75	200	80	330	5.7	AP1102	1	XPMT110412R-D*
TDB74-80F50-2.5	TDXCA74-80	77	50	75	200	80	330	5.7	AP1103	1.5	XPMT110412R-D*
TDB74-80F50-2.5	TDXCA74-80	78	50	75	200	80	330	5.7	AP1104	2	XPMT110412R-D*
TDB74-80F50-2.5	TDXCA74-80	79	50	75	200	80	330	5.7	AP1105	2.5	XPMT110412R-D*
TDB74-80F50-2.5	TDXCA74-80	80**	50	75	200	80	330	5.7	AP1106	3	XPMT110412R-D*

\*Cartridge set is sold separately

\*\* max drill diameter that can be achieved with this drill body

## Body SPARE PARTS

Designation	① Setting plate screw	Plug Screw	② Cartridge screw	③ Setting plate 1	③ Setting plate 2	③ Setting plate 3	③ Setting plate 4	③ Setting plate 5	③ Setting plate 6	Wrench for setting plate	Wrench for cartridge	Wrench for plug	④ Washer
TDB55-56F50-2.5	CSTB-3	PT1/4GN	CM5X0.8X12	AP0801	-	-	-	-	-	T-9D	P-4	P-6	5.3X10X1
TDB57-62F50-2.5	CSTB-3	PT1/4GN	CM5X0.8X12	AP0801	AP0802	AP0803	AP0804	AP0805	-	T-9D	P-4	P-6	5.3X10X1
TDB63-66F50-2.5	CSTB-3	PT1/4GN	CHHM6-15	AP0801	AP0802	AP0803	-	-	-	T-9D	P-5	P-6	6.4X12.5X1.6
TDB67-73F50-2.5	CSTB-3	PT1/4GN	CM6X16	AP1101	AP1102	AP1103	AP1104	AP1105	AP1106	T-9D	P-5	P-6	6.4X12.5X1.6
TDB74-80F50-2.5	CSTB-3	PT1/4GN	CM6X16	AP1101	AP1102	AP1103	AP1104	AP1105	AP1106	T-9D	P-5	P-6	6.4X12.5X1.6

## Cartridge set SPARE PARTS

Designation	⑤ Insert screw	Wrench
TDXCA55 - 56	CSTB-3	T-9F
TDXCA57 - 62	CSTB-3	T-9F
TDXCA63 - 66	CSTB-3	T-9F
TDXCA67 - 73	CSTB-4	T-15F
TDXCA74 - 80	CSTB-4	T-15F

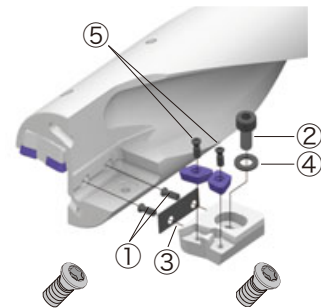

## Cartridge SPARE PARTS

Designation	Insert screw (x2)	Setting plate screw
TDX08CA-C0	CSTB-3	-
TDX08CA-C1	CSTB-3	-
TDX08CA-C2	CSTB-3	-
TDX11CA-C1	CSTB-4	-
TDX11CA-C2	CSTB-4	-

## SPARE PARTS

Designation	Insert screw (x2)	Setting plate screw (x2)
TDX08CA-P0	CSTB-3	CSTB-3
TDX08CA-P1	CSTB-3	CSTB-3
TDX08CA-P2	CSTB-3	CSTB-3
TDX11CA-P1	CSTB-4	CSTB-3
TDX11CA-P2	CSTB-4	CSTB-3

Recommended clamping torque: CSTB-3 = 2.3 N·m, CSTB-4 = 3.5 N·m

Reference pages: Inserts → J100 - J101, Standard cutting conditions → J101 - J102





## INSERT

### DJ

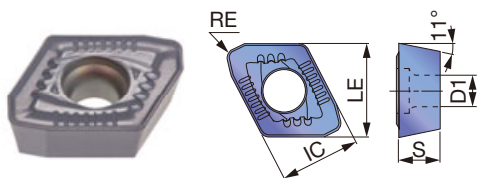

P	Steel			★	☆				
M	Stainless	☆		★					
K	Cast iron		☆	☆	★				
N	Non-ferrous	☆		★					
S	Superalloys	☆		★	☆				
H	Hard materials	☆		★	☆				

★ : First choice  
☆ : Second choice

Designation	IC (in)	LE (in)	Coated				S (in)	D1 (in)	RE (in)	DCN (in)	DCX (in)
			AH725	T1115	AH6030	AH9030					
XPMT08T308R-DJ	0.335	0.390	●	●	●	●	0.156	0.134	0.031	2.165	2.598
XPMT110412R-DJ	0.441	0.492	●	●	●	●	0.187	0.173	0.047	2.638	3.150

● : Line up

### DS

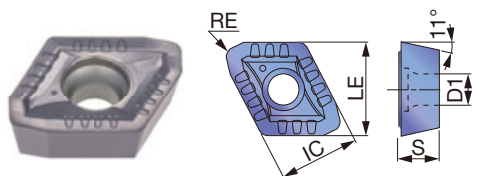

P	Steel	☆	★						
M	Stainless	☆	★						
K	Cast iron								
N	Non-ferrous	☆							
S	Superalloys	☆	★						
H	Hard materials								

★ : First choice  
☆ : Second choice

Designation	IC (in)	LE (in)	Coated		S (in)	D1 (in)	RE (in)	DCN (in)	DCX (in)
			AH725	AH6030					
XPMT08T308R-DS	0.335	0.390	●	●	0.156	0.134	0.031	2.165	2.598
XPMT110412R-DS	0.441	0.492	●	●	0.187	0.173	0.047	2.638	3.150

● : Line up

### DW

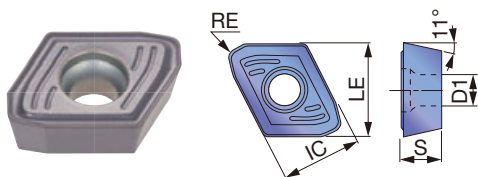

P	Steel	☆	★	☆					
M	Stainless	☆	★	☆					
K	Cast iron		☆	★					
N	Non-ferrous	☆	★						
S	Superalloys	☆	★	☆					
H	Hard materials	☆	★	☆					

★ : First choice  
☆ : Second choice

Designation	IC (in)	LE (in)	Coated			S (in)	D1 (in)	RE (in)	DCN (in)	DCX (in)
			AH725	AH6030	AH9030					
XPMT08T308R-DW	0.335	0.390	●	●	●	0.156	0.134	0.031	2.165	2.598
XPMT110412R-DW	0.441	0.492	●	●	●	0.187	0.173	0.047	2.638	3.150

● : Line up



DG

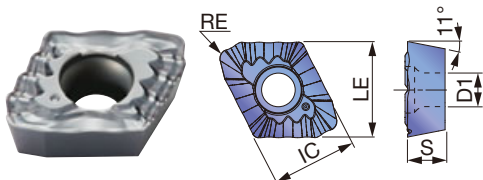

<b>P</b>	Steel	★							
<b>M</b>	Stainless	☆							
<b>K</b>	Cast iron								
<b>N</b>	Non-ferrous	★							
<b>S</b>	Superalloys	☆							
<b>H</b>	Hard materials								

★ : First choice  
☆ : Second choice

Designation	IC (in)	LE (in)	Coated						S (in)	D1 (in)	RE (in)	DCN (in)	DCX (in)
			AH725										
XPMT08T308R-DG	0.335	0.390	●						0.156	0.134	0.031	2.165	2.598
XPMT110412R-DG	0.441	0.492	●						0.187	0.173	0.047	2.638	3.150

● : Line up

RECOMMENDED INSERT

ISO	Workpiece material	Hardness	First choice	High feed	High speed	Chipping resistance	Wear resistance	Surface finish	Chip control
<b>P</b>	Low carbon steels (C ≤ 0.3%)	- 200 HB	DS, AH6030	-	-	DS, AH725	-	DW, AH6030	DG, AH725
	Carbon steels (C > 0.3%) Alloy steels	- 300 HB	DJ, AH6030	DW, AH6030	DJ, AH9030	DW, AH725	DJ, AH9030	DW, AH6030	-
	Low alloy steels	- 200 HB	DS, AH6030	-	-	DS, AH725	-	DW, AH6030	-
<b>M</b>	Stainless steel	- 200 HB	DS, AH6030	-	-	DS, AH725	-	DW, AH6030	DG, AH725
<b>K</b>	Gray cast irons	150 - 250 HB	DJ, AH9030	DW, AH9030	DJ, T1115	DW, AH725	-	DW, AH9030	-
	Ductile cast irons	150 - 250 HB	DJ, AH9030	DW, AH9030	-	DW, AH725	-	DW, AH9030	-
<b>N</b>	Aluminum alloy	-	DJ, AH725	DW, AH725	DS, AH6030	-	-	DW, AH725	DG, AH725
<b>S</b>	Titanium alloys Heat-resistant alloys	- 40 HRC	DS, AH6030	-	-	DW, AH725	-	DW, AH725	DG, AH725
<b>H</b>	Hardened steel	- 50 HRC	DJ, AH9030	DW, AH9030	-	DW, AH725	-	DW, AH9030	-

Grade  
Insert  
Ext. Toolholder  
Int. Toolholder  
Threading  
Grooving  
Miniature tool  
Milling cutter  
Endmill  
Drilling tool  
Tooling System  
User's Guide  
Index





## STANDARD CUTTING CONDITIONS

ISO	Workpiece material	Hardness	Cutting speed		Feed: $f$ (ipr)		
			$V_c$ (sfm)	$\phi 2.165'' \sim \phi 2.441''$	$\phi 2.480'' \sim \phi 2.874''$	$\phi 2.913'' \sim \phi 3.150''$	
<b>P</b>	Low carbon steels (C < 0.3) 1018, 1026, etc.	- 200 HB	525 - 1050	0.0016 - 0.0039	0.0016 - 0.0039	0.0016 - 0.0039	
	Carbon steels (C > 0.3) 1045, 1055, etc.	- 300 HB	262 - 820	0.0031 - 0.0071	0.0031 - 0.0071	0.0039 - 0.0079	
	Low alloy steels 4130, etc.	- 200 HB	525 - 820	0.0016 - 0.0063	0.0016 - 0.0063	0.0016 - 0.0063	
	Alloy steels 4140, 5120, etc.	- 300 HB	262 - 656	0.0031 - 0.0071	0.0031 - 0.0071	0.0031 - 0.0079	
<b>M</b>	Stainless steels (Austenitic) 304, 316, etc.	- 200 HB	328 - 656	0.0016 - 0.0047	0.0016 - 0.0047	0.0024 - 0.0055	
	Stainless steels (Martensitic and ferritic) 430, 416, etc.	- 200 HB	328 - 656	0.0016 - 0.0047	0.0016 - 0.0047	0.0024 - 0.0055	
	Stainless steels (Precipitation hardening) 630, etc.	-	262 - 394	0.0016 - 0.0039	0.0016 - 0.0039	0.0024 - 0.0047	
<b>K</b>	Gray cast irons Class 25, Class 30, etc.	150 - 250 HB	262 - 820	0.0031 - 0.0079	0.0031 - 0.0079	0.0039 - 0.0087	
	Ductile cast irons 60-40-18, etc.	150 - 250 HB	262 - 656	0.0031 - 0.0079	0.0031 - 0.0079	0.0039 - 0.0087	
<b>N</b>	Aluminum alloy 333.0, 383.0, etc.	-	656 - 1312	0.0059 - 0.0098	0.0059 - 0.0098	0.0071 - 0.011	
<b>S</b>	Heat-resistant alloys Inconel 718, etc.	- 40 HRC	66 - 197	0.0016 - 0.0039	0.0016 - 0.0039	0.0016 - 0.0039	
	Titanium alloys Ti-6Al-4V, etc.	- 40 HRC	131 - 394	0.0024 - 0.0047	0.0024 - 0.0047	0.0024 - 0.0047	
<b>H</b>	Hardened steel $\geq 40\text{HRC}$	- 50 HRC	131 - 328	0.0016 - 0.0039	0.0016 - 0.0039	0.0016 - 0.0039	

## Standard cutting conditions for DG type chipbreaker

ISO	Workpiece material	Hardness	Cutting speed $V_c$ (sfm)	Series L/D	Feed: $f$ (ipr)	
					$\phi 1.063'' \sim \phi 1.260''$	$\phi 1.299'' \sim \phi 2.126''$
<b>P</b>	Low carbon steels (C < 0.3) 1018, 1026, etc.	- 200 HB	260 - 590	2D, 3D 4D, 5D	0.0016 - 0.0039	

### Caution

#### Machine

- Use drills on a fully covered machine to maintain safety.
- Use drills on a high powered machine such as a BT50 or CAT50 holders.
- Figure on right shows reference of required machine power.

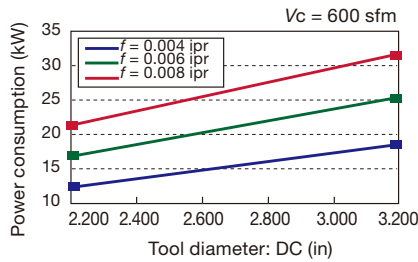

#### Cutting coolant

- Use water soluble type coolant with internal supply.
- Coolant pressure higher than 1MPa is essential.

# Drilling Insert (Former products)

## ● LPMT03X206R-D4, LPMT05X204-D4

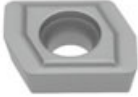
Shape	Designation	Coated			Applicable drill diameter	Applicable drill
		T313W				
	LPMT03X206R-D4	●			φ14 ~ φ17.5 (φ0.551" - φ0.689")	TDJ (Former products)
	LPMT05X204-D4	●			φ14 ~ φ17.5 (φ0.551" - φ0.689")	

## ● SPMP831DS, SPMP/M\*\*2ERD

Shape	Designation	ISO Metric Designation	Coated			Applicable drill diameter	Applicable drill
			T313W				
	SPMP831DS	SPMT060204-DS	●			φ18 ~ φ19.5 (φ0.709" - φ0.768")	TDR, for Peripheral side (Former products)
	SPMP042ERD	SPMP080308ER-D	●			φ20 ~ φ28.5 (φ0.787" - φ1.122")	
	SPMM322ERD	SPMT090308ER-D	●			φ29 ~ φ34.5 (φ1.142" - φ1.358")	
	SPMM432ERD	SPMT120408ER-D	●			φ35 ~ φ49 (φ1.378" - φ1.929")	

## ● TPMP\*\*ZDS, TPMP\*\*ZERD, TPMM\*\*ZERD

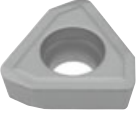
Shape	Designation	Coated			Applicable drill diameter	Applicable drill
		T313W				
	TPMP83ZDS	●			φ18 ~ φ19.5 (φ0.709" - φ0.768")	TDR, for Central side (Former products)
	TPMP04ZERD	●			φ20 ~ φ28.5 (φ0.787" - φ1.122")	
	TPMM32ZERD	●			φ29 ~ φ34.5 (φ1.142" - φ1.358")	
	TPMM43ZERD	●			φ35 ~ φ54 (φ1.378" - φ2.126")	

TPMM43ZERD can be used on the peripheral side.

## ● WCMT\*\*-D...

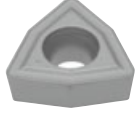



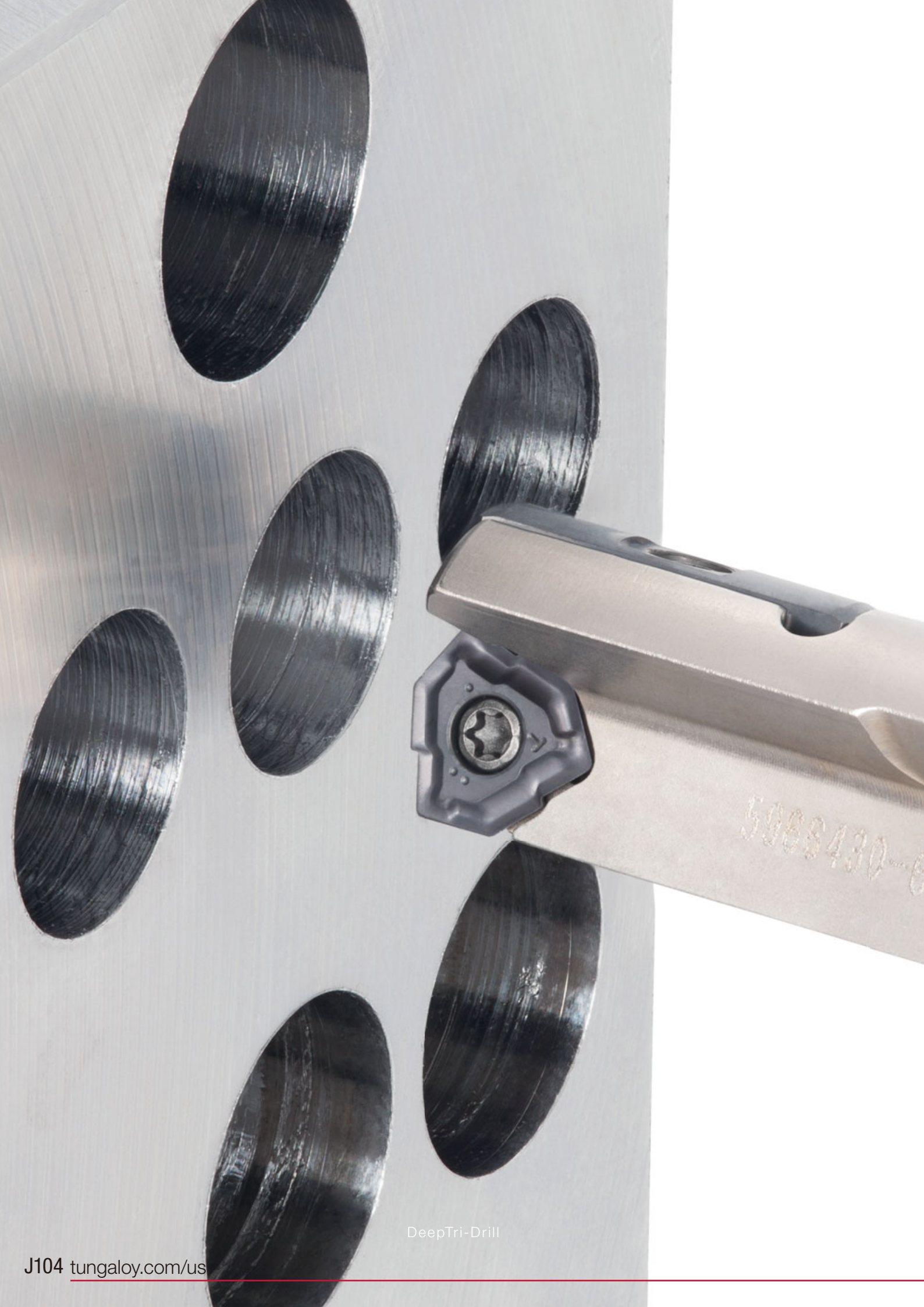

Shape	Designation	Coated			Applicable drill
		AH120	AH140	T313W	
	WCMT050308-DC			●	for counter boring, and drilling.
	WCMT050308-D4	●	●	●	
	WCMT06T308-DC			●	
	WCMT06T308-D4	●	●	●	
	WCMT080412-DC			●	
	WCMT080412-D4			●	

● : Line up







DeepTri-Drill

# Deep Hole Drill

		Inch	Metric
	<p><b>DEEPTDRILL</b></p> <p>Excellent productivity and stability in deep hole drilling</p> <p> <math>\varnothing 0.437'' - \varnothing 1.575''</math> , <math>\varnothing 10 \text{ mm} - \varnothing 40 \text{ mm}</math> / L/D = 8 - 45 for machining centers OAL <math>\leq 64.961''</math> , 1650 mm for gundrill machines (standard line-ups)</p> <p>J007 J106 -</p>	<input checked="" type="checkbox"/>	<input checked="" type="checkbox"/>
	<p><b>GUNDRILL</b></p> <p>Brazed gundrills suitable for small diameter deep hole drilling</p> <p> <math>\varnothing 3 \text{ mm} - \varnothing 12.2 \text{ mm}</math> / OAL <math>\leq 1650 \text{ mm}</math> (standard line-ups)</p> <p>J007, J106 J131</p>	<input type="checkbox"/>	<input checked="" type="checkbox"/>
	<p><b>TRI-FINE</b></p> <p>Direct mount drill head with 3-cornered inserts</p> <p> <math>\varnothing 16 \text{ mm} - \varnothing 28 \text{ mm}</math> , <math>\varnothing 0.630'' - \varnothing 1.102''</math></p> <p>J007 J132 -</p>	<input type="checkbox"/>	<input checked="" type="checkbox"/>
	<p><b>FINE-BEAM</b></p> <p>Direct mount deep hole drilling heads</p> <p> <math>\varnothing 25 \text{ mm} - \varnothing 89 \text{ mm}</math> , <math>\varnothing 0.984'' - \varnothing 3.504''</math></p> <p>J007 J132 -, J139 -</p>	<input type="checkbox"/>	<input checked="" type="checkbox"/>
	<p><b>UNIDEX</b></p> <p>Indexable deep hole drilling heads with adjustable diameters</p> <p> <math>\varnothing 38 \text{ mm} - \varnothing 293.99 \text{ mm}</math> , <math>\varnothing 1.496'' - \varnothing 11.574''</math></p> <p>J007 J132 -, J147 -</p>	<input type="checkbox"/>	<input checked="" type="checkbox"/>
	<p><b>Brazed BTA tools</b></p> <p>New solution for BTA drilling with two types of tools: single tube and double tube</p> <p> <math>\varnothing 8 - \varnothing 65 \text{ mm}</math> , <math>\varnothing 0.315'' - \varnothing 2.559''</math></p> <p>J007 J132 -, J168 -</p>	<input type="checkbox"/>	<input checked="" type="checkbox"/>
	<p><b>HF drills for deep hole drilling</b></p> <p>Indexable deep hole drills for large diameter with high productivity</p> <p> <math>\varnothing 30 \text{ mm} - \varnothing 63 \text{ mm}</math> , <math>\varnothing 0.453'' - \varnothing 1.260''</math> , hole depth: L/D = 14</p> <p>J007, J181</p>	<input type="checkbox"/>	<input checked="" type="checkbox"/>

# Indexable Gundrill guide

★ : First choice  
☆ : Second choice

Drill series	Designation	Shape	Drill diameter (mm)	Effective Cutting edge	L/D	Coolant supply	IT class	Straightness (mm)	Machine				Workpiece material						Note	Page
									Lathes	Vertical machining centers	Horizontal machining centers	Gundrill machines	P	M	K	N	S	H		
<b>DEEPTDRILL</b>	<b>MCTR</b>		0.437" - 1.575", ø10 - ø40 mm	1	8 - 45	Int.	IT10-11	0.1/100	○	○	○		★	☆	★	☆	☆	☆	Indexable	<b>J108 -</b>
	<b>MCTRCH</b>		0.578" - 0.937", ø14 - ø28 mm	1	25	Int.	IT10-11	0.1/100	○	○	○		★	☆	★	☆	☆	☆	Indexable	<b>J117</b>
	<b>TRLG</b>		0.500" - 0.531", ø12 - ø30 mm	1	801.8 - 1652.9 mm	Int.	IT10-11	0.1/100	△	△	△	○	★	☆	★	☆	☆	☆	Indexable	<b>J119-</b>
	<b>TRLGCH</b>		0.578" - 0.957", ø14.68 - ø24 mm	1	1652 - 1833.4 mm	Int.	IT10-11	0.1/100	△	△	△	○	★	☆	★	☆	☆	☆	Indexable	<b>J121</b>
Brazed Gundrill	<b>SLJ</b>		ø3 - ø12.2 mm	1	400 - 1650 mm	Int.	IT7-8	0.1/100	△	△	△	○	☆	☆	★	★	☆	☆	Brazed	<b>J131</b>



# DEEPT<sup>RI</sup>DRILL

Smallest diameter  
indexable gun drill  
- DeepTri-Drill expansion  
down to  $\varnothing 0.394"$ ,  $\varnothing 10$  mm



## Wide range of solutions for various deep hole applications

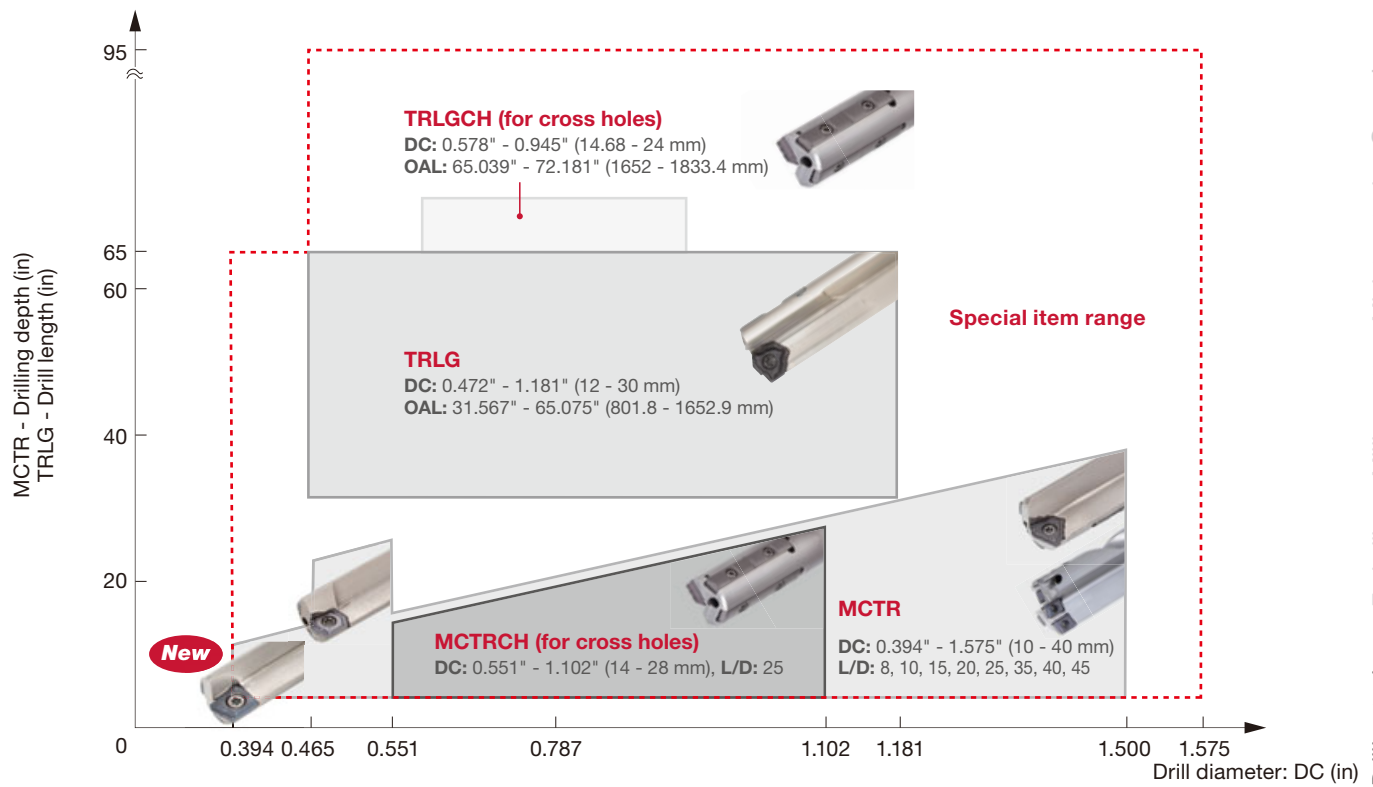

Model	DC Range (in)	DC Range (mm)	Cutting Edges
<b>ZSGT</b>	0.394" - 0.4646"	10 - 11.8 mm	1 cutting edge
<b>LOGT</b>	0.4650" - 0.5508"	11.81 - 13.99 mm	2 cutting edges
<b>TOHT</b>	0.5512" - 1.1024"	14 - 28 mm	3 cutting edges
<b>FBM...-I/C / FBH...</b>	1.1028" - 1.575"	28.01 - 40 mm	2 cutting edges



# DEEPT<sup>RI</sup> DRILL

## MCTR-F L/D=8

Indexable gun drill, L/D = 8, for lathes and machining centers

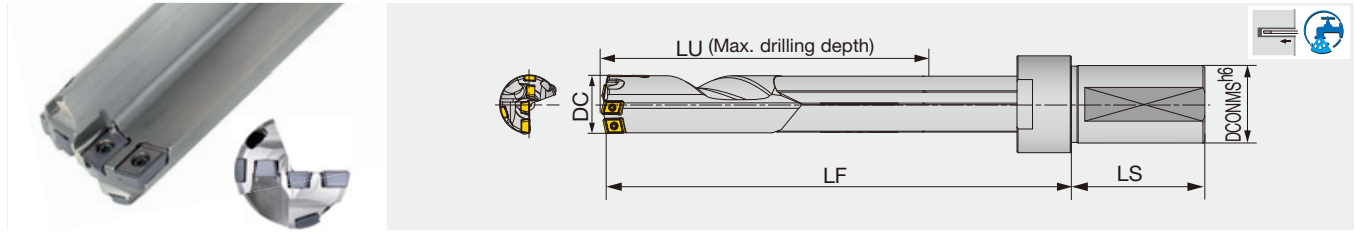

Metric	DC	DCONMS	LU	LS	LF	Insert	Guide pad
MCTR33.10XFM40-8	33.1	40	275	69	350	FBM07**-C, FBM07**-I, FBH08**-P	GP07, GP07-20-120-DC
MCTR39.10XFM40-8	39.1	40	323	69	407	FBM08**-C, FBM07**-I, FBH09**-P	GP08, GP08-25-155-DC

DC (mm)	Tool diameter tolerance (mm)	Applicable tolerance range of hole diameter (mm)
33.1, 39.1	0 / - 0.07	+ 0.05 / - 0.1

Max. DC = 40: Available tailor-made tools

### Caution:

The drill pipe is blackened to increase the resistance to corrosion, and the finished surface may appear uneven. This, however, will not affect the performance of the drill.

### SPARE PARTS



Designation	Insert						Guide pad	
	Central		Intermediate		Peripheral		Screw	Wrench
	Screw	Wrench	Screw	Wrench	Screw	Wrench	Screw	Wrench
MCTR33.1..., MCTR39.1...	CSTB-2.5	T-8F	CSTB-2.5	T-8F	CSTB-2.5	T-8F	CSTB-3S	T-9F

Recommended clamping torque: CSTB2.5 = 1.3 N·m, CSTB-3S = 2.3 N·m

Reference pages: Inserts, Guide pads → **J126 - J128**, Standard cutting conditions → **J130**

# MCTR L/D=10

Indexable gun drill, L/D = 10, for lathes and machining centers

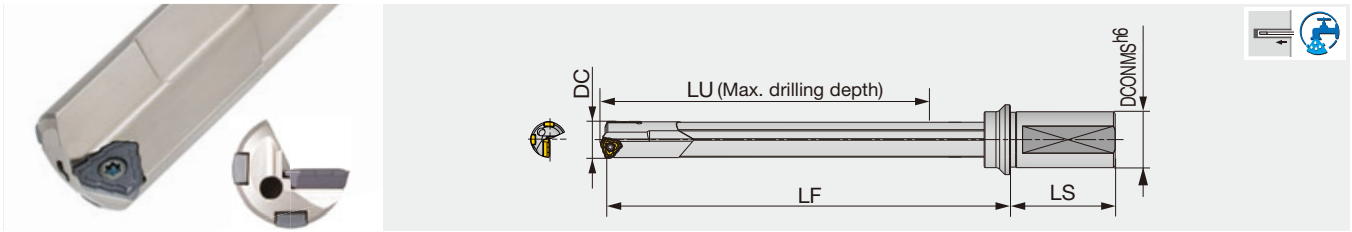

Inch	DC	DCONMS	LU	LS	LF	Insert	Guide pad
MCTR15.88XU25.4-10	0.625	1.000	6.378	2.205	7.756	TOHT07...	GP05-060, GP05-18-060-DC
MCTR17.45XU25.4A-10	0.687	1.000	7.173	2.205	8.661	TOHT08..	GP05-075, GP05-18-075-DC
MCTR18.24XU25.4-10	0.718	1.000	7.598	2.205	9.134	TOHT09..	GP06-085, GP06-20-085-DC
MCTR18.64XU25.4-10	0.734	1.000	7.598	2.205	9.134	TOHT09..	GP06-085, GP06-20-085-DC
MCTR19.05XU25.4-10	0.750	1.000	7.992	2.205	9.567	TOHT09..	GP06-085, GP06-20-085-DC
MCTR19.94XU31.75-10	0.785	1.250	7.992	2.362	10.039	TOHT09..	GP06-085, GP06-20-085-DC
MCTR20.62XU31.75-10	0.812	1.250	8.394	2.362	10.039	TOHT10..	GP06-085, GP06-20-085-DC
MCTR22.23XU31.75-10	0.875	1.250	9.189	2.362	10.945	TOHT11..	GP06-100, GP06-20-100-DC
MCTR23.80XU31.75-10	0.937	1.250	9.976	2.362	11.850	TOHT11..	GP06-100, GP06-20-100-DC
MCTR25.40XU31.75-10	1.000	1.250	10.378	2.362	12.283	TOHT12..	GP06, GP06-20-120-DC
MCTR26.97XU31.75X-10	1.062	1.250	11.165	2.362	13.189	TOHT12..	GP06, GP06-20-120-DC

Metric	DC	DCONMS	LU	LS	LF	Insert	Guide pad
MCTR16.00XM25A-10	16	25	172.2	56	209	TOHT08...	GP05-075, GP05-18-075-DC
MCTR16.50XM25A-10	16.5	25	172.2	56	209	TOHT08...	GP05-075, GP05-18-075-DC
MCTR17.00XM25A-10	17	25	182.2	56	220	TOHT08...	GP05-075, GP05-18-075-DC
MCTR17.45XU25.4A-10	17.45	25.4	182.2	56	220	TOHT08...	GP05-075, GP05-18-075-DC
MCTR18.00XM25A-10	18	25	192.2	56	232	TOHT08...	GP05-075, GP05-18-075-DC
MCTR18.24XU25.4-10	18.24	25.4	193	56	232	TOHT09..	GP06-085, GP06-20-085-DC
MCTR18.64XU25.4-10	18.64	25.4	193	56	232	TOHT09..	GP06-085, GP06-20-085-DC
MCTR19.00XM25-10	19	25	203	56	243	TOHT09...	GP06-085, GP06-20-085-DC
MCTR19.05XU25.4-10	19.05	25.4	203	56	243	TOHT09..	GP06-085, GP06-20-085-DC
MCTR19.94XU31.75-10	19.94	31.75	213	60	255	TOHT09..	GP06-085, GP06-20-085-DC
MCTR20.00XM32-10	20	32	213	60	255	TOHT09...	GP06-085, GP06-20-085-DC
MCTR20.62XU31.75-10	20.62	31.75	213.2	60	255	TOHT10..	GP06-085, GP06-20-085-DC
MCTR21.00XM32-10	21	32	223.2	60	266	TOHT10...	GP06-085, GP06-20-085-DC
MCTR22.00XM32-10	22	32	233.4	60	278	TOHT11...	GP06-100, GP06-20-100-DC
MCTR22.23XU31.75-10	22.23	31.75	233.4	60	278	TOHT11..	GP06-100, GP06-20-100-DC
MCTR23.00XM32-10	23	32	243.4	60	289	TOHT11...	GP06-100, GP06-20-100-DC
MCTR23.80XU31.75-10	23.8	31.75	253.4	60	301	TOHT11..	GP06-100, GP06-20-100-DC
MCTR24.00XM32-10	24	32	253.4	60	301	TOHT11...	GP06-100, GP06-20-100-DC
MCTR25.00XM32-10	25	32	263.4	60	312	TOHT11...	GP06-100, GP06-20-100-DC
MCTR25.40XU31.75-10	25.4	31.75	263.7	60	312	TOHT12..	GP06, GP06-20-120-DC
MCTR26.00XM40-10	26	40	273.7	70	324	TOHT12...	GP06, GP06-20-120-DC
MCTR26.97XU31.75X-10	26.97	31.75	283.7	60	335	TOHT12..	GP06, GP06-20-120-DC
MCTR27.00XM40-10	27	40	283.7	70	335	TOHT12...	GP06, GP06-20-120-DC
MCTR28.00XM40-10	28	40	283.7	70	337	TOHT12...	GP06, GP06-20-120-DC

DC (in)	Tool diameter tolerance (in)	Applicable tolerance range of hole diameter (in)	DC (mm)	Tool diameter tolerance (mm)	Applicable tolerance range of hole diameter (mm)
0.625 - 1.102	0 / - 0.003	+ 0.002 / - 0.004	16 - 28	0 / - 0.07	+ 0.05 / - 0.1

## SPARE PARTS

Designation	Insert		Guide pad	
	Screw	Wrench	Screw	Wrench
MCTR16... - MCTR20.00...	SR14-560/S	T-8F	SR34-508	T-7F
MCTR20.62... - MCTR21...	SR34-506	T-9F	SR34-508	T-7F
MCTR22... - MCTR25.00...	SR14-571/S	T-10/5	SR34-508	T-7F
MCTR25.4... - MCTR28...	SR14-506	T-15F	SR34-508	T-7F

Recommended clamping torque: SR34-506 = 0.66 lb-ft, SR34-508 = 0.9 lb-ft, SR14-560/S = 0.89 lb-ft, SR14-571/S = 3.2 lb-ft, SR14-506 = 3.54 lb-ft

Reference pages: Inserts, Guide pads → **J125 - J128**, Standard cutting conditions → **J130**

Grade  
Insert  
Ext. Toolholder  
Int. Toolholder  
Threading  
Grooving  
Milling cutter  
Endmill  
Drilling tool  
Tooling System  
User's Guide  
Index



Indexable gun drill, L/D = 10, for lathes and machining centers

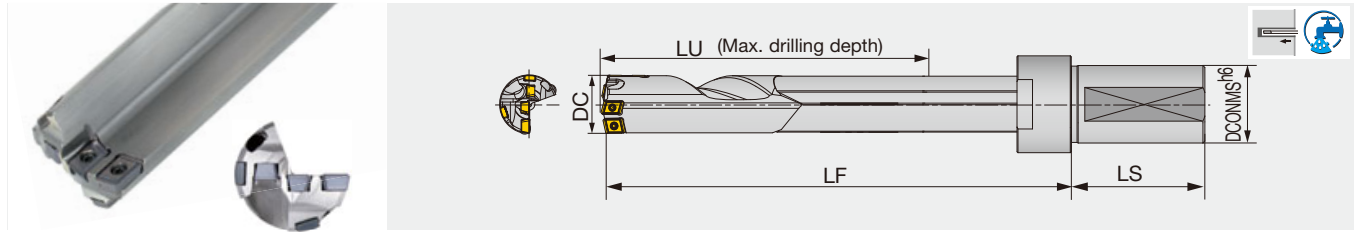

Inch	DC	DCONMS	LU	LS	LF	Insert	Guide pad
MCTR28.58XFU31.75-10	1.125	1.250	11.520	2.717	14.173	FBM07**-C, FBM06**-I, FBH06**-P	GP06, GP06-20-120-DC
MCTR31.75XFU31.75-10	1.250	1.250	12.717	2.717	15.551	FBM07**-C, FBM07**-I, FBH08**-P	GP06, GP06-20-120-DC
MCTR34.93XFU31.75-10	1.375	1.250	13.902	2.717	16.850	FBM07**-C, FBM07**-I, FBH08**-P	GP07, GP07-20-120-DC
MCTR38.10XFU31.75-10	1.500	1.250	15.488	2.717	18.661	FBM08**-C, FBM07**-I, FBH09**-P	GP08, GP08-25-155-DC

Metric	DC	DCONMS	LU	LS	LF	Insert	Guide pad
MCTR28.58XFU31.75-10	28.58	31.75	292.6	69	360	FBM07**-C, FBM06**-I, FBH06**-P	GP06, GP06-20-120-DC
MCTR29.00XFM40-10	29	40	292.6	69	360	FBM07**-C, FBM06**-I, FBH06**-P	GP06, GP06-20-120-DC
MCTR30.00XFM40-10	30	40	312.9	69	383	FBM07**-C, FBM07**-I, FBH08**-P	GP06, GP06-20-120-DC
MCTR31.00XFM40-10	31	40	312.9	69	383	FBM07**-C, FBM07**-I, FBH08**-P	GP06, GP06-20-120-DC
MCTR31.75XFU31.75-10	31.75	31.75	323	69	395	FBM07**-C, FBM07**-I, FBH08**-P	GP06, GP06-20-120-DC
MCTR32.00XFM40-10	32	40	323	69	395	FBM07**-C, FBM07**-I, FBH08**-P	GP06, GP06-20-120-DC
MCTR33.00XFM40-10	33	40	333.1	69	406	FBM07**-C, FBM07**-I, FBH08**-P	GP06, GP06-20-120-DC
MCTR34.00XFM40-10	34	40	343	69	418	FBM07**-C, FBM07**-I, FBH08**-P	GP07, GP07-20-120-DC
MCTR34.93XFU31.75-10	34.93	31.75	353.1	69	428	FBM07**-C, FBM07**-I, FBH08**-P	GP07, GP07-20-120-DC
MCTR35.00XFM40-10	35	40	353.1	69	428	FBM07**-C, FBM07**-I, FBH08**-P	GP07, GP07-20-120-DC
MCTR36.00XFM40-10	36	40	363.1	69	441	FBM08**-C, FBM07**-I, FBH08**-P	GP07, GP07-20-120-DC
MCTR37.00XFM40-10	37	40	373	69	451	FBM08**-C, FBM07**-I, FBH08**-P	GP07, GP07-20-120-DC
MCTR38.00XFM40-10	38	40	383.1	69	464	FBM08**-C, FBM07**-I, FBH08**-P	GP07, GP07-20-120-DC
MCTR38.10XFU31.75-10	38.1	31.75	393.4	69	474	FBM08**-C, FBM07**-I, FBH09**-P	GP08, GP08-25-155-DC
MCTR39.00XFM40-10	39	40	393.4	69	474	FBM08**-C, FBM07**-I, FBH09**-P	GP08, GP08-25-155-DC
MCTR40.00XFM40-10	40	40	403.3	69	487	FBM08**-C, FBM07**-I, FBH09**-P	GP08, GP08-25-155-DC

DC (in)	Tool diameter tolerance (in)	Applicable tolerance range of hole diameter (in)	DC (mm)	Tool diameter tolerance (mm)	Applicable tolerance range of hole diameter (mm)
1.125 - 1.500	0 / - 0.003	+ 0.002 / - 0.004	28.58 - 40	0 / - 0.07	+ 0.05 / - 0.1

Max. DC = 40: Available tailor-made tools

### Caution:

The drill pipe is blackened to increase the resistance to corrosion, and the finished surface may appear uneven. This, however, will not affect the performance of the drill.

### SPARE PARTS



Designation	Insert						Guide pad	
	Central		Intermediate		Peripheral		Screw	Wrench
	Screw	Wrench	Screw	Wrench	Screw	Wrench		
MCTR28.58... - MCTR29...	CSTB-2.5	T-8F	CSTB-2.2	T-7F	CSTB-2.2	T-7F	SR34-508	T-7F
MCTR30... - MCTR33...	CSTB-2.5	T-8F	CSTB-2.5	T-8F	CSTB-2.5	T-8F	SR34-508	T-7F
MCTR34... - MCTR40...	CSTB-2.5	T-8F	CSTB-2.5	T-8F	CSTB-2.5	T-8F	CSTB-3S	T-9F

Recommended clamping torque: SR34-508 = 0.66 lb-ft, CSTB-2.2 = 0.74 lb-ft, CSTB-2.5 = 0.96 lb-ft, CSTB-3S = 1.70 lb-ft

Reference pages: Inserts, Guide pads → **J126 - J128**, Standard cutting conditions → **J130**

# MCTR L/D=15

Indexable gun drill, L/D = 15, for lathes and machining centers

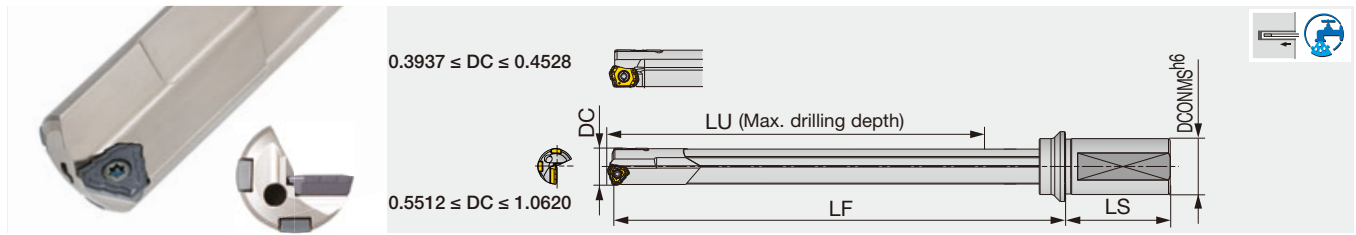

Inch	DC	DCONMS	LU	LS	LF	Insert	Guide pad
MCTR11.11XU19.05-15	0.437	0.750	7.154	1.968	8.228	LOGT06..	GP04-055, GP04-16-055-DC
MCTR12.70XU25.4-15	0.500	1.000	7.748	2.205	9.016	LOGT06..	GP04-055, GP04-16-055-DC
MCTR13.49XU25.4-15	0.531	1.000	8.339	2.205	9.646	LOGT06..	GP04-055, GP04-16-055-DC
MCTR14.27XU25.4-15	0.562	1.000	8.937	2.205	10.276	TOHT07..	GP05-060, GP05-18-060-DC
MCTR15.88XU25.4-15	0.625	1.000	9.528	2.205	10.984	TOHT07..	GP05-060, GP05-18-060-DC
MCTR17.45XU25.4A-15	0.687	1.000	10.717	2.205	12.205	TOHT08..	GP05-075, GP05-18-075-DC
MCTR18.24XU25.4-15	0.718	1.000	11.339	2.205	12.874	TOHT09..	GP06-085, GP06-20-085-DC
MCTR18.64XU25.4-15	0.734	1.000	11.339	2.205	12.874	TOHT09..	GP06-085, GP06-20-085-DC
MCTR19.05XU25.4-15	0.750	1.000	11.929	2.205	13.504	TOHT09..	GP06-085, GP06-20-085-DC
MCTR19.94XU31.75-15	0.785	1.250	12.520	2.362	14.173	TOHT09..	GP06-085, GP06-20-085-DC
MCTR20.62XU31.75-15	0.812	1.250	12.528	2.362	14.173	TOHT10..	GP06-085, GP06-20-085-DC
MCTR22.23XU31.75-15	0.875	1.250	13.717	2.362	15.472	TOHT11..	GP06-100, GP06-20-100-DC
MCTR23.80XU31.75-15	0.937	1.250	14.898	2.362	16.772	TOHT11..	GP06-100, GP06-20-100-DC
MCTR25.40XU31.75-15	1.000	1.250	15.500	2.362	17.402	TOHT12..	GP06, GP06-20-120-DC
MCTR26.97XU31.75X-15	1.062	1.250	16.681	2.362	18.701	TOHT12..	GP06, GP06-20-120-DC

Metric	DC	DCONMS	LU	LS	LF	Insert	Guide pad
MCTR12.00XM20-15	12	20	196.8	50	225	LOGT06...	GP04-055, GP04-16-055-DC
MCTR12.50XM20-15	12.5	20	196.8	50	226	LOGT06...	GP04-055, GP04-16-055-DC
MCTR12.70XU25.4-15	12.7	25.4	196.8	56	229	LOGT06...	GP04-055, GP04-16-055-DC
MCTR13.00XM25-15	13	25	211.8	56	245	LOGT06...	GP04-055, GP04-16-055-DC
MCTR13.49XU25.4-15	13.49	25.4	211.8	56	245	LOGT06..	GP04-055, GP04-16-055-DC
MCTR13.50XM25-15	13.5	25	211.8	56	245	LOGT06...	GP04-055, GP04-16-055-DC
MCTR14.00XM25-15	14	25	227	56	245	TOHT07...	GP05-060, GP05-18-060-DC
MCTR14.27XU25.4-15	14.27	25.4	227	56	261	TOHT07..	GP05-060, GP05-18-060-DC
MCTR14.50XM25-15	14.5	25	227	56	262	TOHT07...	GP05-060, GP05-18-060-DC
MCTR15.00XM25-15	15	25	242	56	278	TOHT07...	GP05-060, GP05-18-060-DC
MCTR15.88XU25.4-15	15.88	25.4	242	56	279	TOHT07..	GP05-060, GP05-18-060-DC
MCTR16.00XM25A-15	16	25	257.2	56	294	TOHT08...	GP05-075, GP05-18-075-DC
MCTR16.50XM25A-15	16.5	25	257.2	56	294	TOHT08...	GP05-075, GP05-18-075-DC
MCTR17.00XM25A-15	17	25	272.2	56	310	TOHT08...	GP05-075, GP05-18-075-DC
MCTR17.45XU25.4A-15	17.45	25.4	272.2	56	310	TOHT08..	GP05-075, GP05-18-075-DC
MCTR17.50XM25A-15	17.5	25	272.2	56	310	TOHT08...	GP05-075, GP05-18-075-DC
MCTR18.00XM25A-15	18	25	287.2	56	327	TOHT08...	GP05-075, GP05-18-075-DC
MCTR18.24XU25.4-15	18.24	25.4	288	56	327	TOHT09..	GP06-085, GP06-20-085-DC
MCTR18.50XM25-15	18.5	25	288	56	327	TOHT09...	GP06-085, GP06-20-085-DC
MCTR18.64XU25.4-15	18.64	25.4	288	56	327	TOHT09..	GP06-085, GP06-20-085-DC
MCTR19.00XM25-15	19	25	303	56	343	TOHT09...	GP06-085, GP06-20-085-DC
MCTR19.05XU25.4-15	19.05	25.4	303	56	343	TOHT09..	GP06-085, GP06-20-085-DC
MCTR19.50XM25-15	19.5	25	303	56	343	TOHT09...	GP06-085, GP06-20-085-DC
MCTR19.94XU31.75-15	19.94	31.75	318	60	360	TOHT09..	GP06-085, GP06-20-085-DC
MCTR20.00XM32-15	20	32	318	60	360	TOHT09...	GP06-085, GP06-20-085-DC
MCTR20.62XU31.75-15	20.62	31.75	318.2	60	360	TOHT10..	GP06-085, GP06-20-085-DC
MCTR21.00XM32-15	21	32	333.2	60	376	TOHT10...	GP06-085, GP06-20-085-DC
MCTR22.00XM32-15	22	32	348.4	60	393	TOHT11...	GP06-100, GP06-20-100-DC
MCTR22.23XU31.75-15	22.23	31.75	348.4	60	393	TOHT11..	GP06-100, GP06-20-100-DC
MCTR23.00XM32-15	23	32	363.4	60	409	TOHT11...	GP06-100, GP06-20-100-DC
MCTR23.80XU31.75-15	23.8	31.75	378.4	60	426	TOHT11..	GP06-100, GP06-20-100-DC
MCTR24.00XM32-15	24	32	378.4	60	426	TOHT11...	GP06-100, GP06-20-100-DC
MCTR25.00XM32-15	25	32	393.4	60	442	TOHT11...	GP06-100, GP06-20-100-DC
MCTR25.40XU31.75-15	25.4	31.75	393.7	60	442	TOHT12..	GP06, GP06-20-120-DC
MCTR26.00XM40-15	26	40	408.7	70	459	TOHT12...	GP06, GP06-20-120-DC
MCTR26.97XU31.75X-15	26.97	31.75	423.7	60	475	TOHT12..	GP06, GP06-20-120-DC
MCTR27.00XM40-15	27	40	423.7	70	475	TOHT12...	GP06, GP06-20-120-DC
MCTR28.00XM40-15	28	40	423.7	70	477	TOHT12...	GP06, GP06-20-120-DC

DC (in)	Tool diameter tolerance (in)	Applicable tolerance range of hole diameter (in)	DC (mm)	Tool diameter tolerance (mm)	Applicable tolerance range of hole diameter (mm)
0.472 - 1.102	0 / - 0.003	+ 0.002 / - 0.004	12 - 13.99	0 / - 0.08	+ 0.05 / - 0.11
			14 - 28	0 / - 0.07	+ 0.05 / - 0.1

## SPARE PARTS

Designation	Insert		Guide pad	
	Screw	Wrench	Screw	Wrench
MCTR12... - MCTR13.5...	SR10503833L040	T-7F	CSPB-2L043	IP-6F
MCTR14... - MCTR20.00...	SR14-560/S	T-8F	SR34-508	T-7F
MCTR20.62... - MCTR21...	SR34-506	T-9F	SR34-508	T-7F
MCTR22... - MCTR25.00...	SR14-571/S	T-10/5	SR34-508	T-7F
MCTR25.4... - MCTR28...	SR14-506	T-15F	SR34-508	T-7F

Recommended clamping torque: CSPB-2L043 = 0.52 lb-ft, SR34-506 = 0.66 lb-ft, SR34-508 = 0.66 lb-ft, SR14-560/S = 0.89 lb-ft, SR10503833L040 = 0.96 lb-ft, SR14-571/S = 3.2 lb-ft, SR14-506 = 3.54 lb-ft

Reference pages: Inserts, Guide pads → **J125 - J128**, Standard cutting conditions → **J130**



# DEEPT<sup>RI</sup> DRILL

## MCTR-F L/D=15

Indexable gun drill, L/D = 15, for lathes and machining centers

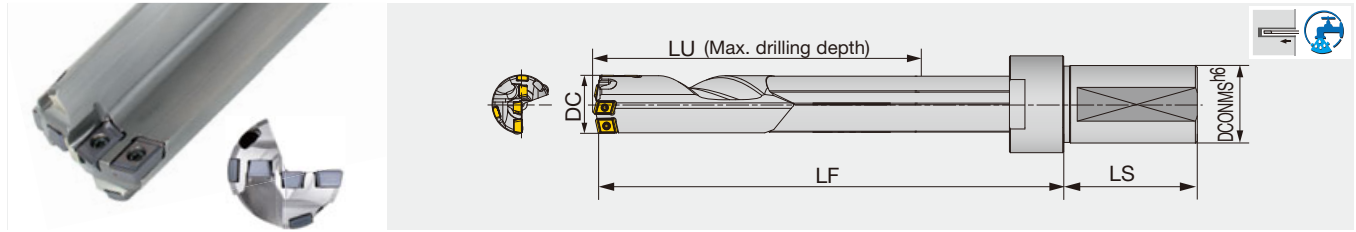

Inch	DC	DCONMS	LU	LS	LF	Insert	Guide pad
MCTR28.58XFU31.75-15	1.125	1.250	17.228	2.717	19.882	FBM07**-C, FBM06**-I, FBH06**-P	GP06, GP06-20-120-DC
MCTR31.75XFU31.75-15	1.250	1.250	19.016	2.717	21.850	FBM07**-C, FBM07**-I, FBH08**-P	GP06, GP06-20-120-DC
MCTR34.93XFU31.75-15	1.375	1.250	20.791	2.717	23.740	FBM07**-C, FBM07**-I, FBH08**-P	GP07, GP07-20-120-DC
MCTR38.10XFU31.75-15	1.500	1.250	23.165	2.717	26.339	FBM08**-C, FBM07**-I, FBH09**-P	GP08, GP08-25-155-DC

Metric	DC	DCONMS	LU	LS	LF	Insert	Guide pad
MCTR28.58XFU31.75-15	28.58	31.75	437.6	69	505	FBM07**-C, FBM06**-I, FBH06**-P	GP06, GP06-20-120-DC
MCTR29.00XFM40-15	29	40	437.6	69	505	FBM07**-C, FBM06**-I, FBH06**-P	GP06, GP06-20-120-DC
MCTR30.00XFM40-15	30	40	467.9	69	538	FBM07**-C, FBM07**-I, FBH08**-P	GP06, GP06-20-120-DC
MCTR31.00XFM40-15	31	40	467.9	69	538	FBM07**-C, FBM07**-I, FBH08**-P	GP06, GP06-20-120-DC
MCTR31.75XFU31.75-15	31.75	31.75	483	69	555	FBM07**-C, FBM07**-I, FBH08**-P	GP06, GP06-20-120-DC
MCTR32.00XFM40-15	32	40	483	69	555	FBM07**-C, FBM07**-I, FBH08**-P	GP06, GP06-20-120-DC
MCTR33.00XFM40-15	33	40	498.1	69	571	FBM07**-C, FBM07**-I, FBH08**-P	GP06, GP06-20-120-DC
MCTR34.00XFM40-15	34	40	513	69	588	FBM07**-C, FBM07**-I, FBH08**-P	GP07, GP07-20-120-DC
MCTR34.93XFU31.75-15	34.93	31.75	528.1	69	603	FBM07**-C, FBM07**-I, FBH08**-P	GP07, GP07-20-120-DC
MCTR35.00XFM40-15	35	40	528.1	69	603	FBM07**-C, FBM07**-I, FBH08**-P	GP07, GP07-20-120-DC
MCTR36.00XFM40-15	36	40	543.1	69	621	FBM08**-C, FBM07**-I, FBH08**-P	GP07, GP07-20-120-DC
MCTR37.00XFM40-15	37	40	558	69	636	FBM08**-C, FBM07**-I, FBH08**-P	GP07, GP07-20-120-DC
MCTR38.00XFM40-15	38	40	573.1	69	654	FBM08**-C, FBM07**-I, FBH08**-P	GP07, GP07-20-120-DC
MCTR38.10XFU31.75-15	38.1	31.75	588.4	69	669	FBM08**-C, FBM07**-I, FBH09**-P	GP08, GP08-25-155-DC
MCTR39.00XFM40-15	39	40	588.4	69	669	FBM08**-C, FBM07**-I, FBH09**-P	GP08, GP08-25-155-DC
MCTR40.00XFM40-15	40	40	603.3	69	687	FBM08**-C, FBM07**-I, FBH09**-P	GP08, GP08-25-155-DC

DC (in)	Tool diameter tolerance (in)	Applicable tolerance range of hole diameter (in)	DC (mm)	Tool diameter tolerance (mm)	Applicable tolerance range of hole diameter (mm)
1.125 - 1.500	0 / - 0.003	+ 0.002 / - 0.004	28.58 - 40	0 / - 0.07	+ 0.05 / - 0.1

Max. DC = 40: Available tailor-made tools

### Caution:

The drill pipe is blackened to increase the resistance to corrosion, and the finished surface may appear uneven. This, however, will not affect the performance of the drill.

### SPARE PARTS

Designation	Insert						Guide pad	
	Central		Intermediate		Peripheral		Screw	Wrench
	Screw	Wrench	Screw	Wrench	Screw	Wrench		
MCTR28.58... - MCTR29...	CSTB-2.5	T-8F	CSTB-2.2	T-7F	CSTB-2.2	T-7F	SR34-508	T-7F
MCTR30... - MCTR33...	CSTB-2.5	T-8F	CSTB-2.5	T-8F	CSTB-2.5	T-8F	SR34-508	T-7F
MCTR34... - MCTR40...	CSTB-2.5	T-8F	CSTB-2.5	T-8F	CSTB-2.5	T-8F	CSTB-3S	T-9F

Recommended clamping torque: SR34-508 = 0.66 lb-ft, CSTB-2.2 = 0.74 lb-ft, CSTB-2.5 = 0.96 lb-ft, CSTB-3S = 1.7 lb-ft

Reference pages: Inserts, Guide pads → **J126 - J128**, Standard cutting conditions → **J130**



# MCTR L/D=20

Indexable gun drill, L/D = 20, for lathes and machining centers

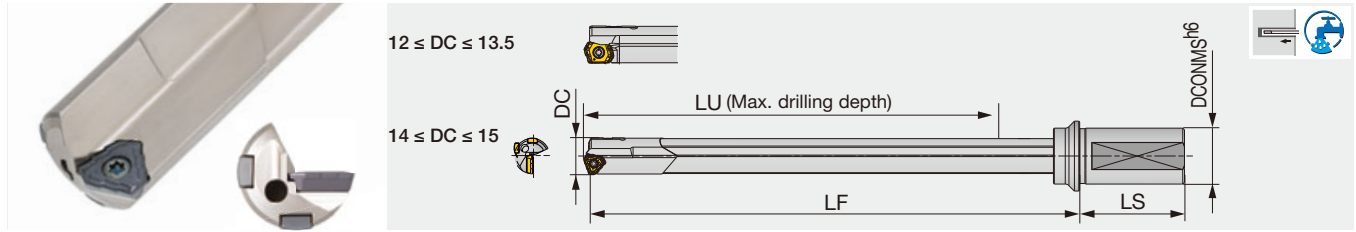

Metric	DC	DCONMS	LU	LS	LF	Insert	Guide pad
MCTR12.00XM20-20	12	20	261.8	50	290	LOGT06...	GP04-055, GP04-16-055-DC
MCTR12.50XM20-20	12.5	20	261.8	50	291	LOGT06...	GP04-055, GP04-16-055-DC
MCTR13.00XM25-20	13	25	281.8	56	315	LOGT06...	GP04-055, GP04-16-055-DC
MCTR13.50XM25-20	13.5	25	281.8	56	315	LOGT06...	GP04-055, GP04-16-055-DC
MCTR14.00XM25-20	14	25	302	56	336	TOHT07...	GP05-060, GP05-18-060-DC
MCTR14.50XM25-20	14.5	25	302	56	337	TOHT07...	GP05-060, GP05-18-060-DC
MCTR15.00XM25-20	15	25	322	56	358	TOHT07...	GP05-060, GP05-18-060-DC

DC (mm)	Tool diameter tolerance (mm)	Applicable tolerance range of hole diameter (mm)
12 - 13.99	0 / - 0.08	+ 0.05 / - 0.11
14 - 15	0 / - 0.07	+ 0.05 / - 0.1

## SPARE PARTS

Designation	Insert		Guide pad	
	Screw	Wrench	Screw	Wrench
MCTR12...-MCTR13.5...	SR10503833L040	T-7F	CSPB-2L043	IP-6F
MCTR14...-MCTR15...	SR14-560/S	T-8F	SR34-508	T-7F

Recommended clamping torque: CSPB-2L043 = 0.7 N·m, SR34-508 = 0.9 N·m, SR14-560/S = 1.2 N·m, SR10503833L040 = 1.3 N·m

Reference pages: Inserts, Guide pads → **J125 - J128**, Standard cutting conditions → **J130**

Grade  
Insert  
Toolholder  
Ext. Toolholder  
Int. Toolholder  
Threading  
Grooving  
Miniature tool  
Milling cutter  
Endmill  
Drilling tool  
Tooling System  
User's Guide  
Index



# DEEPT<sup>RI</sup> DRILL

## MCTR L/D=25

Indexable gun drill, L/D = 25, for lathes and machining centers

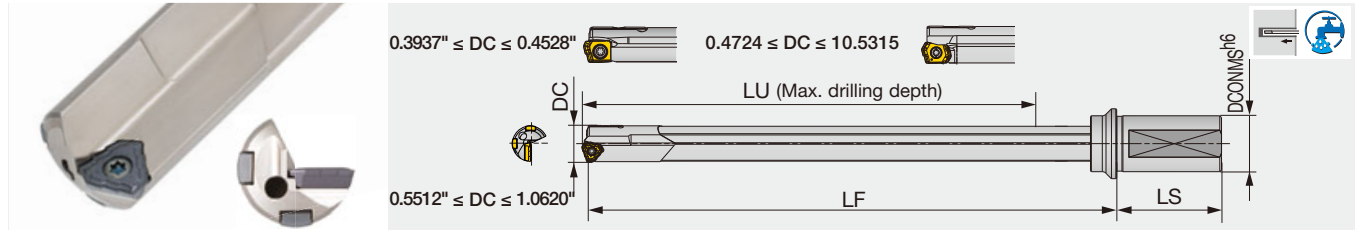

Inch	DC	DCONMS	LU	LS	LF	Insert	Guide pad
MCTR11.11XU19.05-25	0.437	0.75	11.878	1.968	12.953	LOGT06..	GP04-055, GP04-16-055-DC
MCTR12.70XU25.4-25	0.500	1.000	12.866	2.205	14.134	LOGT06..	GP04-055, GP04-16-055-DC
MCTR13.49XU25.4-25	0.531	1.000	13.850	2.205	15.157	LOGT06..	GP04-055, GP04-16-055-DC
MCTR14.27XU25.4-25	0.562	1.000	14.843	2.205	16.181	TOHT07..	GP05-060, GP05-18-060-DC
MCTR15.88XU25.4-25	0.625	1.000	15.827	2.205	17.283	TOHT07..	GP05-060, GP05-18-060-DC
MCTR17.45XU25.4A-25	0.687	1.000	17.803	2.205	19.291	TOHT08..	GP05-075, GP05-18-075-DC
MCTR18.24XU25.4-25	0.718	1.000	18.819	2.205	20.354	TOHT09..	GP06-085, GP06-20-085-DC
MCTR18.64XU25.4-25	0.734	1.000	18.819	2.205	20.354	TOHT09..	GP06-085, GP06-20-085-DC
MCTR19.05XU25.4-25	0.750	1.000	19.803	2.205	21.378	TOHT09..	GP06-085, GP06-20-085-DC
MCTR19.94XU31.75-25	0.785	1.250	20.787	2.362	22.441	TOHT09..	GP06-085, GP06-20-085-DC
MCTR20.62XU31.75-25	0.812	1.250	20.795	2.362	22.441	TOHT10..	GP06-085, GP06-20-085-DC
MCTR21.46XU31.75-25	0.845	1.250	21.78	2.362	23.465	TOHT10...	GP06-100, GP06-20-100-DC
MCTR22.23XU31.75-25	0.875	1.250	22.772	2.362	24.528	TOHT11..	GP06-100, GP06-20-100-DC
MCTR23.80XU31.75-25	0.937	1.250	24.740	2.362	26.614	TOHT11..	GP06-100, GP06-20-100-DC
MCTR25.40XU31.75-25	1.000	1.250	25.732	2.362	27.638	TOHT12..	GP06, GP06-20-120-DC
MCTR26.97XU31.75X-25	1.062	1.250	27.701	2.362	29.724	TOHT12..	GP06, GP06-20-120-DC
MCTR26.97XU38.1-25	1.062	1.500	27.701	2.756	29.724	TOHT12...	GP06, GP06-20-120-DC

DC (in)	Tool diameter tolerance (in)	Applicable tolerance range of hole diameter (in)
0.437 - 1.102	0 / - 0.003	+ 0.002 / - 0.004

### SPARE PARTS

Designation	Insert		Guide pad	
	Screw	Wrench	Screw	Wrench
MCTR11... - MCTR13.5...	SR10503833L040	T-7F	CSPB-2L043	IP-6F
MCTR14... - MCTR20.00...	SR14-560/S	T-8F	SR34-508	T-7F
MCTR20.62... - ...MCTR21...	SR34-506	T-9F	SR34-508	T-7F
MCTR22... - MCTR25.00...	SR14-571/S	T-10/5	SR34-508	T-7F
MCTR25.4... - MCTR28...	SR14-506	T-15F	SR34-508	T-7F

Recommended clamping torque: CSPB-2L043 = 0.52 lb-ft, SR34-506 = 0.66 lb-ft, SR34-508 = 0.66 lb-ft, SR14-560/S = 0.89 lb-ft, SR10503833L040 = 0.96 lb-ft, SR14-571/S = 2.36 lb-ft, SR14-506 = 3.54 lb-ft

Reference pages: Inserts, Guide pads → **J125 - J128**, Standard cutting conditions → **J130**

# MCTR L/D=25

Indexable gun drill, L/D = 25, for lathes and machining centers

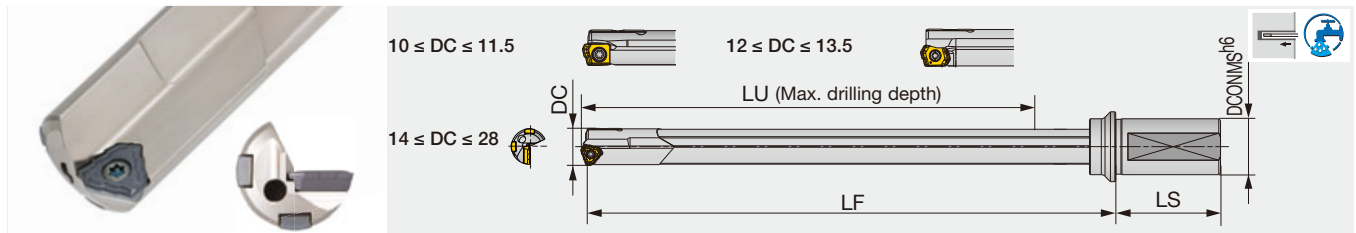

Metric	DC	DCONMS	LU	LS	LF	Insert	Guide pad
MCTR10.00XM20-25	10	20	264.2	50	289.5	ZSGT06...	GP04-16-045-DC
MCTR11.00XM20-25	11	20	301.7	50	329	ZSGT06...	GP04-16-050-DC
MCTR11.50XM20-25	11.5	20	301.7	50	329	ZSGT06...	GP04-16-050-DC
MCTR12.00XM20-25	12	20	326.8	50	355	LOGT06...	GP04-055, GP04-16-055-DC
MCTR12.50XM20-25	12.5	20	326.8	50	356	LOGT06...	GP04-055, GP04-16-055-DC
MCTR12.70XU25.4-25	12.7	25.4	326.8	56	359	LOGT06...	GP04-055, GP04-16-055-DC
MCTR13.00XM25-25	13	25	351.8	56	385	LOGT06...	GP04-055, GP04-16-055-DC
MCTR13.49XU25.4-25	13.49	25.4	351.8	56	385	LOGT06...	GP04-055, GP04-16-055-DC
MCTR13.50XM25-25	13.5	25	351.8	56	385	LOGT06...	GP04-055, GP04-16-055-DC
MCTR14.00XM25-25	14	25	377	56	411	TOHT07...	GP05-060, GP05-18-060-DC
MCTR14.27XU25.4-25	14.27	25.4	377	56	411	TOHT07...	GP05-060, GP05-18-060-DC
MCTR14.50XM25-25	14.5	25	377	56	412	TOHT07...	GP05-060, GP05-18-060-DC
MCTR15.00XM25-25	15	25	402	56	438	TOHT07...	GP05-060, GP05-18-060-DC
MCTR15.88XU25.4-25	15.88	25.4	402	56	439	TOHT07...	GP05-060, GP05-18-060-DC
MCTR16.00XM25A-25	16	25	427.2	56	464	TOHT08...	GP05-075, GP05-18-075-DC
MCTR16.50XM25A-25	16.5	25	427.2	56	464	TOHT08...	GP05-075, GP05-18-075-DC
MCTR17.00XM25A-25	17	25	452.2	56	490	TOHT08...	GP05-075, GP05-18-075-DC
MCTR17.45XU25.4A-25	17.45	25.4	452.2	56	490	TOHT08...	GP05-075, GP05-18-075-DC
MCTR17.50XM25A-25	17.5	25	452.2	56	490	TOHT08...	GP05-075, GP05-18-075-DC
MCTR18.00XM25A-25	18	25	477.2	56	517	TOHT08...	GP05-075, GP05-18-075-DC
MCTR18.24XU25.4-25	18.24	25.4	478	56	517	TOHT09...	GP06-085, GP06-20-085-DC
MCTR18.50XM25-25	18.5	25	478	56	517	TOHT09...	GP06-085, GP06-20-085-DC
MCTR18.64XU25.4-25	18.64	25.4	478	56	517	TOHT09...	GP06-085, GP06-20-085-DC
MCTR19.00XM25-25	19	25	503	56	543	TOHT09...	GP06-085, GP06-20-085-DC
MCTR19.05XU25.4-25	19.05	25.4	503	56	543	TOHT09...	GP06-085, GP06-20-085-DC
MCTR19.50XM25-25	19.5	25	503	56	543	TOHT09...	GP06-085, GP06-20-085-DC
MCTR19.94XU31.75-25	19.94	31.75	528	60	570	TOHT09...	GP06-085, GP06-20-085-DC
MCTR20.00XM32-25	20	32	528	60	570	TOHT09...	GP06-085, GP06-20-085-DC
MCTR20.62XU31.75-25	20.62	31.75	528.2	60	570	TOHT10...	GP06-085, GP06-20-085-DC
MCTR21.00XM32-25	21	32	553.2	60	596	TOHT10...	GP06-085, GP06-20-085-DC
MCTR22.00XM32-25	22	32	578.4	60	623	TOHT11...	GP06-100, GP06-20-100-DC
MCTR22.23XU31.75-25	22.23	31.75	578.4	60	623	TOHT11...	GP06-100, GP06-20-100-DC
MCTR23.00XM32-25	23	32	603.4	60	649	TOHT11...	GP06-100, GP06-20-100-DC
MCTR23.80XU31.75-25	23.8	31.75	628.4	60	676	TOHT11...	GP06-100, GP06-20-100-DC
MCTR24.00XM32-25	24	32	628.4	60	676	TOHT11...	GP06-100, GP06-20-100-DC
MCTR25.00XM32-25	25	32	653.4	60	702	TOHT11...	GP06-100, GP06-20-100-DC
MCTR25.40XU31.75-25	25.4	31.75	653.7	60	702	TOHT12...	GP06, GP06-20-120-DC
MCTR26.00XM40-25	26	40	678.7	70	729	TOHT12...	GP06, GP06-20-120-DC
MCTR26.97XU31.75X-25	26.97	31.75	703.7	60	755	TOHT12...	GP06, GP06-20-120-DC
MCTR27.00XM40-25	27	40	703.7	70	755	TOHT12...	GP06, GP06-20-120-DC
MCTR28.00XM40-25	28	40	703.7	70	757	TOHT12...	GP06, GP06-20-120-DC

DC (mm)	Tool diameter tolerance (mm)	Applicable tolerance range of hole diameter (mm)
10 - 13.99	0 / - 0.08	+ 0.05 / - 0.11
14 - 28	0 / - 0.07	+ 0.05 / - 0.1

Reference pages: Inserts, Guide pads → **J125 - J128**, Standard cutting conditions → **J130**

Grade  
Insert  
Toolholder  
Ext. Toolholder  
Int. Toolholder  
Threading  
Grooving  
Milling cutter  
Miniature tool  
Endmill  
Drilling tool  
Tooling System  
User's Guide  
Index



# DEEPT<sup>RI</sup> DRILL

## MCTR-F L/D=25

Indexable gun drill, L/D = 25, for lathes and machining centers

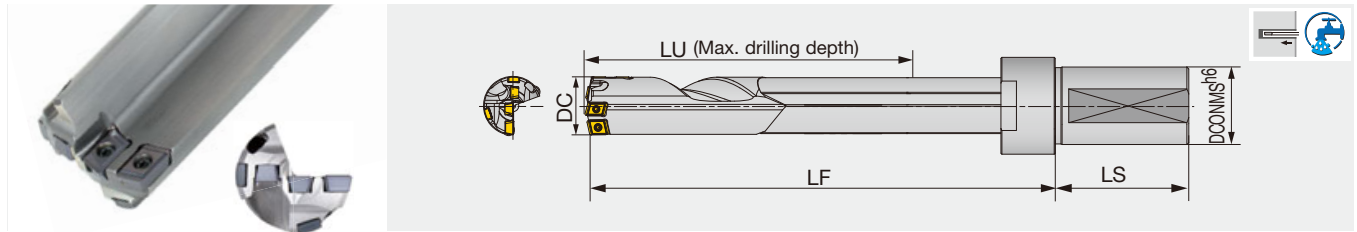

Inch	DC	DCONMS	LU	LS	LF	Insert	Guide pad
MCTR28.58XFU31.75-25	1.125	1.250	31.614	2.717	31.299	FBM07**-C, FBM06**-I, FBH06**-P	GP06, GP06-20-120-DC
MCTR31.75XFU31.75-25	1.250	1.250	34.571	2.717	34.449	FBM07**-C, FBM07**-I, FBH08**-P	GP06, GP06-20-120-DC
MCTR34.93XFU31.75-25	1.375	1.250	38.520	2.717	37.520	FBM07**-C, FBM07**-I, FBH08**-P	GP07, GP07-20-120-DC
MCTR38.10XFU31.75-25	1.500	1.250	978.40	2.717	41.693	FBM08**-C, FBM07**-I, FBH09**-P	GP08, GP08-25-155-DC

Metric	DC	DCONMS	LU	LS	LF	Insert	Guide pad
MCTR30.00XFM40-25	30	40	777.9	69	848	FBM07**-C, FBM07**-I, FBH08**-P	GP06, GP06-20-120-DC

DC (in)	Tool diameter tolerance (in)	Applicable tolerance range of hole diameter (in)	DC (mm)	Tool diameter tolerance (mm)	Applicable tolerance range of hole diameter (mm)
1.125 - 1.500	0 / - 0.003	+ 0.002 / - 0.004	28.58 - 38.1	0 / - 0.07	+ 0.05 / - 0.1

Caution:  
The drill pipe is blackened to increase the resistance to corrosion, and the finished surface may appear uneven. This, however, will not affect the performance of the drill.

### SPARE PARTS

Designation	Insert						Guide pad	
	Central		Intermediate		Peripheral		Screw	Wrench
	Screw	Wrench	Screw	Wrench	Screw	Wrench		
MCTR28.58... - MCTR29...	CSTB-2.5	T-8F	CSTB-2.2	T-7F	CSTB-2.2	T-7F	SR34-508	T-7F
MCTR30... - MCTR33...	CSTB-2.5	T-8F	CSTB-2.5	T-8F	CSTB-2.5	T-8F	SR34-508	T-7F
MCTR33.1... - MCTR40...	CSTB-2.5	T-8F	CSTB-2.5	T-8F	CSTB-2.5	T-8F	CSTB-3S	T-9F

Recommended clamping torque : CSTB-2.5 = 0.96 lb-ft, CSTB-2.2 = 0.74 lb-ft, SR34-508 = 0.66 lb-ft, CSTB-3S = 1.7 lb-ft

Reference pages: Inserts, Guide pads → **J126 - J128**, Standard cutting conditions → **J130**

# MCTRCH L/D=25

Indexable gun drill, L/D = 25, for drilling cross hole applications on CNC lathes and machining centers

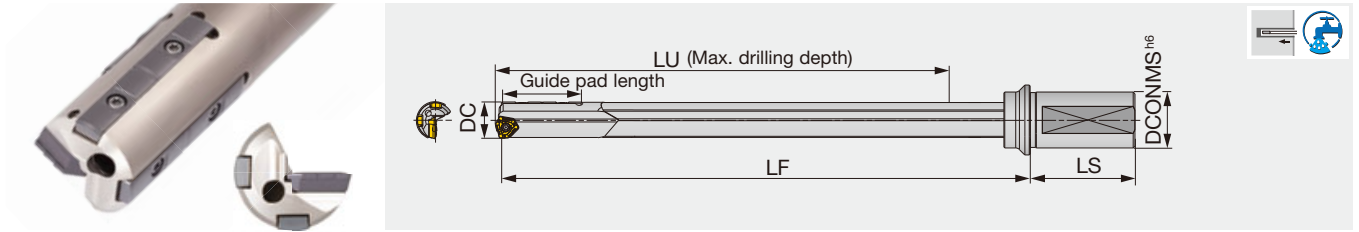

Inch	DC	DCONMS	LU	LS	LF	Insert	Guide pad	Guide pad length
MCTRCH14.68XU25.4-25	0.578	1.000	14.843	2.205	16.220	TOHT07...	GP05-060, GP05-18-060-DC	1.417
MCTRCH15.06XU25.4-25	0.593	1.000	15.827	2.205	17.244	TOHT07...	GP05-060, GP05-18-060-DC	1.417
MCTRCH18.24XU25.4-25	0.718	1.000	18.819	2.205	20.354	TOHT09...	GP06-085, GP06-20-085-DC	1.575
MCTRCH18.64XU25.4-25	0.734	1.000	18.819	2.205	20.354	TOHT09...	GP06-085, GP06-20-085-DC	1.575
MCTRCH23.80XU31.75-25	0.937	1.250	24.740	2.362	26.614	TOHT11...	GP06-100, GP06-20-100-DC	1.575

Metric	DC	DCONMS	LU	LS	LF	Insert	Guide pad	Guide pad length
MCTRCH14.00XM25-25	14	25	377	56	411	TOHT07...	GP05-060, GP05-18-060-DC	36
MCTRCH14.68XU25.4-25	14.68	25.4	377	56	412	TOHT07...	GP05-060, GP05-18-060-DC	36
MCTRCH15.00XM25-25	15	25	402	56	438	TOHT07...	GP05-060, GP05-18-060-DC	36
MCTRCH15.06XU25.4-25	15.06	25.4	402	56	438	TOHT07...	GP05-060, GP05-18-060-DC	36
MCTRCH16.00XM25A-25	16	25	427.2	56	464	TOHT08...	GP05-075, GP05-18-075-DC	36
MCTRCH18.00XM25A-25	18	25	477.2	56	517	TOHT08...	GP05-075, GP05-18-075-DC	36
MCTRCH18.24XU25.4-25	18.24	25.4	478	56	517	TOHT09...	GP06-085, GP06-20-085-DC	40
MCTRCH18.64XU25.4-25	18.64	25.4	478	56	517	TOHT09...	GP06-085, GP06-20-085-DC	40
MCTRCH19.00XM25-25	19	25	503	56	543	TOHT09...	GP06-085, GP06-20-085-DC	40
MCTRCH20.00XM32-25	20	32	528	60	570	TOHT09...	GP06-085, GP06-20-085-DC	40
MCTRCH23.00XM32-25	23	32	603.4	60	649	TOHT11...	GP06-100, GP06-20-100-DC	40
MCTRCH23.80XU31.75-25	23.8	31.75	628.4	60	676	TOHT11...	GP06-100, GP06-20-100-DC	40
MCTRCH24.00XM32-25	24	32	628.4	60	676	TOHT11...	GP06-100, GP06-20-100-DC	40
MCTRCH28.00XM40-25	28	40	703.7	70	757	TOHT12...	GP06, GP06-20-120-DC	40

DC (in)	Tool diameter tolerance (in)	Applicable tolerance range of hole diameter (in)	DC (mm)	Tool diameter tolerance (mm)	Applicable tolerance range of hole diameter (mm)
0.578 - 0.937	0 / - 0.003	+ 0.002 / - 0.004	14 - 28	0 / - 0.09	+ 0.05 / - 0.12

## SPARE PARTS

Designation	Insert		Guide pad	
	Screw	Wrench	Screw	Wrench
MCTRCH14... - MCTRCH20...	SR14-560/S	T-8F	SR34-508	T-7F
MCTRCH23... - MCTRCH24...	SR14-571/S	T-10/5	SR34-508	T-7F
MCTRCH28...	SR14-506	T-15F	SR34-508	T-7F

Recommended clamping torque: SR34-508 = 0.66 lb-ft, SR14-560/S = 0.89 lb-ft, SR14-571/S = 2.36 lb-ft, SR14-506 = 3.54 lb-ft

Reference pages: Inserts, Guide pads → **J125 - J128**, Standard cutting conditions → **J130**

## ■ Tool selection with regard to cross hole diameters and drill diameters

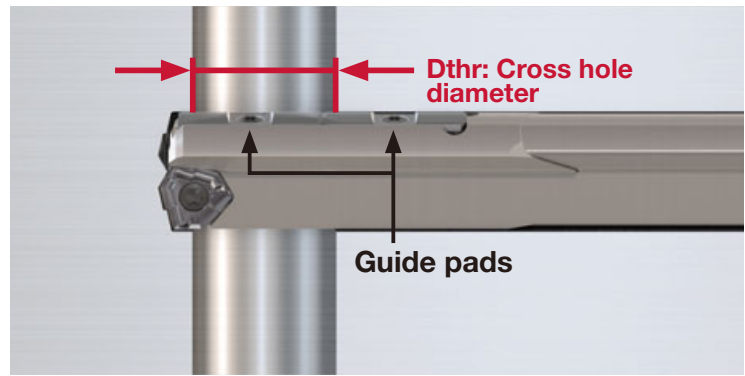
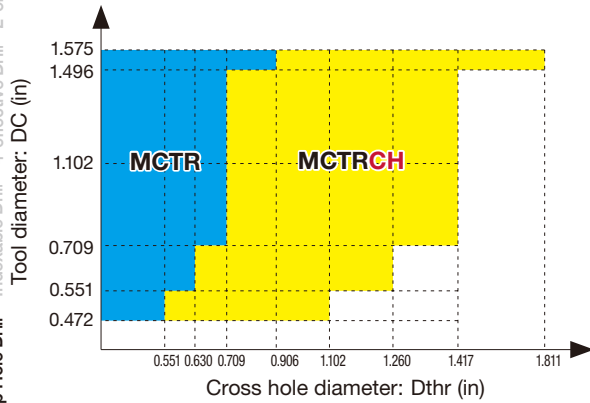

Note: An MCTR drill can be used when the cross hole diameter (Dthr) is smaller than the drill's guide pad length.  
When the cross hole diameter is larger than the drill's guide pad length, use an MCTRCH drill.

## DEEPT<sup>RI</sup> DRILL MCTR L/D=35, 40, 45

Indexable gun drill, L/D = 35, 40, 45, for lathes and machining centers

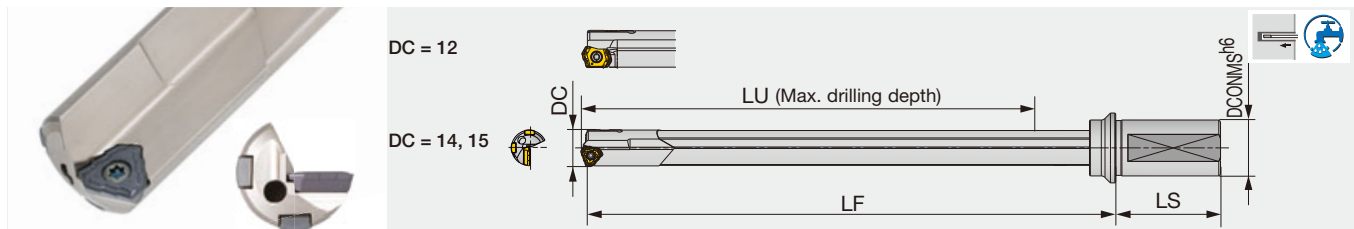

Inch	DC	L/D	DCONMS	LU	LS	LF	Insert	Guide pad
MCTR11.11XU19.05-35	0.4374	35	0.750	16.602	1.968	17.677	LOGT06...	GP04-055, GP04-16-055-DC
MCTR11.11XU19.05-45	0.4374	40	0.750	21.327	1.968	22.402	LOGT06...	GP04-055, GP04-16-055-DC
Metric	DC	L/D	DCONMS	LU	LS	LF	Insert	Guide pad
MCTR12.00XM20-35	12	35	20	456.8	50	485	LOGT06...	GP04-055, GP04-16-055-DC
MCTR12.00XM20-40	12	40	20	521.8	50	550	LOGT06...	GP04-055, GP04-16-055-DC
MCTR12.00XM20-45	12	45	20	586.8	50	615	LOGT06...	GP04-055, GP04-16-055-DC
MCTR14.00XM25-35	14	35	25	527	56	561	TOHT07...	GP05-060, GP05-18-060-DC
MCTR14.00XM25-40	14	40	25	602	56	636	TOHT07..	GP05-060, GP05-18-060-DC
MCTR15.00XM25-35	15	35	25	562	56	598	TOHT07...	GP05-060, GP05-18-060-DC
MCTR15.00XM25-40	15	40	25	642	56	678	TOHT07...	GP05-060, GP05-18-060-DC

DC (in)	Tool diameter tolerance (in)	Applicable tolerance range of hole diameter (in)	DC (mm)	Tool diameter tolerance (mm)	Applicable tolerance range of hole diameter (mm)
0.4374	0 / - 0.003	+ 0.002 / - 0.004	12 - 13.99	0 / - 0.08	+ 0.05 / - 0.11
			14 - 15	0 / - 0.07	+ 0.05 / - 0.1

### SPARE PARTS

Designation	Insert		Guide pad	
	Screw	Wrench	Screw	Wrench
MCTR10... - MCTR11.5...	SR-M2.5X0.35L3.8	T-7F	CSTB-2	T-6F
MCTR12... - MCTR13.5...	SR10503833L040	T-7F	CSPB-2L043	IP-6F
MCTR14... - MCTR20...	SR14-560/S	T-8F	SR34-508	T-7F
MCTR20.62... - MCTR21...	SR34-506	T-9F	SR34-508	T-7F
MCTR22... - MCTR25...	SR14-571/S	T-10/5	SR34-508	T-7F
MCTR25.4... - MCTR28...	SR14-506	T-15F	SR34-508	T-7F

Recommended clamping torque: SR-M2.5X0.35L3.8 = 0.66 lb-ft, CSTB-2 = 0.52 lb-ft, SR10503833L040 = 0.96 lb-ft, CSPB-2L043 = 0.52 lb-ft, SR14-560/S = 0.89 lb-ft, SR34-508 = 0.66 lb-ft, SR34-506 = 0.66 lb-ft, SR14-571/S = 2.36 lb-ft, SR14-506 = 3.54 lb-ft

Reference pages: Inserts, Guide pads → **J125 - J128**, Standard cutting conditions → **J130**



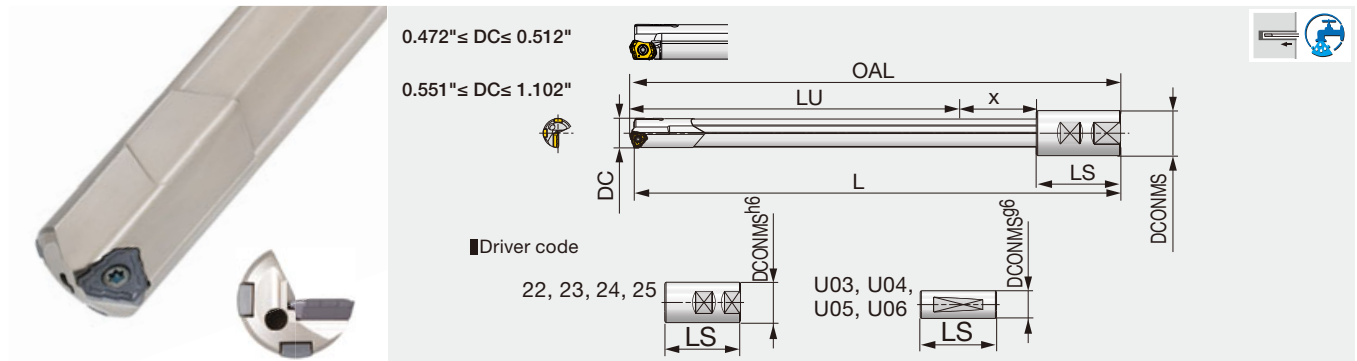

Inch	DC	L	DCONMS	LU	OAL	LS	x	Driver code	Insert	Guide pad
TRLG12.70X1219-U04	0.500	47.992	1.000	44.559	48.063	2.756	0.748	U04	LOGT06..	GP04-055, GP04-16-055-DC
TRLG12.70X1524-U04	0.500	60.000	1.000	56.567	60.071	2.756	0.748	U04	LOGT06..	GP04-055, GP04-16-055-DC
TRLG13.49X1219-U04	0.531	47.992	1.000	44.520	48.063	2.756	0.787	U04	LOGT06..	GP04-055, GP04-16-055-DC
TRLG13.49X1527-U04	0.531	60.118	1.000	56.646	60.189	2.756	0.787	U04	LOGT06..	GP04-055, GP04-16-055-DC

Metric	DC	L	DCONMS	LU	OAL	LS	x	Driver code	Insert	Guide pad
TRLG12.00X800-U03	12	800	19.05	713.8	801.8	70	18	U03	LOGT06...	GP04-055, GP04-16-055-DC
TRLG12.00X800-22	12	800	20	733.8	801.8	50	18	22	LOGT06...	GP04-055, GP04-16-055-DC
TRLG12.00X1000-U03	12	1000	19.05	913.8	1001.8	70	18	U03	LOGT06...	GP04-055, GP04-16-055-DC
TRLG12.00X1000-22	12	1000	20	933.8	1001.8	50	18	22	LOGT06...	GP04-055, GP04-16-055-DC
TRLG12.00X1650-U03	12	1650	19.05	1563.8	1651.8	70	18	U03	LOGT06...	GP04-055, GP04-16-055-DC
TRLG12.00X1650-22	12	1650	20	1583.8	1651.8	50	18	22	LOGT06...	GP04-055, GP04-16-055-DC
TRLG12.70X1219-U04	12.7	1219	25.4	1131.8	1220.8	70	19	U04	LOGT06..	GP04-055, GP04-16-055-DC
TRLG12.70X1524-U04	12.7	1524	25.4	1436.8	1525.8	70	19	U04	LOGT06..	GP04-055, GP04-16-055-DC
TRLG13.00X800-U04	13	800	25.4	711.8	801.8	70	20	U04	LOGT06...	GP04-055, GP04-16-055-DC
TRLG13.00X800-23	13	800	25	725.8	801.8	56	20	23	LOGT06...	GP04-055, GP04-16-055-DC
TRLG13.00X1000-U04	13	1000	25.4	911.8	1001.8	70	20	U04	LOGT06...	GP04-055, GP04-16-055-DC
TRLG13.00X1000-23	13	1000	25	925.8	1001.8	56	20	23	LOGT06...	GP04-055, GP04-16-055-DC
TRLG13.00X1650-U04	13	1650	25.4	1561.8	1651.8	70	20	U04	LOGT06...	GP04-055, GP04-16-055-DC
TRLG13.00X1650-23	13	1650	25	1575.8	1651.8	56	20	23	LOGT06...	GP04-055, GP04-16-055-DC
TRLG13.49X1219-U04	13.49	1219	25.4	1130.8	1220.8	70	20	U04	LOGT06..	GP04-055, GP04-16-055-DC
TRLG13.49X1527-U04	13.49	1527	25.4	1438.8	1528.8	70	20	U04	LOGT06..	GP04-055, GP04-16-055-DC
TRLG14.00X800-23	14	800	25	725	802	56	21	23	TOHT07...	GP05-060, GP05-18-060-DC
TRLG14.00X800-U04	14	800	25.4	711	802	70	21	U04	TOHT07...	GP05-060, GP05-18-060-DC
TRLG14.00X1000-23	14	1000	25	925	1002	56	21	23	TOHT07...	GP05-060, GP05-18-060-DC
TRLG14.00X1000-U04	14	1000	25.4	911	1002	70	21	U04	TOHT07...	GP05-060, GP05-18-060-DC
TRLG14.00X1650-23	14	1650	25	1575	1652	56	21	23	TOHT07...	GP05-060, GP05-18-060-DC
TRLG14.00X1650-U04	14	1650	25.4	1561	1652	70	21	U04	TOHT07...	GP05-060, GP05-18-060-DC
TRLG14.50X800-23	14.5	800	25	724	802	56	22	23	TOHT07...	GP05-060, GP05-18-060-DC
TRLG14.50X800-U04	14.5	800	25.4	710	802	70	22	U04	TOHT07...	GP05-060, GP05-18-060-DC
TRLG14.50X1000-23	14.5	1000	25	924	1002	56	22	23	TOHT07...	GP05-060, GP05-18-060-DC
TRLG14.50X1000-U04	14.5	1000	25.4	910	1002	70	22	U04	TOHT07...	GP05-060, GP05-18-060-DC
TRLG14.50X1650-23	14.5	1650	25	1574	1652	56	22	23	TOHT07...	GP05-060, GP05-18-060-DC
TRLG14.50X1650-U04	14.5	1650	25.4	1560	1652	70	22	U04	TOHT07...	GP05-060, GP05-18-060-DC
TRLG15.00X800-23	15	800	25	723	802	56	23	23	TOHT07...	GP05-060, GP05-18-060-DC
TRLG15.00X800-U04	15	800	25.4	709	802	70	23	U04	TOHT07...	GP05-060, GP05-18-060-DC
TRLG15.00X1000-23	15	1000	25	923	1002	56	23	23	TOHT07...	GP05-060, GP05-18-060-DC
TRLG15.00X1000-U04	15	1000	25.4	909	1002	70	23	U04	TOHT07...	GP05-060, GP05-18-060-DC
TRLG15.00X1650-23	15	1650	25	1573	1652	56	23	23	TOHT07...	GP05-060, GP05-18-060-DC
TRLG15.00X1650-U04	15	1650	25.4	1559	1652	70	23	U04	TOHT07...	GP05-060, GP05-18-060-DC
TRLG16.00X800-23A	16	800	25	722.2	802.2	56	24	23	TOHT08...	GP05-075, GP05-18-075-DC
TRLG16.00X800-U04A	16	800	25.4	708.2	802.2	70	24	U04	TOHT08...	GP05-075, GP05-18-075-DC
TRLG16.00X1000-23A	16	1000	25	922.2	1002.2	56	24	23	TOHT08...	GP05-075, GP05-18-075-DC
TRLG16.00X1000-U04A	16	1000	25.4	908.2	1002.2	70	24	U04	TOHT08...	GP05-075, GP05-18-075-DC
TRLG16.00X1500-23A	16	1500	25	1422.2	1502.2	56	24	23	TOHT08...	GP05-075, GP05-18-075-DC
TRLG16.00X1500-U04A	16	1500	25.4	1408.2	1502.2	70	24	U04	TOHT08...	GP05-075, GP05-18-075-DC
TRLG17.00X800-23A	17	800	25	721.2	802.2	56	25	23	TOHT08...	GP05-075, GP05-18-075-DC
TRLG17.00X800-U04A	17	800	25.4	707.2	802.2	70	25	U04	TOHT08...	GP05-075, GP05-18-075-DC
TRLG17.00X1000-23A	17	1000	25	921.2	1002.2	56	25	23	TOHT08...	GP05-075, GP05-18-075-DC
TRLG17.00X1000-U04A	17	1000	25.4	907.2	1002.2	70	25	U04	TOHT08...	GP05-075, GP05-18-075-DC





Metric	DC	L	DCONMS	LU	OAL	LS	x	Driver code	Insert	Guide pad
TRLG18.00X800-23A	18	800	25	719.2	802.2	56	27	23	TOHT08...	GP05-075, GP05-18-075-DC
TRLG18.00X800-U04A	18	800	25.4	705.2	802.2	70	27	U04	TOHT08...	GP05-075, GP05-18-075-DC
TRLG18.00X1000-23A	18	1000	25	919.2	1002.2	56	27	23	TOHT08...	GP05-075, GP05-18-075-DC
TRLG18.00X1000-U04A	18	1000	25.4	905.2	1002.2	70	27	U04	TOHT08...	GP05-075, GP05-18-075-DC
TRLG18.00X1500-23A	18	1500	25	1419.2	1502.2	56	27	23	TOHT08...	GP05-075, GP05-18-075-DC
TRLG18.00X1500-U04A	18	1500	25.4	1405.2	1502.2	70	27	U04	TOHT08...	GP05-075, GP05-18-075-DC
TRLG18.50X1500-23	18.5	1500	25	1420	1503	56	27	23	TOHT09...	GP06-085, GP06-20-085-DC
TRLG18.50X1500-U04	18.5	1500	25.4	1406	1503	70	27	U04	TOHT09...	GP06-085, GP06-20-085-DC
TRLG19.00X800-23	19	800	25	719	803	56	28	23	TOHT09...	GP06-085, GP06-20-085-DC
TRLG19.00X800-U04	19	800	25.4	705	803	70	28	U04	TOHT09...	GP06-085, GP06-20-085-DC
TRLG19.00X1000-23	19	1000	25	919	1003	56	28	23	TOHT09...	GP06-085, GP06-20-085-DC
TRLG19.00X1000-U04	19	1000	25.4	905	1003	70	28	U04	TOHT09...	GP06-085, GP06-20-085-DC
TRLG20.00X800-24	20	800	32	713	803	60	30	24	TOHT09...	GP06-085, GP06-20-085-DC
TRLG20.00X800-U05	20	800	31.75	703	803	70	30	U05	TOHT09...	GP06-085, GP06-20-085-DC
TRLG20.00X1000-24	20	1000	32	913	1003	60	30	24	TOHT09...	GP06-085, GP06-20-085-DC
TRLG20.00X1000-U05	20	1000	31.75	903	1003	70	30	U05	TOHT09...	GP06-085, GP06-20-085-DC
TRLG21.00X1000-24	21	1000	32	912.2	1003.2	60	31	24	TOHT10...	GP06-085, GP06-20-085-DC
TRLG21.00X1000-U05	21	1000	31.75	902.2	1003.2	70	31	U05	TOHT10...	GP06-085, GP06-20-085-DC
TRLG22.00X1000-24	22	1000	32	910.4	1003.4	60	33	24	TOHT11...	GP06-100, GP06-20-100-DC
TRLG22.00X1000-U05	22	1000	31.75	900.4	1003.4	70	33	U05	TOHT11...	GP06-100, GP06-20-100-DC
TRLG22.00X1500-24	22	1500	32	1410.4	1503.4	60	33	24	TOHT11...	GP06-100, GP06-20-100-DC
TRLG22.00X1500-U05	22	1500	31.75	1400.4	1503.4	70	33	U05	TOHT11...	GP06-100, GP06-20-100-DC
TRLG23.00X1000-24	23	1000	32	909.4	1003.4	60	34	24	TOHT11...	GP06-100, GP06-20-100-DC
TRLG23.00X1000-U05	23	1000	31.75	899.4	1003.4	70	34	U05	TOHT11...	GP06-100, GP06-20-100-DC
TRLG23.00X1500-24	23	1500	32	1409.4	1503.4	60	34	24	TOHT11...	GP06-100, GP06-20-100-DC
TRLG23.00X1500-U05	23	1500	31.75	1399.4	1503.4	70	34	U05	TOHT11...	GP06-100, GP06-20-100-DC
TRLG24.00X1000-24	24	1000	32	907.4	1003.4	60	36	24	TOHT11...	GP06-100, GP06-20-100-DC
TRLG24.00X1000-U05	24	1000	31.75	897.4	1003.4	70	36	U05	TOHT11...	GP06-100, GP06-20-100-DC
TRLG24.00X1500-24	24	1500	32	1407.4	1503.4	60	36	24	TOHT11...	GP06-100, GP06-20-100-DC
TRLG24.00X1500-U05	24	1500	31.75	1397.4	1503.4	70	36	U05	TOHT11...	GP06-100, GP06-20-100-DC
TRLG25.00X1000-24	25	1000	32	906.4	1003.4	60	37	24	TOHT11...	GP06-100, GP06-20-100-DC
TRLG25.00X1000-U05	25	1000	31.75	896.4	1003.4	70	37	U05	TOHT11...	GP06-100, GP06-20-100-DC
TRLG26.00X1000-25	26	1000	40	894.7	1003.7	70	39	25	TOHT12...	GP06, GP06-20-120-DC
TRLG26.00X1000-U06	26	1000	38.1	894.7	1003.7	70	39	U06	TOHT12...	GP06, GP06-20-120-DC
TRLG27.00X1000-25	27	1000	40	893.7	1003.7	70	40	25	TOHT12...	GP06, GP06-20-120-DC
TRLG27.00X1000-U06	27	1000	38.1	893.7	1003.7	70	40	U06	TOHT12...	GP06, GP06-20-120-DC
TRLG28.00X1000-25	28	1000	40	891.7	1003.7	70	42	25	TOHT12...	GP06, GP06-20-120-DC
TRLG28.00X1000-U06	28	1000	38.1	891.7	1003.7	70	42	U06	TOHT12...	GP06, GP06-20-120-DC

DC (in)	Tool diameter tolerance (in)	Applicable tolerance range of hole diameter (in)	DC (mm)	Tool diameter tolerance (mm)	Applicable tolerance range of hole diameter (mm)
0.472 - 1.102	0 / - 0.003	+ 0.002 / - 0.004	12 - 13.99	0 / - 0.08	+ 0.05 / - 0.11
			14 - 28	0 / - 0.07	+ 0.05 / - 0.1

### SPARE PARTS



Designation	Insert		Guide pad	
	Screw	Wrench	Screw	Wrench
TRLG12... - TRLG13...	SR10503833L040	T-7F	CSPB-2L043	IP-6F
TRLG14... - TRLG20...	SR14-560/S	T-8F	SR34-508	T-7F
TRLG21...	SR34-506	T-9F	SR34-508	T-7F
TRLG22... - TRLG25...	SR14-571/S	T-10/5	SR34-508	T-7F
TRLG26... - TRLG28...	SR14-506	T-15F	SR34-508	T-7F

Recommended clamping torque : CSPB-2L043 = 0.52 lb-ft, SR34-508 = 0.66 lb-ft, SR34-506 = 0.66 lb-ft, SR14-560/S = 0.89 lb-ft, SR10503833L040 = 0.96 lb-ft, SR14-571/S = 2.36 lb-ft, SR14-506 = 3.54 lb-ft

Reference pages: Inserts, Guide pads → **J125 - J128**, Standard cutting conditions → **J130**

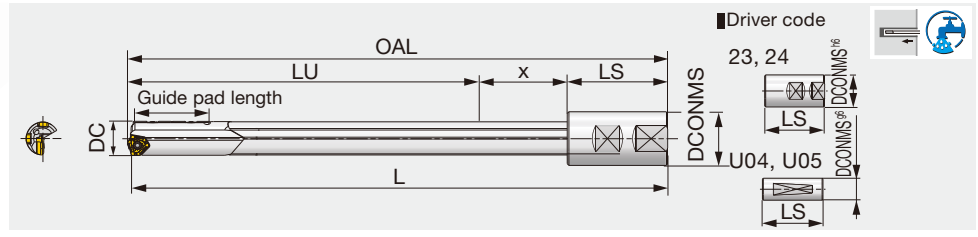

Inch	DC	L	DCONMS	LU	OAL	LS	X	Driver code	Insert	Guide pad	Guide pad length
TRLGCH14.68X1830-U05	0.578	72.047	1.250	68.504	72.126	2.756	0.866	U05	TOHT07...	GP05-060, GP05-18-060-DC	1.417
TRLGCH15.06X1830-U05	0.593	72.047	1.250	68.465	72.126	2.756	0.906	U05	TOHT07...	GP05-060, GP05-18-060-DC	1.417
TRLGCH18.24X1830-U05	0.718	72.047	1.250	68.346	72.165	2.756	1.063	U05	TOHT09...	GP06-085, GP06-20-085-DC	1.575
TRLGCH18.64X1830-U05	0.734	72.047	1.250	68.346	72.165	2.756	1.063	U05	TOHT09...	GP06-085, GP06-20-085-DC	1.575
TRLGCH23.42X1830-U05	0.922	72.047	1.250	68.087	72.181	2.756	1.339	U05	TOHT11...	GP06-100, GP06-20-100-DC	1.575
TRLGCH23.80X1830-U05	0.937	72.047	1.250	68.008	72.181	2.756	1.417	U05	TOHT11...	GP06-100, GP06-20-100-DC	1.575

Metric	DC	L	DCONMS	LU	OAL	LS	X	Driver code	Insert	Guide pad	Guide pad length
TRLGCH14.68X1830-U05	14.68	1830	31.75	1740	1832	70	22	U05	TOHT07...	GP05-060, GP05-18-060-DC	36
TRLGCH15.00X1650-U04	15	1650	25.4	1559	1652	70	23	U04	TOHT07...	GP05-060, GP05-18-060-DC	36
TRLGCH15.00X1650-23	15	1650	25	1573	1652	56	23	23	TOHT07...	GP05-060, GP05-18-060-DC	36
TRLGCH15.06X1830-U05	15.06	1830	31.75	1739	1832	70	23	U05	TOHT07...	GP05-060, GP05-18-060-DC	36
TRLGCH18.00X1650-U04A	18	1650	25.4	1555.2	1652.2	70	27	U04	TOHT08...	GP05-075, GP05-18-075-DC	36
TRLGCH18.00X1650-23A	18	1650	25	1569.2	1652.2	56	27	23	TOHT08...	GP05-075, GP05-18-075-DC	36
TRLGCH18.24X1830-U05	18.24	1830	31.75	1736	1833	70	27	U05	TOHT09...	GP06-085, GP06-20-085-DC	40
TRLGCH18.64X1830-U05	18.64	1830	31.75	1736	1833	70	27	U05	TOHT09...	GP06-085, GP06-20-085-DC	40
TRLGCH23.00X1650-U05	23	1650	31.75	1549.4	1653.4	70	34	U05	TOHT11...	GP06-100, GP06-20-100-DC	40
TRLGCH23.00X1650-24	23	1650	32	1559.4	1653.4	60	34	24	TOHT11...	GP06-100, GP06-20-100-DC	40
TRLGCH23.42X1830-U05	23.42	1830	31.75	1729.4	1833.4	70	34	U05	TOHT11...	GP06-100, GP06-20-100-DC	40
TRLGCH23.80X1830-U05	23.8	1830	31.75	1727.4	1833.4	70	36	U05	TOHT11...	GP06-100, GP06-20-100-DC	40
TRLGCH24.00X1650-U05	24	1650	31.75	1547.4	1653.4	70	36	U05	TOHT11...	GP06-100, GP06-20-100-DC	40
TRLGCH24.00X1650-24	24	1650	32	1557.4	1653.4	60	36	24	TOHT11...	GP06-100, GP06-20-100-DC	40

DC (in)	Tool diameter tolerance (in)	Applicable tolerance range of hole diameter (in)	DC (mm)	Tool diameter tolerance (mm)	Applicable tolerance range of hole diameter (mm)
ø0.578 - ø0.945	0 / - 0.004	+ 0.002 / - 0.005	14.68 - 24	0 / - 0.09	+ 0.05 / - 0.12

### SPARE PARTS

Designation	Insert		Guide pad	
	Screw	Wrench	Screw	Wrench
TRLGCH14... - TRLGCH18...	SR14-560/S	T-8F	SR34-508	T-7F
TRLGCH23... - TRLGCH24...	SR14-571/S	T-10/5	SR34-508	T-7F

Recommended clamping torque: SR34-508 = 0.66 lb-ft, R14-560/S = 0.89 lb-ft, SR14-571/S = 2.36 lb-ft

### Tool selection with regard to cross hole diameters and drill diameters

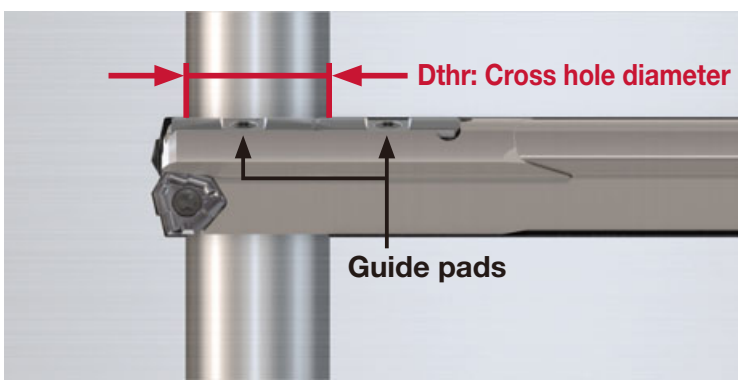
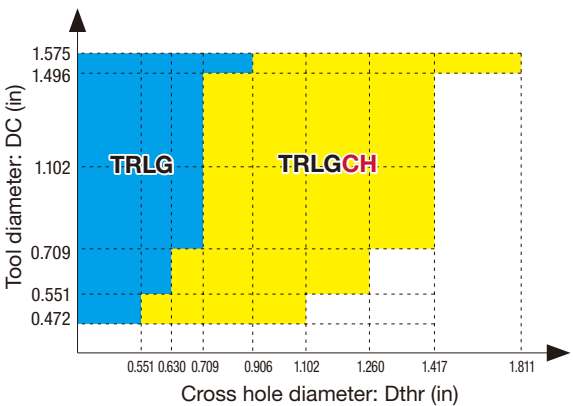

Note: A TRLG drill can be used when the cross hole diameter (Dthr) is smaller than the drill's guide pad length. When the cross hole diameter is larger than the drill's guide pad length, use an TRLGCH drill.

Reference pages: Inserts, Guide pads → J125 - J128, Standard cutting conditions → J130

### Indexable gun drill for gun drill machines

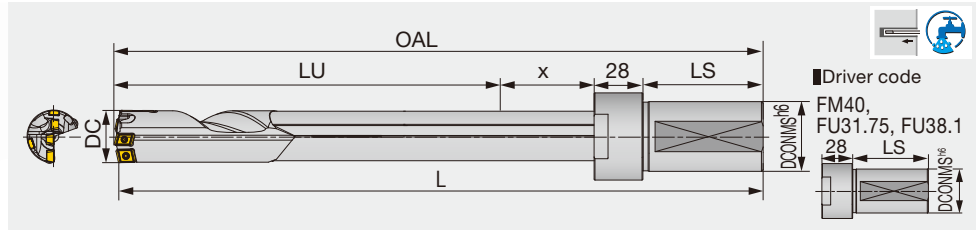

Inch		DC	L	DCONMS	LU	OAL	LS	x	Driver code	Insert	Guide pad
TRLG29.36X1828-FU31.75		1.156	71.969	1.250	66.520	72.071	27.165	1.732	FU31.75	FBM07**-C, FBM06**-I, FBH06**-P	GP06, GP06-20-120-DC
Metric		DC	L	DCONMS	LU	OAL	LS	x	Driver code	Insert	Guide pad
TRLG30.00X1000-FM40		30	1000	40	860.9	1002.9	69	45	FM40	FBM07**-C, FBM07**-I, FBH08**-P	GP06, GP06-20-120-DC
TRLG30.00X1650-FM40		30	1650	40	1510.9	1652.9	69	45	FM40	FBM07**-C, FBM07**-I, FBH08**-P	GP06, GP06-20-120-DC
TRLG30.00X1650-FU38.1		30	1650	38.1	1510.9	1652.9	69	45	FU38.1	FBM07**-C, FBM07**-I, FBH08**-P	GP06, GP06-20-120-DC

DC (in)	Tool diameter tolerance (in)	Applicable tolerance range of hole diameter (in)	DC (mm)	Tool diameter tolerance (mm)	Applicable tolerance range of hole diameter (mm)
1.156	0 / - 0.003	+ 0.002 / - 0.004	30	0 / - 0.07	+ 0.05 / - 0.1

Caution:  
The drill pipe is blackened to increase the resistance to corrosion, and the finished surface may appear uneven.  
This, however, will not affect the performance of the drill.

### SPARE PARTS



Designation	Insert						Guide pad	
	Central		Intermediate		Peripheral		Screw	Wrench
	Screw	Wrench	Screw	Wrench	Screw	Wrench		
TRLG29.36...	CSTB-2.5	T-8F	CSTB-2.2	T-7F	CSTB-2.2	T-7 F	SR34-508	T-7F
TRLG30...	CSTB-2.5	T-8F	CSTB-2.5	T-8F	CSTB-2.5	T-8F	SR34-508	T-7F

Recommended clamping torque: SR34-508 = 0.66 lb-ft, CSTB-2.5 = 0.96 lb-ft

**AVAILABLE RANGE OF TAILOR-MADE DRILL BODIES (FOR LATHES AND MACHINING CENTERS)  
MCTR, MCTRCH (FOR DRILLING CROSS HOLE APPLICATIONS)**

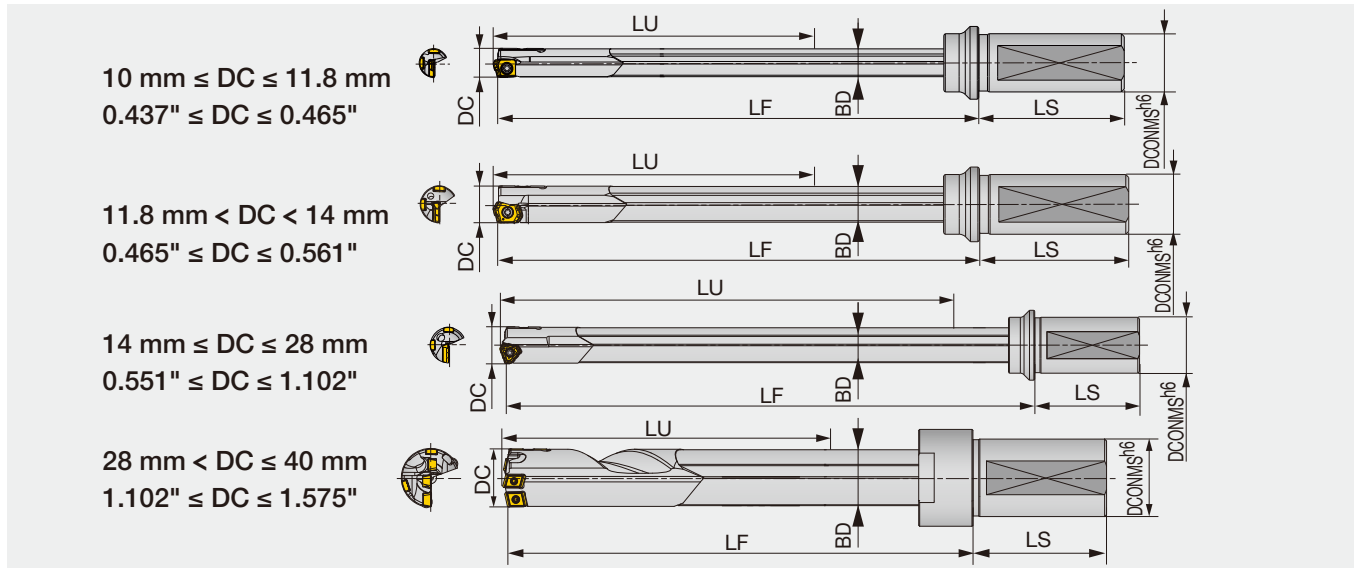

DC	DCONMS	LU	LS	LF	BD	DC	DCONMS	LU	LS	LF	BD
10 - 10.39	20	138 - 526	50	164 - 551	9.6	23.7 - 24.69	32	123 - 1253	60	171 - 1300	23
10.4 - 10.69	20	137 - 551	50	164 - 577	9.9	24.7 - 25.69	32	122 - 1303	60	171 - 1351	24
10.7 - 10.99	20	137 - 551	50	164 - 577	10.2	25.7 - 26.69	40	120 - 1353	70	171 - 1403	25
11 - 11.49	20	136 - 601	50	164 - 628	10.5	26.7 - 27.69	40	119 - 1403	70	171 - 1454	26
11.5 - 11.8	20	136 - 601	50	164 - 628	11	27.7 - 28	40	117 - 1403	70	171 - 1456	27
11.81 - 12.49	20	135 - 651	50	164 - 679	11.5	28.01 - 29	40	154 - 1452	69	222 - 1519	27
12.5 - 12.99	20	134 - 651	50	164 - 680	12	29.01 - 29.99	40	152 - 1502	69	222 - 1571	28
13 - 13.49	25	130 - 701	56	164 - 734	12.5	30 - 31	40	151 - 1552	69	222 - 1622	29
13.5 - 13.99	25	130 - 701	56	164 - 734	13	31.01 - 32	40	149 - 1602	69	222 - 1674	30
14 - 14.49	25	136 - 752	56	170 - 786	13.5	32.01 - 33	40	148 - 1653	69	222 - 1726	31
14.5 - 14.99	25	135 - 752	56	170 - 787	14	33.01 - 34	40	146 - 1702	69	222 - 1777	32
15 - 15.99	25	134 - 802	56	170 - 838	14.5	34.01 - 35	40	146 - 1753	69	222 - 1828	32
16 - 16.79	25	134 - 852	56	171 - 888	15.5	35.01 - 36	40	143 - 1803	69	222 - 1881	34
16.8 - 17.69	25	133 - 902	56	171 - 939	16.2	36.01 - 37	40	143 - 1852	69	222 - 1930	34
17.7 - 18.69	25	131 - 952	56	171 - 991	17.2	37.01 - 38	40	140 - 1903	69	222 - 1984	36
18.7 - 19.69	25	130 - 1003	56	170 - 1043	18.2	38.01 - 39	40	146 - 1953	69	227 - 2033	36
19.7 - 20.69	32	128 - 1053	60	170 - 1095	19	39.01 - 40	40	143 - 2003	69	227 - 2086	38
20.7 - 21.69	32	128 - 1103	60	171 - 1145	20						
21.7 - 22.69	32	126 - 1153	60	171 - 1197	21						
22.7 - 23.69	32	125 - 1203	60	171 - 1248	22						

(Unit: mm)

Please provide the driver shape necessary for your request

Grade  
Insert  
Ext. Toolholder  
Int. Toolholder  
Threading  
Grooving  
Miniature tool  
Milling cutter  
Endmill  
Drilling tool  
Tooling System  
User's Guide  
Index



**AVAILABLE RANGE OF TAILOR-MADE DRILL BODIES (FOR GUN DRILL MACHINES)  
 TRLG, TRLGCH (FOR DRILLING CROSS HOLE APPLICATIONS)**

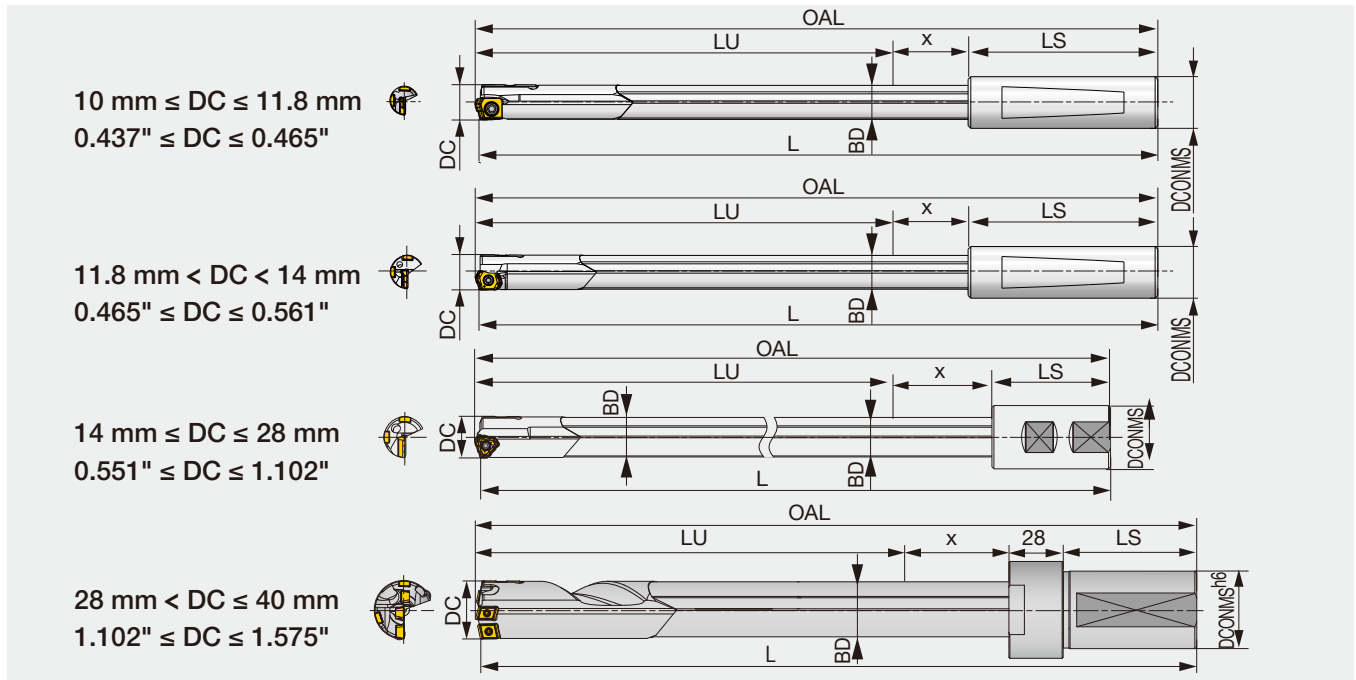

DC	L	x	BD	DC	L	x	BD
10 - 10.39	400 - 1650	15	9.6	23.7 - 24.69	400 - 2400	36	23
10.4 - 10.69	400 - 1650	16	9.9	24.7 - 25.69	400 - 2400	37	24
10.7 - 10.99	400 - 1650	16	10.2	25.7 - 26.69	400 - 2400	39	25
11 - 11.49	400 - 1650	17	10.5	26.7 - 27.69	400 - 2400	40	26
11.5 - 11.99	400 - 1650	17	11	27.7 - 28	400 - 2400	42	27
12 - 12.49	400 - 2400	18	11.5	28.01 - 29	400 - 2400	42	27
12.5 - 12.99	400 - 2400	19	12	29.01 - 29.99	400 - 2400	44	28
13 - 13.49	400 - 2400	20	12.5	30 - 31	400 - 2400	45	29
13.5 - 13.99	400 - 2400	20	13	31.01 - 32	400 - 2400	47	30
14 - 14.49	400 - 2400	21	13.5	32.01 - 33	400 - 2400	48	31
14.5 - 14.99	400 - 2400	22	14	33.01 - 34	400 - 2400	50	32
15 - 15.99	400 - 2400	23	14.5	34.01 - 35	400 - 2400	50	32
16 - 16.79	400 - 2400	24	15.5	35.01 - 36	400 - 2400	53	34
16.8 - 17.69	400 - 2400	25	16.2	36.01 - 37	400 - 2400	53	34
17.7 - 18.69	400 - 2400	27	17.2	37.01 - 38	400 - 2400	56	36
18.7 - 19.69	400 - 2400	28	18.2	38.01 - 39	400 - 2400	56	36
19.7 - 20.69	400 - 2400	30	19	39.01 - 40	400 - 2400	59	38
20.7 - 21.69	400 - 2400	31	20				
21.7 - 22.69	400 - 2400	33	21				
22.7 - 23.69	400 - 2400	34	22				

(Unit: mm)

Please provide the driver shape necessary for your request



# INSERT

## ZSGT-NDJ

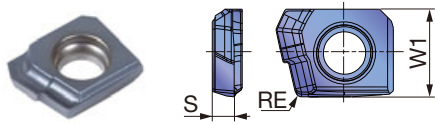

<b>P</b>	Steel	★					
<b>M</b>	Stainless	★					
<b>K</b>	Cast iron	★					
<b>N</b>	Non-ferrous	★					
<b>S</b>	Superalloys	★					
<b>H</b>	Hard materials	★					

★ : First choice  
☆ : Second choice

Designation	DCN (in)	DCX (in)	Coated		W1 (in)	S (in)	RE (in)
			AH9130				
ZSGT060204R-NDJ	0.394	0.465	●		0.236	0.059	0.016

● : Line up  
Package quantity = 10 pcs.

## LOGT-NDJ

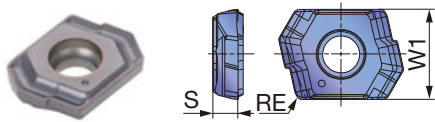

<b>P</b>	Steel	★	☆				
<b>M</b>	Stainless	★	☆				
<b>K</b>	Cast iron	★	☆				
<b>N</b>	Non-ferrous	★	☆				
<b>S</b>	Superalloys	★	☆				
<b>H</b>	Hard materials	★	☆				

★ : First choice  
☆ : Second choice

Designation	DCN (in)	DCX (in)	Coated		W1 (in)	S (in)	RE (in)
			AH9130	AH725			
LOGT060204R-NDJ	0.465	0.551	●	●	0.279	0.079	0.016

● : Line up  
Package quantity = 10 pcs.

## TOHT-NDJ (070..., 080...)

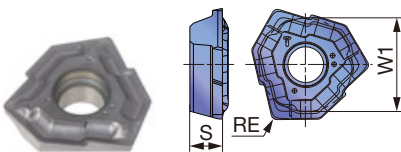

## TOHT-NDJ (090... - 120...)

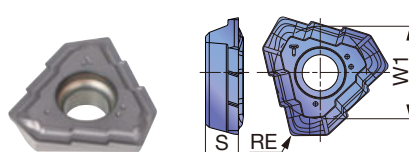

<b>P</b>	Steel	★	☆				
<b>M</b>	Stainless	★	☆				
<b>K</b>	Cast iron	★	☆				
<b>N</b>	Non-ferrous	★	☆				
<b>S</b>	Superalloys	★	☆				
<b>H</b>	Hard materials	★	☆				

★ : First choice  
☆ : Second choice

Designation	DCN (in)	DCX (in)	Coated		W1 (in)	S (in)	RE (in)
			AH9130	AH725			
TOHT070304R-NDJ	0.551	0.630	●	●	0.303	0.091	0.016
TOHT080305R-NDJ	0.630	0.709	●	●	0.337	0.11	0.020
TOHT090305R-NDJ	0.709	0.787	●	●	0.328	0.118	0.020
TOHT100305R-NDJ	0.788	0.866	●	●	0.363	0.130	0.020
TOHT110405R-NDJ	0.866	0.984	●	●	0.409	0.150	0.020
TOHT120405R-NDJ	0.985	1.102	●	●	0.456	0.169	0.020

● : Line up  
Package quantity = 10 pcs.

Grade  
Insert  
Ext. Toolholder  
Int. Toolholder  
Threading  
Grooving  
Miniature tool  
Milling cutter  
Endmill  
Drilling tool  
Tooling System  
User's Guide  
Index

A  
B  
C  
D  
E  
F  
G  
H  
I  
J  
K  
L  
M

**TOHT-NDL (07..., 08...)**

**TOHT-NDL (09... - 12...)**

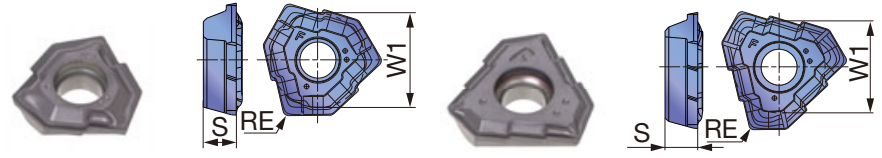

<b>P</b> Steel	★							
<b>M</b> Stainless	★							
<b>K</b> Cast iron	★							
<b>N</b> Non-ferrous	★							
<b>S</b> Superalloys	★							
<b>H</b> Hard materials	★							

★ : First choice  
 ☆ : Second choice

Designation	DCN (in)	DCX (in)	Coated						W1 (in)	S (in)	RE (in)
			AH725								
TOHT070304R-NDL	0.551	0.630	●						0.303	0.091	0.016
TOHT080305R-NDL	0.630	0.709	●						0.337	0.110	0.020
TOHT090305R-NDL	0.709	0.787	●						0.328	0.118	0.020
TOHT100305R-NDL	0.788	0.866	●						0.363	0.130	0.020
TOHT110405R-NDL	0.866	0.984	●						0.409	0.150	0.020
TOHT120405R-NDL	0.985	1.102	●						0.456	0.169	0.020

● : Line up  
 Package quantity = 10 pcs.

■ Identifications for NDL and NDJ geometries

Chipbreaker	NDL	NDJ
Cutting edge strength	Sharp	Strong
ID on insert		

■ Recommended feed rates

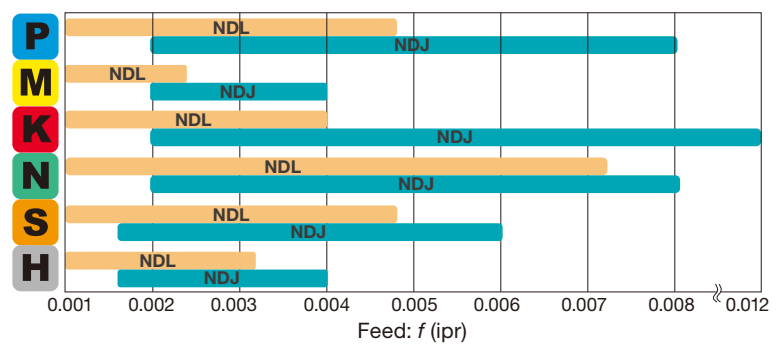

**FBM-C (For central)**

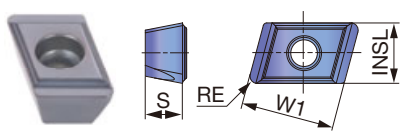

<b>P</b> Steel	★	☆	☆					
<b>M</b> Stainless	★	☆	☆					
<b>K</b> Cast iron	★	☆	☆					
<b>N</b> Non-ferrous	★	☆	☆					
<b>S</b> Superalloys	☆	☆	★					
<b>H</b> Hard materials	☆	☆	★					

★ : First choice  
 ☆ : Second choice

Designation	INSL (in)	W1 (in)	Coated			S (in)	DCN (in)	DCX (in)	RE (in)
			AH9130	AH725	AH8015				
FBM070408L-G-C	0.256	0.394	●	●	●	0.157	1.103	1.378	0.031
FBM080408L-G-C	0.315	0.394	●	●	●	0.157	1.378	1.575	0.031

● : Line up  
 Package quantity = 10 pcs.

### FBM-I (For intermediate)

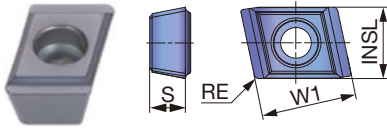

<b>P</b>	Steel	★	☆	☆
<b>M</b>	Stainless	★	☆	☆
<b>K</b>	Cast iron	★	☆	☆
<b>N</b>	Non-ferrous	★	☆	☆
<b>S</b>	Superalloys	☆	☆	★
<b>H</b>	Hard materials	☆	☆	★

★ : First choice  
☆ : Second choice

Designation	INSL (in)	W1 (in)	Coated				S (in)	DCN (in)	DCX (in)	RE (in)
			AH9130	AH725	AH8015					
FBM060304R-G-I	0.217	0.315	●	●	●	0.118	1.103	1.181	0.016	
FBM060304R-DL-I	0.217	0.315	●	●		0.118	1.103	1.181	0.016	
FBM070404R-G-I	0.256	0.394	●	●	●	0.157	1.181	1.575	0.016	
FBM070404R-DL-I	0.256	0.394	●	●		0.157	1.181	1.575	0.016	

● : Line up  
Package quantity = 10 pcs.

### FBH-P (For peripheral)

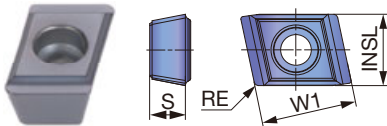

<b>P</b>	Steel	★	☆	☆	☆
<b>M</b>	Stainless	★	☆	☆	☆
<b>K</b>	Cast iron	★	☆	☆	☆
<b>N</b>	Non-ferrous	★	☆	☆	☆
<b>S</b>	Superalloys	☆	☆	★	☆
<b>H</b>	Hard materials	☆	☆	★	

★ : First choice  
☆ : Second choice

Designation	INSL (in)	W1 (in)	Coated				S (in)	DCN (in)	DCX (in)	RE (in)
			AH9130	AH725	AH8015	UC3120				
FBH060304R-G-P	0.236	0.315		●	▲	0.118	1.103	1.181	0.016	
FBH060308R-G-P	0.236	0.315	●	●	●	0.118	1.103	1.181	0.031	
FBH080404R-G-P	0.295	0.394	●	●	▲	0.157	1.181	1.496	0.016	
FBH080408R-G-P	0.295	0.394	●	●	●	0.157	1.181	1.496	0.031	
FBH090404R-G-P	0.354	0.394	●	●	▲	0.157	1.496	1.575	0.016	
FBH090408R-G-P	0.354	0.394	●	●	●	0.157	1.496	1.575	0.031	

● : Line up  
▲ : To be discontinued  
Package quantity = 10 pcs.

### Recommended feed rates

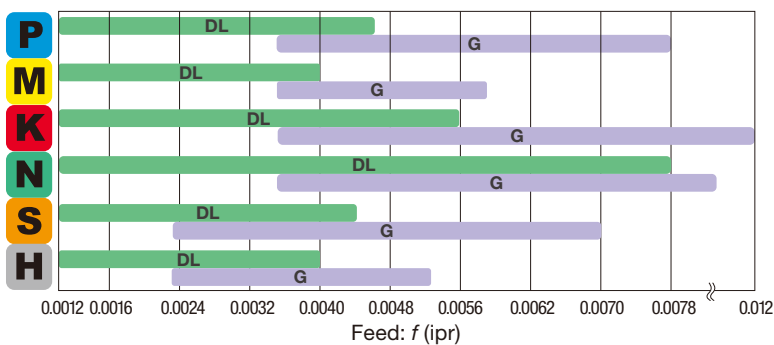

Note: For cross hole drilling, please use the DL type chipbreaker because the feed needs to be reduced.

# CARBIDE GUIDE PADS

GP04, 05, 06, 07, 08

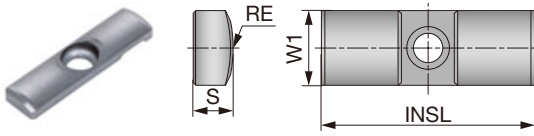

<b>P</b>	Steel	☆	★	☆
<b>M</b>	Stainless	☆	☆	★
<b>K</b>	Cast iron	☆	★	☆
<b>N</b>	Non-ferrous	☆	★	☆
<b>S</b>	Superalloys	☆	★	☆
<b>H</b>	Hard materials	☆	★	☆

★ : First choice  
☆ : Second choice

Designation	DCN (in)	DCX (in)	Coated			W1 (in)	INSL (in)	S (in)	RE (in)
			F1122	FH3125	FH3135				
GP04-16-045-DC	0.394	0.433	●			0.157	0.630	0.071	0.177
GP04-16-050-DC	0.433	0.472	●			0.157	0.630	0.071	0.197
GP04-055	0.472	0.551	●			0.157	0.630	0.079	0.217
GP04-16-055-DC	0.472	0.551	●	●		0.157	0.630	0.079	0.217
GP05-060	0.551	0.630	●			0.197	0.709	0.098	0.236
GP05-18-060-DC	0.551	0.630	●	●		0.197	0.709	0.098	0.236
GP05-075	0.630	0.709	●			0.197	0.709	0.098	0.295
GP05-18-075-DC	0.630	0.709	●	●		0.197	0.709	0.098	0.295
GP06-085	0.709	0.827	●			0.236	0.787	0.118	0.335
GP06-20-085-DC	0.709	0.827	●	●		0.236	0.787	0.118	0.335
GP06-100	0.827	0.984	●			0.236	0.787	0.118	0.394
GP06-20-100-DC	0.827	0.984	●	●		0.236	0.787	0.118	0.394
GP06	0.985	1.299	●			0.236	0.787	0.118	0.472
GP06-20-120-DC	0.985	1.299	●	●		0.236	0.787	0.118	0.472
GP07	1.300	1.496	●			0.276	0.787	0.138	0.472
GP07-20-120-DC	1.300	1.496	●	●		0.276	0.787	0.138	0.472
GP08	1.496	1.575	●			0.315	0.984	0.177	0.610
GP08-25-155-DC	1.496	1.575	●	●		0.315	0.984	0.177	0.610

● : Line up  
Package quantity = 5 pcs.

# SHIMS

## For fine adjustments of hole diameters

### SHIMSET-GP04

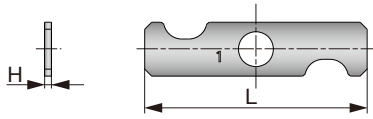

### SHIMSET-GP05

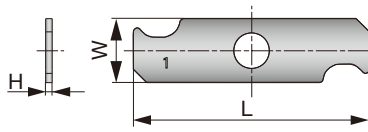

### SHIMSET-GP06

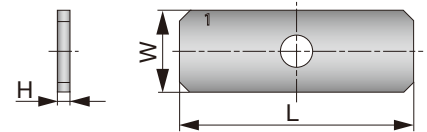

Designation	DC	W	L	H
SHIMSET-GP04	10 - 13.99	4	16	0.01 - 0.05
SHIMSET-GP05	14 - 18	5	18	0.01 - 0.05
SHIMSET-GP06	18.01 - 33	5	18	0.01 - 0.05

(Unit : mm)

- A shim set contains 5 shims in thicknesses of 0.01 mm, 0.02 mm, 0.03 mm, 0.04 mm, and 0.05 mm, respectively.  
 - Adjusting shims are sold by set only, not to be sold separately.

## Shim combinations for various diameters

Diameter adjustments	Shim(s) for measuring guide pad	Shim(s) for supporting guide pad	Number of shim sets needed
+0.0004	0.0004	-	1
+0.0008	0.0008	0.0004	1
+0.0012	0.0012	0.0004 + 0.0008	1
+0.0016	0.0016	0.0004 + 0.0012	1
+0.0020	0.0020	0.0008 + 0.0012	1
+0.0024	0.0004 + 0.0020	0.0008 + 0.0016	1
+0.0028	0.0008 + 0.0020	0.0012 + 0.0016	1
+0.0031	0.0012 + 0.0020	0.0016 + 0.0016	2
+0.0035	0.0016 + 0.0020	0.0016 + 0.0020	2
+0.0039	0.0020 + 0.0020	0.0016 + 0.0016 + 0.0008	2

(Unit: in)

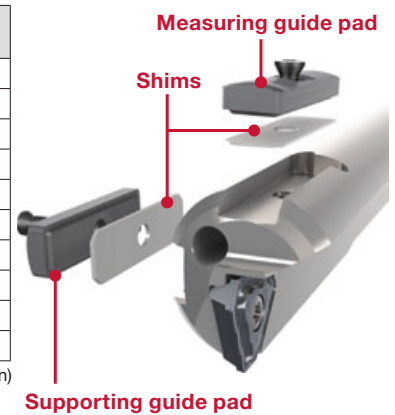

## How to install adjusting shims

1. Measure the drill diameter.



3. Remove the guide pads.



2. Select the shim sizes for adjustment.

Note: Consider that the hole diameter may expand during drilling for + $\phi$ 0.0007" to + $\phi$ 0.011" (+ $\phi$ 0.02 mm to + $\phi$ 0.03 mm).

<https://www.tungaloy.com/product/deeptri-drill/>



4. Place the shims underneath both guide pads.

5. Measure to make sure the required diameter is achieved.



6. Drill a test hole to ensure the required hole size is achieved.

Note: For higher drilling precision, drill a hole after Step 1 to confirm the size difference between the measured drill diameter and actual drilled hole diameter.

Grade  
Insert  
Ext. Toolholder  
Int. Toolholder  
Threading  
Grooving  
Miniature tool  
Milling cutter  
Endmill  
Drilling tool  
Tooling System  
User's Guide  
Index

A  
B  
C  
D  
E  
F  
G  
H  
I  
J  
K  
L  
M

# STANDARD CUTTING CONDITIONS

Drill diameter: DC =  $\phi 0.394'' - \phi 1.102''$  ( $\phi 10 - \phi 28$  mm)

ISO	Workpiece material	Hardness	Priority	Chip-breaker	Grade	Cutting speed Vc (sfm)	Feed: f (ipr)				
							$\phi 10 - \phi 11.8$	$\phi 11.81 - \phi 13.99$	$\phi 14 - \phi 18$	$\phi 18.01 - \phi 28$	
P	Low carbon steel (C < 0.3) 70, 1025, etc.	- 200 HB	Lower feed	NDL	AH725	164 - 328	-	-	0.0012 - 0.0039	0.0012 - 0.0039	
			First choice	NDJ	AH9130	262 - 459	0.002 - 0.0031	0.002 - 0.0039	0.0024 - 0.0047	0.0031 - 0.0063	
	Carbon steel (C > 0.3) 1045C, 1055, etc.	- 300 HB	Lower feed	NDL	AH725	164 - 328	-	-	0.0012 - 0.0039	0.0012 - 0.0047	
			First choice	NDJ	AH9130	262 - 459	0.002 - 0.0055	0.002 - 0.0063	0.0028 - 0.0071	0.0031 - 0.0079	
	Low alloy steel (C < 0.3) 5120, etc.	- 200 HB	Lower feed	NDL	AH725	164 - 328	-	-	0.0012 - 0.0047	0.0031 - 0.0039	
			First choice	NDJ	AH9130	262 - 459	0.002 - 0.0031	0.002 - 0.0039	0.0024 - 0.0047	0.0031 - 0.0063	
	Alloy steel (C > 0.3) 4140, etc.	- 300 HB	Lower feed	NDL	AH725	164 - 328	-	-	0.0012 - 0.0039	0.0012 - 0.0047	
			First choice	NDJ	AH9130	262 - 394	0.002 - 0.0055	0.002 - 0.0063	0.0028 - 0.0071	0.0031 - 0.0079	
M*	Stainless steel (Austenitic) 304, 316, etc.	- 200 HB	Lower feed	NDL	AH725	164 - 328	-	-	0.0012 - 0.0024	0.0012 - 0.0024	
			First choice	NDJ	AH9130	197 - 328	0.002 - 0.0031	0.002 - 0.0039	0.002 - 0.0039	0.002 - 0.0047	
	Stainless steel (Martensitic, Ferritic) 430, 416, etc.	- 200 HB	Lower feed	NDL	AH725	164 - 328	-	-	0.0012 - 0.0024	0.0012 - 0.0024	
			First choice	NDJ	AH9130	197 - 328	0.002 - 0.0031	0.002 - 0.0039	0.002 - 0.0039	0.002 - 0.0047	
	Stainless steel (Precipitation hardening) S17400, etc.	-	Lower feed	NDL	AH725	164 - 328	-	-	0.0012 - 0.0024	0.0012 - 0.0024	
			First choice	NDJ	AH9130	197 - 328	0.002 - 0.0031	0.002 - 0.0039	0.002 - 0.0039	0.002 - 0.0047	
K	Gray cast iron No.250B, etc.	150 - 250 HB	Lower feed	NDL	AH725	164 - 328	-	-	0.0012 - 0.0059	0.002 - 0.0071	
			First choice	NDJ	AH9130	262 - 459	0.002 - 0.0079	0.002 - 0.0098	0.002 - 0.0098	0.002 - 0.0118	
	Ductile cast iron 700, etc.	150 - 250 HB	Lower feed	NDL	AH725	164 - 328	-	-	0.0012 - 0.0059	0.002 - 0.0071	
			First choice	NDJ	AH9130	262 - 459	0.002 - 0.0079	0.002 - 0.0098	0.002 - 0.0098	0.002 - 0.0118	
N	Aluminum alloys	-	Lower feed	NDL	AH725	262 - 525	-	-	0.0012 - 0.0059	0.0012 - 0.0059	
			First choice	NDJ	AH9130	328 - 656	0.002 - 0.0071	0.002 - 0.0079	0.0031 - 0.0087	0.0039 - 0.0098	
S	Heat-resistant alloys Inconel 718, etc.	- 40 HRC	Lower feed	NDL	AH725	66 - 164	-	-	0.0012 - 0.0024	0.0012 - 0.0031	
			First choice	NDJ	AH9130	66 - 164	0.0016 - 0.0024	0.0016 - 0.0031	0.0016 - 0.0031	0.0016 - 0.0039	
H	Titanium alloys Ti-6Al-4V, etc.	- 40 HRC	Lower feed	NDL	AH725	98 - 197	-	-	0.0012 - 0.0039	0.0012 - 0.0047	
			First choice	NDJ	AH9130	98 - 197	0.0016 - 0.0039	0.002 - 0.0051	0.002 - 0.0051	0.002 - 0.0059	
H	Hardened steel	- 50 HRC	Lower feed	NDL	AH725	131 - 328	-	-	0.0012 - 0.0031	0.0012 - 0.0031	
			First choice	NDJ	AH9130	164 - 328	0.0016 - 0.0024	0.0016 - 0.0031	0.0016 - 0.0031	0.0016 - 0.0039	

The use of NDL chipbreakers is recommended for cross hole drilling with low feed conditions.

\*Coolant recommendations for drilling stainless steel:

- Oil coolant is first priority

- Water soluble coolant requires at least 20% oil concentration

Drill diameter: DC =  $\phi 1.106'' - \phi 1.575''$  ( $\phi 28.01 - \phi 40$  mm)

ISO	Workpiece material	Hardness	Priority	For central		For intermediate		For peripheral		Cutting speed Vc (sfm)	Feed f (ipr) $\phi 1.103'' - \phi 1.575''$
				Chip-breaker	Grade	Chip-breaker	Grade	Chip-breaker	Grade		
P	Low carbon steel (C < 0.3) 70, 1025, etc.	- 200 HB	Lower feed	G	AH725	DL	AH725	G	AH725	164 - 328	0.0012 - 0.0039
			First choice	G	AH725	G	AH725	G	AH725	262 - 459	0.0039 - 0.0098
	Carbon steel (C > 0.3) 1045C, 1055, etc.	- 300 HB	Lower feed	G	AH725	DL	AH725	G	AH725	164 - 328	0.0012 - 0.0047
			First choice	G	AH725	G	AH725	G	AH725	262 - 459	0.0039 - 0.0118
	Low alloy steel (C < 0.3) 5120, etc.	- 200 HB	Lower feed	G	AH725	DL	AH725	G	AH725	164 - 328	0.0012 - 0.0039
			First choice	G	AH725	G	AH725	G	AH725	262 - 459	0.0039 - 0.0098
	Alloy steel (C > 0.3) 4140, etc.	- 300 HB	Lower feed	G	AH725	DL	AH725	G	AH725	164 - 328	0.0012 - 0.0047
			First choice	G	AH725	G	AH725	G	AH725	262 - 394	0.0039 - 0.0118
M*	Stainless steel (Austenitic) 304, 316, etc.	- 200 HB	Lower feed	G	AH8015	DL	AH725	G	AH725	164 - 328	0.0012 - 0.0039
			First choice	G	AH8015	G	AH8015	G	AH8015	197 - 328	0.0039 - 0.0059
	Stainless steel (Martensitic, Ferritic) 430, 416, etc.	- 200 HB	Lower feed	G	AH8015	DL	AH725	G	AH725	164 - 328	0.0012 - 0.0039
			First choice	G	AH8015	G	AH8015	G	AH8015	197 - 328	0.0039 - 0.0059
	Stainless steel (Precipitation hardening) S17400, etc.	-	Lower feed	G	AH8015	DL	AH725	G	AH725	164 - 328	0.0012 - 0.0039
			First choice	G	AH8015	G	AH8015	G	AH8015	197 - 328	0.0039 - 0.0059
K	Gray cast iron No.250B, etc.	150 - 250 HB	Lower feed	G	AH725	DL	AH725	G	AH725	164 - 328	0.0012 - 0.0055
			First choice	G	AH725	G	AH725	G	AH725	262 - 459	0.0039 - 0.0138
	Ductile cast iron 700, etc.	150 - 250 HB	Lower feed	G	AH725	DL	AH725	G	AH725	164 - 328	0.0012 - 0.0055
			First choice	G	AH725	G	AH725	G	AH725	262 - 459	0.0039 - 0.0138
N	Aluminum alloys	-	Lower feed	G	AH725	DL	AH725	G	AH725	262 - 525	0.0012 - 0.0079
			First choice	G	AH725	G	AH725	G	AH725	328 - 656	0.0039 - 0.0118
S	Heat-resistant alloys Inconel 718, etc.	- 40 HRC	Lower feed	G	AH8015	DL	AH725	G	AH725	66 - 164	0.0012 - 0.0031
			First choice	G	AH8015	G	AH8015	G	AH8015	66 - 164	0.0024 - 0.0051
H	Titanium alloys Ti-6Al-4V, etc.	- 40 HRC	Lower feed	G	AH725	DL	AH725	G	AH725	98 - 197	0.0012 - 0.0039
			First choice	G	AH725	G	AH725	G	AH725	98 - 197	0.0039 - 0.0071
H	Hardened steel	- 50 HRC	Lower feed	G	AH8015	DL	AH725	G	AH725	131 - 328	0.0012 - 0.0039
			First choice	G	AH8015	G	AH8015	G	AH8015	164 - 328	0.0024 - 0.0051

The use of DL chipbreakers is recommended for cross hole drilling with low feed conditions.

\*Coolant recommendations for drilling stainless steel:

- Oil coolant is first priority

- Water soluble coolant requires at least 20% oil concentration



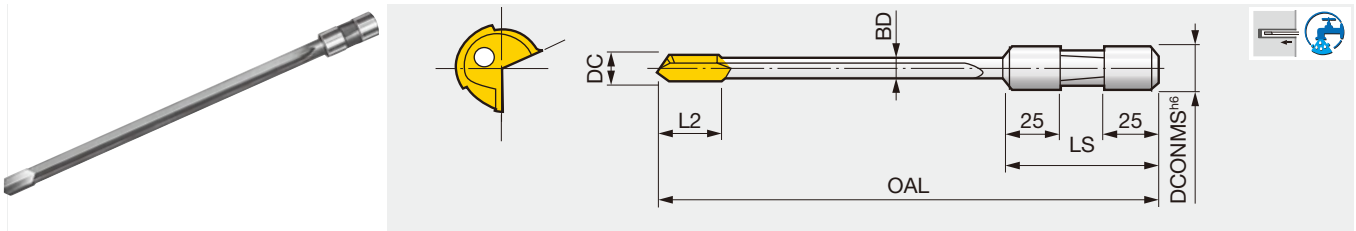

Metric	DC	DCONMS	L2	OAL
SLJ0300L0400NA	3	12.7	15	400
SLJ0300L0600NA	3	12.7	15	600
SLJ0500L0600NA	5	12.7	25	600
SLJ0550L0600NA	5.5	19.05	25	600
SLJ0600L0600NA	6	19.05	25	600
SLJ0700L0600NA	7	19.05	25	600
SLJ0800L0600NA	8	19.05	25	600
SLJ1000L0600NA	10	19.05	30	600
SLJ0500L1000NA	5	12.7	25	1000
SLJ0600L1000NA	6	19.05	25	1000
SLJ0700L1000NA	7	19.05	25	1000
SLJ0800L1000NA	8	19.05	25	1000
SLJ1000L1000NA	10	19.05	30	1000
SLJ0600L1250NA	6	19.05	25	1250
SLJ0610L1250NA	6.1	19.05	25	1250
SLJ0620L1250NA	6.2	19.05	25	1250
SLJ0700L1250NA	7	19.05	25	1250
SLJ0800L1250NA	8	19.05	25	1250
SLJ0810L1250NA	8.1	19.05	25	1250
SLJ0820L1250NA	8.2	19.05	25	1250
SLJ1000L1250NA	10	19.05	30	1250
SLJ1010L1250NA	10.1	19.05	30	1250
SLJ1020L1250NA	10.2	19.05	30	1250
SLJ1200L1250NA	12	19.05	30	1250
SLJ1210L1250NA	12.1	19.05	30	1250
SLJ1220L1250NA	12.2	19.05	30	1250
SLJ0600L1650NA	6	19.05	25	1650
SLJ0610L1650NA	6.1	19.05	25	1650
SLJ0620L1650NA	6.2	19.05	25	1650
SLJ0700L1650NA	7	19.05	25	1650
SLJ0800L1650NA	8	19.05	25	1650
SLJ0810L1650NA	8.1	19.05	25	1650
SLJ0820L1650NA	8.2	19.05	25	1650
SLJ1000L1650NA	10	19.05	30	1650
SLJ1010L1650NA	10.1	19.05	30	1650
SLJ1020L1650NA	10.2	19.05	30	1650
SLJ1200L1650NA	12	19.05	30	1650
SLJ1210L1650NA	12.1	19.05	30	1650
SLJ1220L1650NA	12.2	19.05	30	1650

## TUBE DIAMETER

DC	BD	DC	BD	DC	BD
3 - 3.19	2.9	5.2 - 5.49	5	8.7 - 9.19	8.5
3.2 - 3.39	3.1	5.5 - 5.79	5.3	9.2 - 9.69	9
3.4 - 3.59	3.3	5.8 - 5.99	5.6	9.7 - 10.39	9.5
3.6 - 3.89	3.5	6 - 6.19	5.8	10.4 - 10.89	10
3.9 - 4.09	3.7	6.2 - 6.59	5.9	10.9 - 11.39	10.6
4.1 - 4.29	3.9	6.6 - 7.09	6.4	11.4 - 11.99	11.1
4.3 - 4.49	4.1	7.1 - 7.59	6.9	12 - 12.2	11.7
4.5 - 4.89	4.3	7.6 - 8.09	7.4		
4.9 - 5.19	4.7	8.1 - 8.69	7.9		

## STANDARD CUTTING CONDITIONS







See more information

e-catalog





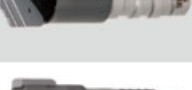
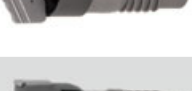
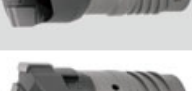
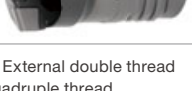

# Drill Head Category



Series	Designation	Shape	Drill diameter	Coolant supply	IT class	Surface finish Ra (μm)*3	Thread type			
							External single thread	External double thread	External quadruple thread	Internal single thread
<b>TRI-FINE</b>	<b>FNTR</b>		ø16 - ø28 (ø0.630" - ø1.102")	Internal	IT10	2	-	-	○	○
<b>FINE-BEAM</b>	<b>FNBN</b>		ø25 - ø89 (ø0.984" - ø3.504")	Internal	IT10	2	-	-	○	○
<b>UNIDEX</b>	<b>KUSTS</b>		ø38 - ø293.99 (ø1.496" - ø11.574")	Internal	IT10	3	-	-	○	○
<b>TRI-FINE</b>	<b>FNTR-D</b>		ø18.4 - ø28 (ø0.724" - ø1.102")	Internal	IT10	2	-	-	○	-
<b>FINE-BEAM</b>	<b>FNBR-D</b>		ø25 - ø65 (ø0.984" - ø2.559")	Internal	IT10	2	-	-	○	-
<b>UNIDEX</b>	<b>KUDTS</b>		ø38 - ø183.99 (ø1.496" - ø7.244")	Internal	IT10	3	-	-	○	-
Brazed	<b>MBU</b>		ø8 - ø14.79 (ø0.315" - ø0.582")	Internal	IT9	2	○	-	-	-
	<b>UTE</b>		ø12.6 - ø20 (ø0.496" - ø0.787")	Internal	IT9	2	-	○ <sup>*1</sup>	○ <sup>*2</sup>	-
	<b>BTU</b>		ø12.6 - ø65 (ø0.496" - ø0.614")	Internal	IT9	2	-	○ <sup>*1</sup>	○ <sup>*2</sup>	-
	<b>ETU</b>		ø18.4 - ø (ø0.724" - ø2.559")	Internal	IT9	2	-	-	○	-

\*1: UTE & BTU Drill head : ø12.6 mm - ø15.59 mm, External double thread  
 \*2: UTE & BTU Drill head : ø15.6 mm -, External quadruple thread  
 \*3: Just for reference

★ : First choice  
☆ : Second choice

Tube system	Machine				Workpiece material						Note	Page
	Deep hole drilling machines	Lathes	Vertical machining centers	Horizontal machining centers	P	M	K	N	S	H		
 (Single Tube System)	○	-	-	-	★	★	★	★	★	★	Indexable	J134 -
	○	-	-	-	★	★	★	★	★	★	Indexable	J139 -
	○	-	-	-	★	★	★	★	★	★	Indexable	J147 -
 (Double Tube System)	○	○	○	○	★	★	★	★	★	★	Indexable	J136
	○	○	○	○	★	★	★	★	★	★	Indexable	J141
	○	○	○	○	★	★	★	★	★	★	Indexable	J159 -
 (Single Tube System)	○	-	-	-	★	★	★	★	☆	☆	Brazed	J168
	○	-	-	-	★	★	★	★	☆	☆	Brazed	J169
	○	-	-	-	★	★	★	★	☆	☆	Brazed	J170 -
 (Double Tube System)	○	○	○	○	★	★	★	★	☆	☆	Brazed	J173

Grade	A
Insert	B
Ext. Toolholder	C
Int. Toolholder	D
Threading	E
Grooving	F
Miniature tool	G
Milling cutter	H
Endmill	I
Drilling tool	J
Tooling System	K
User's Guide	L
Index	M

Indexable head with external 4-start thread for single tube system (STS)

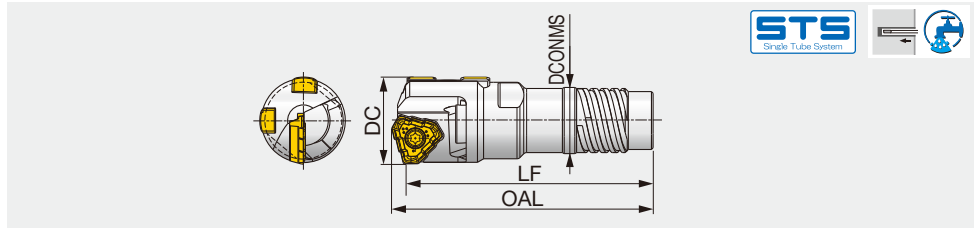

### Standard products

Metric	DC		Drill tube		OAL	LF	DCONMS	Insert	Guide pad
	(in)	(mm)	Designation	Dia. (mm)					
FNTR-0097S-16.00	0.630	16	ST0097	14	58	55	12.6	TOHT08...	GP06-075, GP06-20-075-DC
FNTR-0000S-20.00	0.787	20	ST0000	17	59	56	15.5	TOHT09...	GP06-085, GP06-20-085-DC
FNTR-00S-21.00	0.827	21	ST00	18	62	60	16	TOHT10...	GP06-085, GP06-20-085-DC
FNTR-01S-24.00	0.945	24	ST01	20	69	65.5	18	TOHT11...	GP06-100, GP06-20-100-DC
FNTR-02S-25.00	0.984	25	ST02	22	69	65.5	19.5	TOHT11...	GP06-100, GP06-20-100-DC
FNTR-02S-25.40	1.000	25.4	ST02	22	69	65.5	19.5	TOHT12...	GP06, GP06-20-120-DC

### Non-standard products (to be supplied on request)

When ordering

**FNTR-\*\*S - XX.XX**

Drill head - Diameter (mm)

e.g. Designation for tool diameter  $\varnothing$ 16.5 mm: **FNTR-0097S-16.50**

Metric	DCN		DCX		Drill tube		OAL	LF	DCONMS	Insert	Guide pad
	(in)	(mm)	(in)	(mm)	Designation	Dia. (mm)					
FNTR-0097S-xx.xx	0.630	16	0.657	16.7	ST0097	14	57	55	12.6	TOHT08...	GP06-075, GP06-20-075-DC
FNTR-0098S-xx.xx	0.658	16.71	0.697	17.7	ST0098	15	57	55	13.6	TOHT08...	GP06-075, GP06-20-075-DC
FNTR-0099S-xx.xx	0.697	17.71	0.709	18	ST0099	16	59	56	14.5	TOHT09...	GP06-075, GP06-20-075-DC
FNTR-0099S-xx.xx	0.709	18.01	0.744	18.9	ST0099	16	59	56	14.5	TOHT09...	GP06-085, GP06-20-085-DC
FNTR-0000S-xx.xx	0.744	18.91	0.787	20	ST0000	17	59	56	15.5	TOHT09...	GP06-085, GP06-20-085-DC
FNTR-00S-xx.xx	0.788	20.01	0.858	21.8	ST00	18	63	60	16	TOHT10...	GP06-085, GP06-20-085-DC
FNTR-01S-xx.xx	0.859	21.81	0.949	24.1	ST01	20	69	65.5	18	TOHT11...	GP06-100, GP06-20-100-DC
FNTR-02S-xx.xx	0.949	24.11	1.039	26.4	ST02	22	69	65.5	19.5	TOHT11...	GP06-100, GP06-20-100-DC
FNTR-03S-xx.xx	1.040	26.41	1.102	28	ST03	24	69	65.5	21	TOHT12...	GP06, GP06-20-120-DC

#### INSERT SPARE PARTS

Designation	Screw	Wrench
TOHT08...	CSTB-2.5S	T-8F
TOHT09...	CSTB-2.5S	T-8F
TOHT10...	CSTB-3S	T-9F
TOHT11...	CSTB-3.5H	T-15F
TOHT12...	CSTB-4S	T-15F

#### GUIDE PAD SPARE PARTS

Designation	Screw	Wrench
GP06-075	CSTB-2.2S	T-7F
GP06-085, GP06-20-085-DC	CSTB-2.2S	T-7F
GP06-100, GP06-20-100-DC	CSTB-2.2S	T-7F
GP06, GP06-20-120-DC	CSTB-2.2S	T-7F

Recommended clamping torque: CSTB-2.2S = 1 N·m, CSTB-2.5S/CSTB-3S = 2.3 N·m, CSTB-3.5H/CSTB-4S = 3 N·m

### STANDARD CUTTING CONDITIONS

See more information

e-catalog



Reference pages: Inserts, Guide pads → **J137 - J138**, Drill tube (STS) → **J174**

## TRI-FINE STS-IN

Indexable head with internal single-start thread for single tube system (STS)

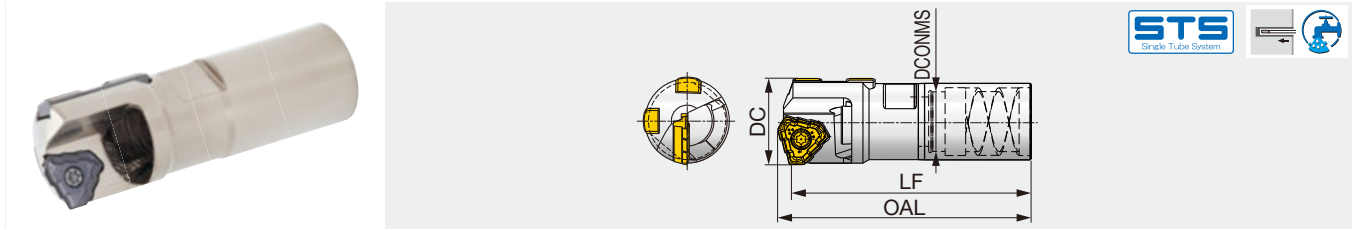

**Non-standard products (to be supplied on request)**

When ordering

**FNTR-\*\*\*N (-\*) - XX.XX**

Drill head

Diameter (mm)

e.g. Designation for tool diameter  $\varnothing$ 16.5 mm: **FNTR-13N-2-16.50**

Metric	DCN		DCX		Drill tube		OAL	LF	DCONMS	Insert	Guide pad
	(in)	(mm)	(in)	(mm)	Designation	Dia. (mm)					
FNTR-13N-2-xx.xx	0.630	16	0.650	16.5	UB13-1	13	55.5	53.5	10.8	TOHT08...	GP06-075, GP06-20-075-DC
FNTR-14N-1-xx.xx	0.650	16.51	0.679	17.25	UB14-1	14	55.5	53.5	12.1	TOHT08...	GP06-075, GP06-20-075-DC
FNTR-14N-2-xx.xx	0.680	17.26	0.709	18	UB14-2	14	55.5	53.5	12.1	TOHT08...	GP06-075, GP06-20-075-DC
FNTR-15N-xx.xx	0.709	18.01	0.748	19	UB15	15	57	54	12.8	TOHT09...	GP06-085, GP06-20-085-DC
FNTR-16.5N-xx.xx	0.748	19.01	0.787	19.99	UB16.5	16.5	57	54	13.8	TOHT09...	GP06-085, GP06-20-085-DC
FNTR-18N-xx.xx	0.787	20	0.866	21.99	UB18	18	61	58	14.5	TOHT09...	GP06-085, GP06-20-085-DC
FNTR-20N-xx.xx	0.866	22	0.984	24.99	UB20	20	63.5	60	16	TOHT11...	GP06-100, GP06-20-100-DC
FNTR-22N-xx.xx	0.984	25	1.023	25.99	UB22	22	63.5	60	17	TOHT11...	GP06-100, GP06-20-100-DC
FNTR-22N-xx.xx	1.024	26	1.063	26.99	UB22	22	68.5	65	17	TOHT12...	GP06, GP06-20-120-DC
FNTR-24N-xx.xx	1.063	27	1.102	28	UB24	24	68.5	65	19	TOHT12...	GP06, GP06-20-120-DC

### INSERT SPARE PARTS

Designation	Screw	Wrench
TOHT08...	CSTB-2.5S	T-8F
TOHT09...	CSTB-2.5S	T-8F
TOHT10...	CSTB-3S	T-9F
TOHT11...	CSTB-3.5H	T-15F
TOHT12...	CSTB-4S	T-15F

### GUIDE PAD SPARE PARTS

Designation	Screw	Wrench
GP06-075	CSTB-2.2S	T-7F
GP06-085, GP06-20-085-DC	CSTB-2.2S	T-7F
GP06-100, GP06-20-100-DC	CSTB-2.2S	T-7F
GP06, GP06-20-120-DC	CSTB-2.2S	T-7F

Recommended clamping torque: CSTB-2.2S = 1 N·m, CSTB-2.5S/CSTB-3S = 2.3 N·m, CSTB-3.5H/CSTB-4S = 3 N·m

## STANDARD CUTTING CONDITIONS

See more information

e-catalog



Reference pages: Inserts, Guide pads → **J137 - J138**, Drill tube (STS) → **J176**



# TRI-FINE DTS

## TRI-FINE DTS-EX

Indexable head with external 4-start thread for double tube system (DTS)

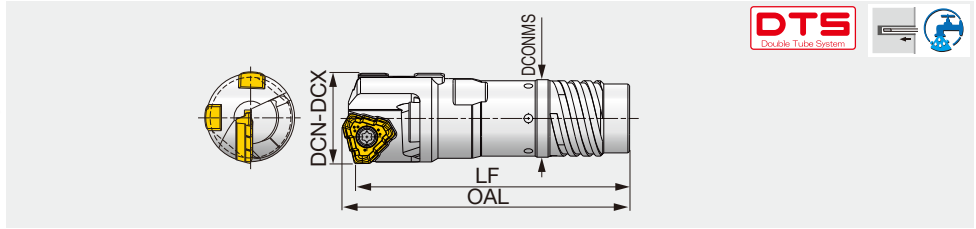

**Non-standard products (to be supplied on request)**

When ordering

**FNTR-\*\*D - XX.XX**

Drill head

Diameter (mm)

e.g. Designation for tool diameter  $\varnothing 20$  mm: FNTR-00D-20.00

Metric	DCN		DCX		Outer tube		OAL	LF	DCONMS	Insert	Guide pad
	(in)	(mm)	(in)	(mm)	Designation	Dia. (mm)					
FNTR-00D-xx.xx	0.724	18.4	0.787	20	OT00	18	62	59	16	TOHT09...	GP06-085, GP06-20-085-DC
FNTR-01D-xx.xx	0.788	20.01	0.827	21	OT01	19.5	66.5	63.5	18	TOHT10...	GP06-085, GP06-20-085-DC
FNTR-01D-xx.xx	0.827	21.01	0.858	21.8	OT01	19.5	66.5	63.5	18	TOHT10...	GP06-100, GP06-20-100-DC
FNTR-02D-xx.xx	0.859	21.81	0.866	21.99	OT02	21.5	66.5	63.5	19.5	TOHT10...	GP06-100, GP06-20-100-DC
FNTR-02D-xx.xx	0.866	22	0.949	24.1	OT02	21.5	69	65.5	19.5	TOHT11...	GP06-100, GP06-20-100-DC
FNTR-03D-xx.xx	0.949	24.11	0.984	25	OT03	23.5	69	65.5	21	TOHT11...	GP06-100, GP06-20-100-DC
FNTR-03D-xx.xx	0.985	25.01	1.039	26.4	OT03	23.5	71	67.5	21	TOHT12...	GP06, GP06-20-120-DC
FNTR-04D-xx.xx	1.040	26.41	1.102	28	OT04	26	74	70.5	23.5	TOHT12...	GP06, GP06-20-120-DC

### INSERT SPARE PARTS

Designation	Screw	Wrench
TOHT08...	CSTB-2.5S	T-8F
TOHT09...	CSTB-2.5S	T-8F
TOHT10...	CSTB-3S	T-9F
TOHT11...	CSTB-3.5H	T-15F
TOHT12...	CSTB-4S	T-15F

### GUIDE PAD SPARE PARTS

Designation	Screw	Wrench
GP06-075	CSTB-2.2S	T-7F
GP06-085, GP06-20-085-DC	CSTB-2.2S	T-7F
GP06-100, GP06-20-100-DC	CSTB-2.2S	T-7F
GP06, GP06-20-120-DC	CSTB-2.2S	T-7F

Recommended clamping torque: CSTB-2.2S = 1 N-m, CSTB-2.5S = 1.3 N-m, CSTB-3S = 2.3 N-m, CSTB-3.5H/CSTB-4S = 3 N-m

## STANDARD CUTTING CONDITIONS

See more information

e-catalog



Reference pages: Inserts, Guide pads → **J137 - J138**, Drill tube (DTS) → **J178**



## INSERT

### TOHT-NDJ (08...)

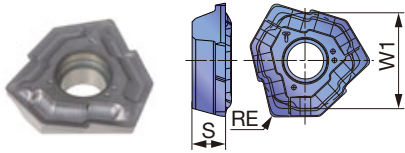

### TOHT-NDJ (09... - 12...)

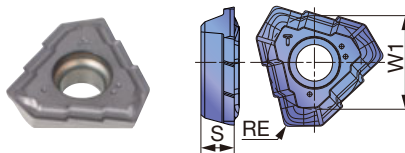

### TOHT-NDL (08...)

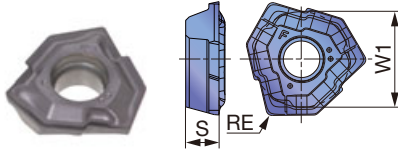

### TOHT-NDL (09... - 12...)

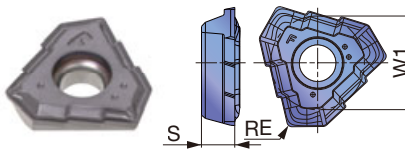

<b>P</b> Steel	★ ☆								
<b>M</b> Stainless	★ ☆								
<b>K</b> Cast iron	★ ☆								
<b>N</b> Non-ferrous	★ ☆								
<b>S</b> Superalloys	☆ ☆								
<b>H</b> Hard materials	☆ ☆								

★ : First choice  
☆ : Second choice

Designation	DCN (in)	DCX (in)	Coated							W1 (in)	S (in)	RE (in)
			AH9130	AH725								
TOHT080305R-NDJ	0.630	0.709	●	●						0.337	0.110	0.020
TOHT090305R-NDJ	0.709	0.787	●	●						0.328	0.118	0.020
TOHT100305R-NDJ	0.788	0.866	●	●						0.363	0.130	0.020
TOHT110405R-NDJ	0.866	0.984	●	●						0.409	0.150	0.020
TOHT120405R-NDJ	0.985	1.102	●	●						0.456	0.169	0.020
TOHT080305R-NDL	0.630	0.709		●						0.337	0.110	0.020
TOHT090305R-NDL	0.709	0.787		●						0.328	0.118	0.020
TOHT100305R-NDL	0.788	0.866		●						0.363	0.130	0.020
TOHT110405R-NDL	0.866	0.984		●						0.409	0.150	0.020
TOHT120405R-NDL	0.985	1.102		●						0.456	0.169	0.020

● : Line up  
Package quantity = 10 pcs.

### Identifications for NDL and NDJ geometries

Chipbreaker	NDL	NDJ
Cutting edge strength	Sharp	Strong
ID on insert		

### Recommended feed rates

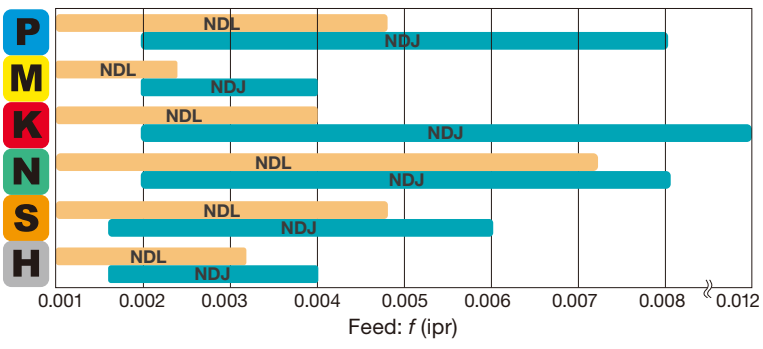

## GUIDE PAD

### GP06

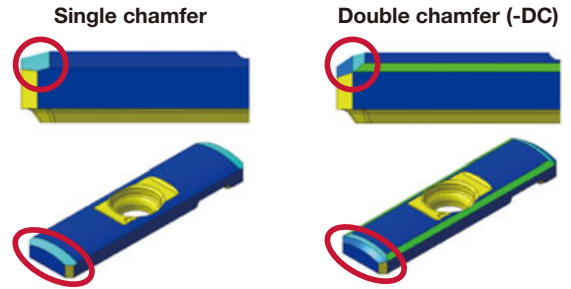
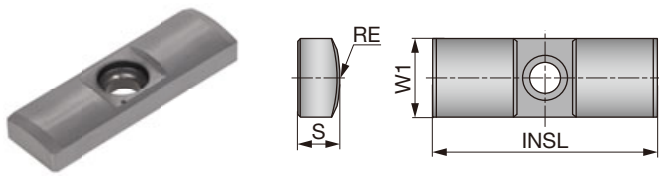

Designation	DCN (in)	DCX (in)	Coated			W1 (in)	INSL (in)	S (in)	RE (in)	Chamfer
			F1122	FH3125	FH3135					
GP06-075	0.630	0.709	●			0.236	0.787	0.118	0.295	Single
GP06-20-075-DC	0.630	0.709		●		0.236	0.787	0.118	0.295	Double
GP06-085	0.709	0.827	●			0.236	0.787	0.118	0.335	Single
GP06-20-085-DC	0.709	0.827		●	●	0.236	0.787	0.118	0.335	Double
GP06-100	0.827	0.984	●			0.236	0.787	0.118	0.394	Single
GP06-20-100-DC	0.827	0.984		●	●	0.236	0.787	0.118	0.394	Double
GP06	0.985	1.181	●			0.236	0.787	0.118	0.472	Single
GP06-20-120-DC	0.985	1.181		●	●	0.236	0.787	0.118	0.472	Double

●: Line up  
 Package quantity = 5 pcs.

### Grade recommendations

ISO	Oil coolant			Water based coolant		
	First choice	Second choice	Third choice	First choice	Second choice	Third choice
<b>P</b>	FH3125	F1122	FH3135	FH3135	FH3125	-
<b>M</b>	FH3135	FH3125	F1122	FH3135	FH3125	-
<b>K</b>	FH3125	F1122	FH3135	FH3135	FH3125	-
<b>N</b>	FH3125	F1122	FH3135	FH3135	FH3125	-
<b>S</b>	FH3135	FH3125	F1122	FH3135	FH3125	-
<b>H</b>	FH3135	FH3125	F1122	FH3135	FH3125	-

# FINE-BEAM STS

## FINE-BEAM STS-EX

Indexable head with external 4-start thread for single tube system (STS)  
 tool diameter:  $\varnothing 25 - \varnothing 65$  mm (0.984" - 2.559")

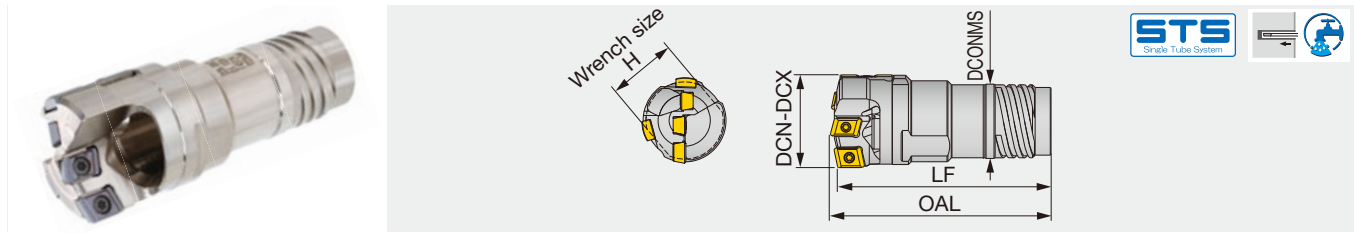

### Standard products

Metric	DC (in)	DC (mm)	Drill tube		Drill head			
			Designation	Dia. (mm)	OAL	LF	DCONMS	H
FNBM-02S-25.00	0.984	25	ST02	22	73	70	19.5	22
FNBM-02S-25.40	1.000	25.4	ST02	22	73	70	19.5	22
FNBM-03S-28.00	1.102	28	ST03	24	73	70	21	23
FNBM-04S-29.00	1.142	29	ST04	26	78	75	23.5	24
FNBM-04S-30.00	1.181	30	ST04	26	78	75	23.5	24
FNBM-05S-31.75	1.250	31.75	ST05	28	78	75	25.5	27
FNBM-05S-32.00	1.260	32	ST05	28	78	75	25.5	27
FNBM-05S-33.00	1.299	33	ST05	28	78	75	25.5	27
FNBM-06S-35.00	1.378	35	ST06	30	83	80	28	29
FNBM-06S-36.00	1.417	36	ST06	30	83	80	28	29
FNBM-07S-37.00	1.457	37	ST07	33	93	90	30	32
FNBM-07S-38.00	1.496	38	ST07	33	93	90	30	32
FNBM-07S-38.10	1.500	38.1	ST07	33	93	90	30	32
FNBM-08S-40.00	1.575	40	ST08	36	99	95	33	35
FNBM-09S-45.00	1.772	45	ST09	39	104	100	36	38
FNBM-10S-50.00	1.969	50	ST10	43	104	100	39	41
FNBM-11S-55.00	2.165	55	ST11	47	114	110	43	46
FNBM-12S-57.15	2.250	57.15	ST12	51	120	115	47	50
FNBM-12S-60.00	2.362	60	ST12	51	120	115	47	50
FNBM-13S-65.00	2.559	65	ST13	56	120	115	51	55

### Non-standard products (to be supplied on request)

When ordering

**FNBM-\*\*S - XX.XX**

Drill head      Diameter (mm)

e.g. Designation for tool diameter  $\varnothing 30.5$  mm: **FNBM-04S-30.50**

Metric	DCN		DCX		Drill tube			Drill head		
	(in)	(mm)	(in)	(mm)	Designation	Dia. (mm)	OAL	LF	DCONMS	H
FNBM-02S-xx.xx	0.984	25	1.039	26.4	ST02	22	73	70	19.5	22
FNBM-03S-xx.xx	1.040	26.41	1.130	28.7	ST03	24	73	70	21	23
FNBM-04S-xx.xx	1.130	28.71	1.220	31	ST04	26	78	75	23.5	24
FNBM-05S-xx.xx	1.221	31.01	1.311	33.3	ST05	28	78	75	25.5	27
FNBM-06S-xx.xx	1.311	33.31	1.425	36.2	ST06	30	83	80	28	29
FNBM-07S-xx.xx	1.426	36.21	1.559	39.6	ST07	33	93	90	30	32
FNBM-08S-xx.xx	1.559	39.61	1.693	43	ST08	36	99	95	33	35
FNBM-09S-xx.xx	1.693	43.01	1.850	47	ST09	39	104	100	36	38
FNBM-10S-xx.xx	1.851	47.01	2.035	51.7	ST10	43	104	100	39	41
FNBM-11S-xx.xx	2.036	51.71	2.213	56.2	ST11	47	114	110	43	46
FNBM-12S-xx.xx	2.213	56.21	2.386	60.6	ST12	51	120	115	47	50
FNBM-13S-xx.xx	2.386	60.61	2.559	65	ST13	56	120	115	51	55

### STANDARD CUTTING CONDITIONS

See more information

e-catalog



Reference pages: Spare parts → **J142**, Inserts → **J144 - J145**, Guide pads → **J146**, Drill tube (STS) → **J174**

# FINE-BEAM STS

## FINE-BEAM STS-IN

Indexable head with internal single-start thread for single tube system (STS)  
 tool diameter:  $\varnothing 25 - \varnothing 89$  mm (0.984" - 3.504")

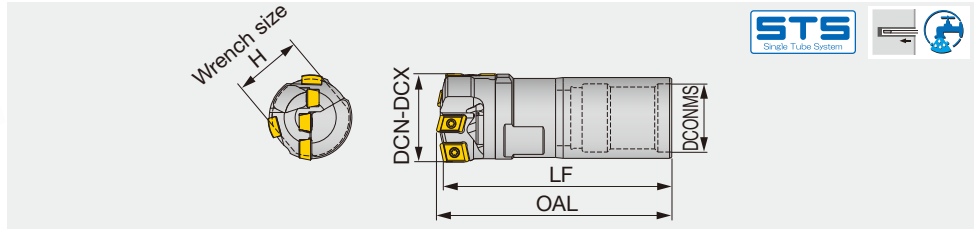

### Standard products

Metric	DC		Drill tube		Drill head			
	(in)	(mm)	Designation	Dia. (mm)	OAL	LF	DCONMS	H
FNBM-22N-25.00	0.984	25	UB22	22	73	70	20	19
FNBM-26N-30.00	1.181	30	UB26	26	78	75	24	24
FNBM-28N-32.00	1.260	32	UB28	28	78	75	26	26
FNBM-30N-35.00	1.378	35	UB30	30	93	90	27	28
FNBM-36N-40.00	1.575	40	UB36	36	104	100	33	32

### Non-standard products (to be supplied on request)

When ordering

**FNBM-\*\*N - XX.XX**

Drill head

Diameter (mm)

e.g. Designation for tool diameter  $\varnothing 30.5$  mm: **FNBM-26N-30.50**

Metric	DCN		DCX		Drill tube		Drill head			
	(in)	(mm)	(in)	(mm)	Designation	Dia. (mm)	OAL	LF	DCONMS	H
FNBM-22N-xx.xx	0.984	25	1.063	26.99	UB22	22	73	70	20	19
FNBM-24N-xx.xx	1.063	27	1.130	28.7	UB24	24	73	70	22	21
FNBM-24N-xx.xx	1.130	28.71	1.181	29.99	UB24	24	73	70	22	24
FNBM-26N-xx.xx	1.181	30	1.259	31.99	UB26	26	78	75	24	24
FNBM-28N-xx.xx	1.260	32	1.338	33.99	UB28	28	78	75	26	26
FNBM-30N-xx.xx	1.339	34	1.456	36.99	UB30	30	93	90	27	28
FNBM-33N-xx.xx	1.457	37	1.574	39.99	UB33	33	98	95	30	30
FNBM-36N-xx.xx	1.575	40	1.693	43	UB36	36	104	100	33	32
FNBM-36N-xx.xx	1.693	43.01	1.732	43.99	UB36	36	104	100	33	36
FNBM-39N-xx.xx	1.732	44	1.850	46.99	UB39	39	109	105	37	36
FNBM-43N-xx.xx	1.850	47	2.035	51.7	UB43	43	109	105	41	36
FNBM-43N-xx.xx	2.036	51.71	2.047	51.99	UB43	43	109	105	41	41
FNBM-47N-xx.xx	2.047	52	2.244	56.99	UB47	47	114	110	44	46
FNBM-51N-xx.xx	2.244	57	2.386	60.6	UB51	51	120	115	49	46
FNBM-51N-xx.xx	2.386	60.61	2.401	60.99	UB51	51	120	115	49	50
FNBM-56N-xx.xx	2.402	61	2.559	65	UB56	56	120	115	53	54
FNBM-56N-xx.xx	2.559	65.01	2.677	67.99	UB56	56	112	104	53	64
FNBM-62N-xx.xx	2.677	68	2.952	74.99	UB62	62	113	104	59	71
FNBM-68N-xx.xx	2.953	75	3.189	80.99	UB68	68	143	134	65	77
FNBM-75N-xx.xx	3.189	81	3.504	89	UB75	75	143	134	71	86

### STANDARD CUTTING CONDITIONS

See more information

e-catalog



Reference pages: Spare parts → **J142**, Inserts → **J144 - J145**, Guide pads → **J146**,  
 Drill tube (STS) → **J176**

# FINE-BEAM DTS

## FINE-BEAM DTS-EX

Indexable head with external 4-start thread for double tube system (DTS)  
 tool diameter:  $\varnothing 25 - \varnothing 65$  mm (0.984" - 2.559")

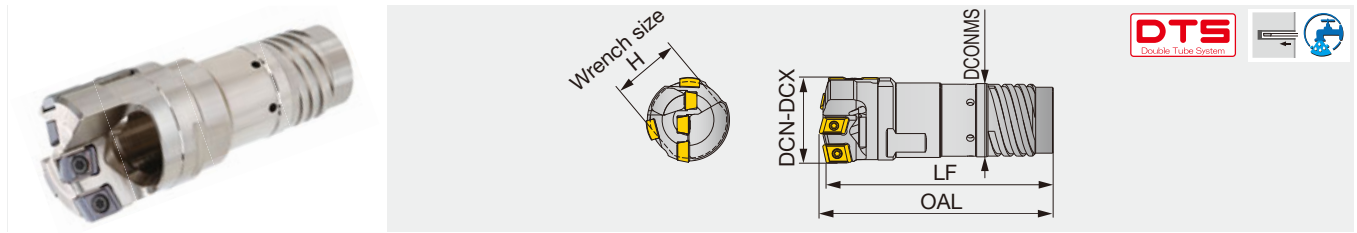

### Standard products

Metric	DC		Drill tube		Drill head			
	(in)	(mm)	Designation	Dia. (mm)	OAL	LF	DCONMS	H
FNBM-11D-50.00	1.969	50	OT11	46.5	114	110	43	41

### Non-standard products (to be supplied on request)

When ordering

**FNBM-\*\*D - XX.XX**

Drill head - Diameter (mm)

e.g. Designation for tool diameter  $\varnothing 30.5$  mm: **FNBM-05D-30.50**

Metric	DCN		DCX		Outer tube		Drill head			
	(in)	(mm)	(in)	(mm)	Designation	Dia. (mm)	OAL	LF	DCONMS	H
FNBM-03D-xx.xx	0.984	25	1.039	26.4	OT03	23.5	73	70	21	22
FNBM-04D-xx.xx	1.040	26.41	1.130	28.7	OT04	26	78	75	23.5	23
FNBM-05D-xx.xx	1.130	28.71	1.220	31	OT05	28	78	75	25.5	24
FNBM-06D-xx.xx	1.221	31.01	1.311	33.3	OT06	30.5	83	80	28	27
FNBM-07D-xx.xx	1.311	33.31	1.425	36.2	OT07	33	93	90	30	29
FNBM-08D-xx.xx	1.426	36.21	1.559	39.6	OT08	35.5	99	95	33	32
FNBM-09D-xx.xx	1.559	39.61	1.693	43	OT09	39	104	100	36	35
FNBM-10D-xx.xx	1.693	43.01	1.850	47	OT10	42.5	104	100	39	38
FNBM-11D-xx.xx	1.851	47.01	2.035	51.7	OT11	46.5	114	110	43	41
FNBM-12D-xx.xx	2.036	51.71	2.213	56.2	OT12	51	120	115	47	46
FNBM-13D-xx.xx	2.213	56.21	2.401	60.99	OT13	55.5	120	115	51	50
FNBM-13D-xx.xx	2.402	61	2.559	65	OT13	55.5	120	115	51	55

### STANDARD CUTTING CONDITIONS

See more information

e-catalog



Reference pages: Spare parts → **J142**, Inserts → **J144 - J145**, Guide pads → **J146**,  
 Drill tube (STS) → **J178**



**SPARE PARTS**



Tool diameter DCN - DCX (mm)	Insert									Guide pad		
	① Peripheral			② Intermediate			③ Central			④		
	Insert	Screw*	Wrench	Insert	Screw*	Wrench	Insert	Screw*	Wrench	Guide pad	Screw	Wrench
25 - 28	FBH0603**R**-P	CSTB-2.2	T-7F	FBM060304R**-I	CSTB-2.2	T-7F	FBM060308L**-C	CSTB-2.2	T-7F	GP06	CSTB-2.2S	T-7F
28.01 - 29.99	FBH0603**R**-P	CSTB-2.2	T-7F	FBM060304R**-I	CSTB-2.2	T-7F	FBM070408L**-C	SR14-560-HG	T-8F	GP06	CSTB-2.2S	T-7F
30 - 35	FBH0804**R**-P	SR14-560-HG	T-8F	FBM070404R**-I	SR14-560-HG	T-8F	FBM070408L**-C	SR14-560-HG	T-8F	GP07	CSTB-3S	T-9F
35.01 - 38	FBH0804**R**-P	SR14-560-HG	T-8F	FBM070404R**-I	SR14-560-HG	T-8F	FBM080408L**-C	SR14-560-HG	T-8F	GP07	CSTB-3S	T-9F
38.01 - 39	FBH0904**R**-P	SR14-560-HG	T-8F	FBM070404R**-I	SR14-560-HG	T-8F	FBM080408L**-C	SR14-560-HG	T-8F	GP07	CSTB-3S	T-9F
39.01 - 41	FBH0904**R**-P	SR14-560-HG	T-8F	FBM070404R**-I	SR14-560-HG	T-8F	FBM080408L**-C	SR14-560-HG	T-8F	GP08	CSTB-3S	T-9F
41.01 - 44	FBH0904**R**-P	SR14-560-HG	T-8F	FBM080404R**-I	SR14-560-HG	T-8F	FBM080408L**-C	SR14-560-HG	T-8F	GP08	CSTB-3S	T-9F
44.01 - 45	FBH0904**R**-P	SR14-560-HG	T-8F	FBM080404R**-I	SR14-560-HG	T-8F	FBM100408L**-C	SR14-560-HG	T-8F	GP08	CSTB-3S	T-9F
45.01 - 47	FBH0904**R**-P	SR14-560-HG	T-8F	FBM080404R**-I	SR14-560-HG	T-8F	FBM100408L**-C	SR14-560-HG	T-8F	GP10S	CSTB-3.5	T-15F
47.01 - 51	FBH1104**R**-P	SR14-560-HG	T-8F	FBM080404R**-I	SR14-560-HG	T-8F	FBM100408L**-C	SR14-560-HG	T-8F	GP10S	CSTB-3.5	T-15F
51.01 - 54	FBH1104**R**-P	SR14-560-HG	T-8F	FBM100404R**-I	SR14-560-HG	T-8F	FBM100408L**-C	SR14-560-HG	T-8F	GP10S	CSTB-3.5	T-15F
54.01 - 57	FBH1104**R**-P	SR14-560-HG	T-8F	FBM100404R**-I	SR14-560-HG	T-8F	FBM130408L**-C	SR14-560-HG	T-8F	GP10S	CSTB-3.5	T-15F
57.01 - 60	FBH1104**R**-P	SR14-560-HG	T-8F	FBM100404R**-I	SR14-560-HG	T-8F	FBM130408L**-C	SR14-560-HG	T-8F	GP12	CSTB-3.5	T-15F
60.01 - 64	FBH1304**R**-P	SR14-560-HG	T-8F	FBM100404R**-I	SR14-560-HG	T-8F	FBM130408L**-C	SR14-560-HG	T-8F	GP12	CSTB-3.5	T-15F
64.01 - 65	FBH1304**R**-P	SR14-560-HG	T-8F	FBM130404R**-I	SR14-560-HG	T-8F	FBM130408L**-C	SR14-560-HG	T-8F	GP12	CSTB-3.5	T-15F

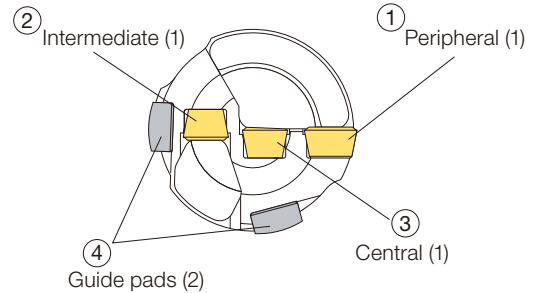
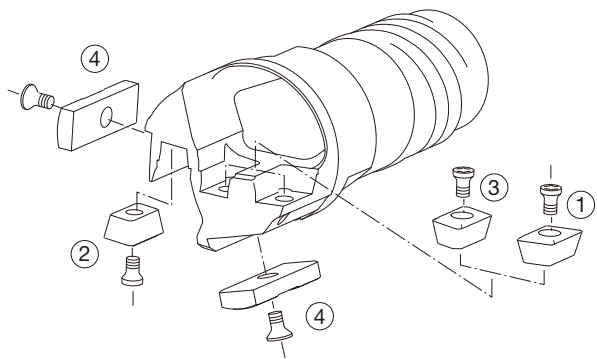

Tool diameter DCN - DCX (mm)	Insert															Guide pad		
	① Peripheral			② Intermediate			③ Intermediate			④ Intermediate			⑤ Central			⑥		
	Insert	Screw*	Wrench	Insert	Screw*	Wrench	Insert	Screw*	Wrench	Insert	Screw*	Wrench	Insert	Screw*	Wrench	Guide pad	Screw	Wrench
65.01 - 71	FBH1104**R**-P	SR 14-560-HG	T-8F	FBM070404R**-I	SR 14-560-HG	T-8F	FBM080404R**-I	SR 14-560-HG	T-8F	FBM080404R**-I	SR 14-560-HG	T-8F	FBM100408L**-C	SR 14-560-HG	T-8F	GP12	CSTB-3.5	T-15F
71.01 - 83	FBH1304**R**-P	SR 14-560-HG	T-8F	FBM080404R**-I	SR 14-560-HG	T-8F	FBM080404R**-I	SR 14-560-HG	T-8F	FBM080404R**-I	SR 14-560-HG	T-8F	FBM100408L**-C	SR 14-560-HG	T-8F	GP12	CSTB-3.5	T-15F
83.01 - 89	FBH1304**R**-P	SR 14-560-HG	T-8F	FBM080404R**-I	SR 14-560-HG	T-8F	FBM100404R**-I	SR 14-560-HG	T-8F	FBM080404R**-I	SR 14-560-HG	T-8F	FBM130408L**-C	SR 14-560-HG	T-8F	GP12	CSTB-3.5	T-15F

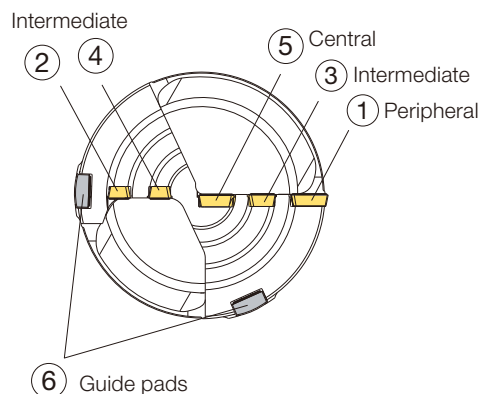
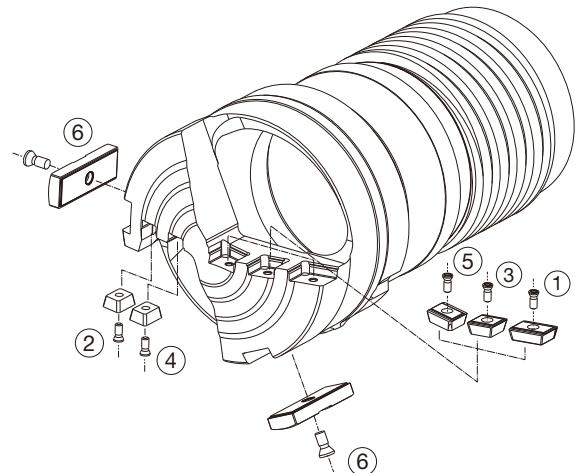

\*See page J143 on size variation of the insert clamping screws.  
 Drill heads come with clamping screws and wrenches but do not include inserts and guide pads. Please purchase inserts and guide pads separately.  
 Recommended clamping torque: CSTB-2.2/CSTB-2.2S = 1 N·m, SR14-560-HG = 1.2 N·m, CSTB-2.5 = 1.3 N·m, CSTB-3S = 2.3 N·m, CSTB-3.5 = 3.5 N·m



## CAUTION

To improve its performance, the FineBeam drill head has undergone design changes. The new drill head has a **guide pad protector**, as shown below, that protects the guide pad from being damaged when retrieving the drill from the hole into the guide bushing after completing machining. Accordingly, the insert clamping screw design for drill head diameters of 30 mm or greater has also been changed. See the list below for details.

When ordering insert clamping screws, below before choosing the screw size, first confirm the drill body design according to the procedure shown.

→ If the drill head has the protector: **Use a screw in the new design**

→ If the drill head has NO protector: **Use a screw in the previous design**

### New design

With guide pad protector

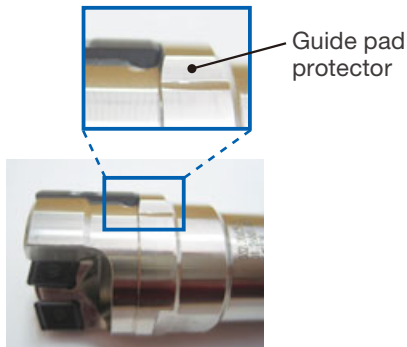

### Conventional design

Without guide pad protector

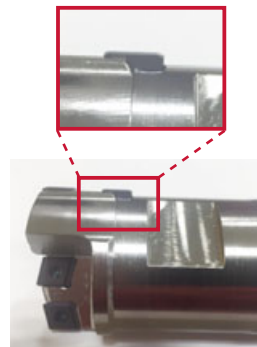

Tool diameter DCN - DCX (mm)	Peripheral insert		Intermediate insert		Central insert	
	Screw		Screw		Screw	
	New	Conventional	New	Conventional	New	Conventional
25 - 28	CSTB-2.2	CSTB-2.2	CSTB-2.2	CSTB-2.2	CSTB-2.2	CSTB-2.2
28.01 - 29.99	CSTB-2.2	CSTB-2.2	CSTB-2.2	CSTB-2.2	CSTB-2.2	CSTB-2.2
30 - 35	<b>SR14-560-HG</b>	CSTB2.5	<b>SR14-560-HG</b>	CSTB2.5	<b>SR14-560-HG</b>	CSTB2.5
35.01 - 38	<b>SR14-560-HG</b>	CSTB2.5	<b>SR14-560-HG</b>	CSTB2.5	<b>SR14-560-HG</b>	CSTB2.5
38.01 - 39	<b>SR14-560-HG</b>	CSTB2.5	<b>SR14-560-HG</b>	CSTB2.5	<b>SR14-560-HG</b>	CSTB2.5
39.01 - 41	<b>SR14-560-HG</b>	CSTB2.5	<b>SR14-560-HG</b>	CSTB2.5	<b>SR14-560-HG</b>	CSTB2.5
41.01 - 44	<b>SR14-560-HG</b>	CSTB2.5	<b>SR14-560-HG</b>	CSTB2.5	<b>SR14-560-HG</b>	CSTB2.5
44.01 - 45	<b>SR14-560-HG</b>	CSTB2.5	<b>SR14-560-HG</b>	CSTB2.5	<b>SR14-560-HG</b>	CSTB2.5
45.01 - 47	<b>SR14-560-HG</b>	CSTB2.5	<b>SR14-560-HG</b>	CSTB2.5	<b>SR14-560-HG</b>	CSTB2.5
47.01 - 51	<b>SR14-560-HG</b>	CSTB2.5	<b>SR14-560-HG</b>	CSTB2.5	<b>SR14-560-HG</b>	CSTB2.5
51.01 - 54	<b>SR14-560-HG</b>	CSTB2.5	<b>SR14-560-HG</b>	CSTB2.5	<b>SR14-560-HG</b>	CSTB2.5
54.01 - 57	<b>SR14-560-HG</b>	CSTB2.5	<b>SR14-560-HG</b>	CSTB2.5	<b>SR14-560-HG</b>	CSTB2.5
57.01 - 60	<b>SR14-560-HG</b>	CSTB2.5	<b>SR14-560-HG</b>	CSTB2.5	<b>SR14-560-HG</b>	CSTB2.5
60.01 - 64	<b>SR14-560-HG</b>	CSTB2.5	<b>SR14-560-HG</b>	CSTB2.5	<b>SR14-560-HG</b>	CSTB2.5
64.01 - 65	<b>SR14-560-HG</b>	CSTB2.5	<b>SR14-560-HG</b>	CSTB2.5	<b>SR14-560-HG</b>	CSTB2.5

The two types of screws are not interchangeable. A wrong screw will not fit the drill head body. Please contact your dealer for further information.

# INSERT

## FBM-C (Central insert)

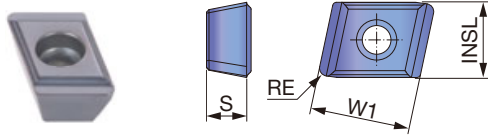

<b>P</b>	Steel	★	☆	☆
<b>M</b>	Stainless	★	☆	☆
<b>K</b>	Cast iron	★	☆	☆
<b>N</b>	Non-ferrous	★	☆	☆
<b>S</b>	Superalloys	☆	☆	★
<b>H</b>	Hard materials	☆	☆	★

★ : First choice  
☆ : Second choice

Designation	INSL (in)	W1 (in)	Coated			S (in)	DCN (in)	DCX (in)	RE (in)
			AH9130	AH725	AH8015				
FBM060308L-G-C	0.217	0.315	●	●	●	0.118	0.984	1.102	0.031
FBM060308L-HF-C	0.217	0.315	●	●	●	0.118	0.984	1.102	0.031
FBM070408L-G-C	0.256	0.394	●	●	●	0.157	1.106	1.378	0.031
FBM070408L-HF-C	0.256	0.394	●	●	●	0.157	1.106	1.378	0.031
FBM080408L-G-C	0.315	0.394	●	●	●	0.157	1.378	1.732	0.031
FBM080408L-HF-C	0.315	0.394	●	●	●	0.157	1.378	1.732	0.031
FBM100408L-G-C	0.374	0.394	●	●	●	0.157	1.733	2.126	0.031
FBM100408L-HF-C	0.374	0.394	●	●	●	0.157	1.733	2.126	0.031
FBM130408L-G-C	0.492	0.394	●	●	●	0.157	2.126	2.559	0.031
FBM130408L-HF-C	0.492	0.394	●	●	●	0.157	2.126	2.559	0.031

● : Line up

## FBM-I (Intermediate insert)

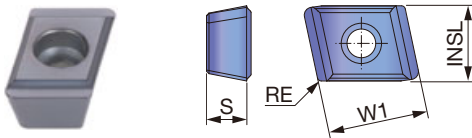

<b>P</b>	Steel	★	☆	☆
<b>M</b>	Stainless	★	☆	☆
<b>K</b>	Cast iron	★	☆	☆
<b>N</b>	Non-ferrous	★	☆	☆
<b>S</b>	Superalloys	☆	☆	★
<b>H</b>	Hard materials	☆	☆	★

★ : First choice  
☆ : Second choice

Designation	INSL (in)	W1 (in)	Coated			S (in)	DCN (in)	DCX (in)	RE (in)
			AH9130	AH725	AH8015				
FBM060304R-DL-I	0.217	0.315	●	●	●	0.118	0.984	1.181	0.016
FBM060304R-G-I	0.217	0.315	●	●	●	0.118	0.984	1.181	0.016
FBM060304R-HF-I	0.217	0.315	●	●	●	0.118	0.984	1.181	0.016
FBM070404R-DL-I	0.256	0.394	●	●	●	0.157	1.181	1.614	0.016
FBM070404R-G-I	0.256	0.394	●	●	●	0.157	1.181	1.614	0.016
FBM070404R-HF-I	0.256	0.394	●	●	●	0.157	1.181	1.614	0.016
FBM080404R-G-I	0.315	0.394	●	●	●	0.157	1.615	2.008	0.016
FBM080404R-HF-I	0.315	0.394	●	●	●	0.157	1.615	2.008	0.016
FBM100404R-G-I	0.374	0.394	●	●	●	0.157	2.008	2.520	0.016
FBM100404R-HF-I	0.374	0.394	●	●	●	0.157	2.008	2.520	0.016
FBM130404R-G-I	0.492	0.394	●	●	●	0.157	2.520	2.559	0.016
FBM130404R-HF-I	0.492	0.394	●	●	●	0.157	2.520	2.559	0.016

● : Line up

## FBH-P (Peripheral insert)

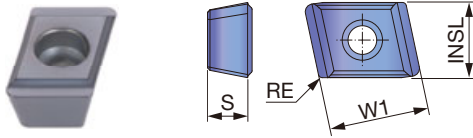

<b>P</b>	Steel	★	☆	☆	☆	
<b>M</b>	Stainless	★	☆	☆	☆	
<b>K</b>	Cast iron	★	☆	☆	☆	
<b>N</b>	Non-ferrous	★	☆	☆	☆	
<b>S</b>	Superalloys	☆	☆	☆	★	
<b>H</b>	Hard materials	☆	☆		★	

★ : First choice  
☆ : Second choice

Designation	INSL (in)	W1 (in)	Coated				S (in)	DCN (in)	DCX (in)	RE (in)
			AH9130	AH725	UC3120	AH8015				
FBH060304R-G-P	0.236	0.315		●	▲		0.118	0.984	1.181	0.016
FBH060308R-G-P	0.236	0.315	●	●		●	0.118	0.984	1.181	0.031
FBH060308R-HF-P	0.236	0.315	●	●		●	0.118	0.984	1.181	0.031
FBH080404R-G-P	0.295	0.394		●	▲		0.157	1.181	1.496	0.016
FBH080408R-G-P	0.295	0.394	●	●		●	0.157	1.181	1.496	0.031
FBH080408R-HF-P	0.295	0.394	●	●		●	0.157	1.181	1.496	0.031
FBH090404R-G-P	0.354	0.394		●	▲		0.157	1.496	1.850	0.016
FBH090408R-G-P	0.354	0.394	●	●		●	0.157	1.496	1.850	0.031
FBH090408R-HF-P	0.354	0.394	●	●		●	0.157	1.496	1.850	0.031
FBH110408R-G-P	0.433	0.394	●	●		●	0.157	1.851	2.362	0.031
FBH110408R-HF-P	0.433	0.394	●	●		●	0.157	1.851	2.362	0.031
FBH130408R-G-P	0.512	0.394	●	●		●	0.157	2.363	2.559	0.031
FBH130408R-HF-P	0.512	0.394	●	●		●	0.157	2.363	2.559	0.031

● : Line up  
▲ : To be discontinued

### Chipbreaker comparison

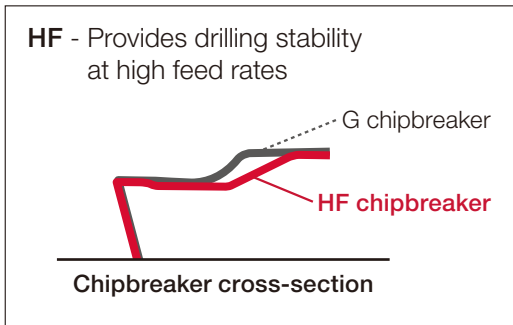

### Insert grade

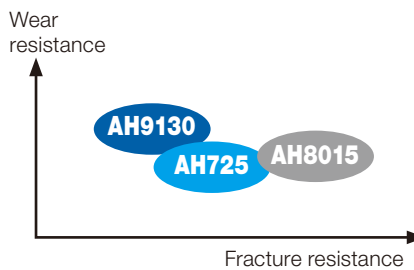

## GUIDE PAD

GP06, 07, 08, 10S, 12

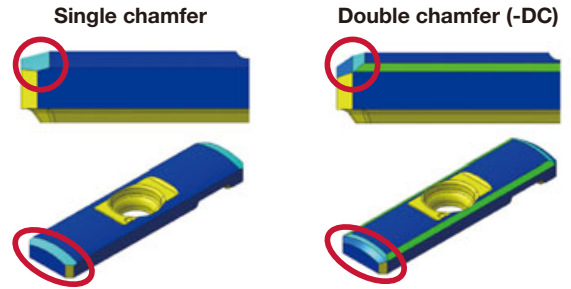
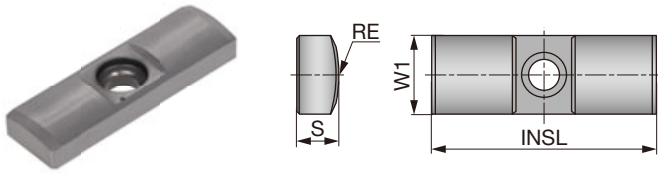

Designation	DCN (in)	DCX (in)	Coated			W1 (in)	INSL (in)	S (in)	RE (in)	Chamfer
			F1122	FH3125	FH3135					
GP06	0.984	1.181	●			0.236	0.787	0.118	0.472	Single
GP06-20-120-DC	0.984	1.181		●	●	0.236	0.787	0.118	0.472	Double
GP07	1.181	1.535	●			0.276	0.787	0.138	0.472	Single
GP07-20-120-DC	1.181	1.535		●	●	0.276	0.787	0.138	0.472	Double
GP08	1.536	1.772	●			0.315	0.984	0.177	0.610	Single
GP08-25-155-DC	1.536	1.772		●	●	0.315	0.984	0.177	0.610	Double
GP10S	1.772	2.244	●			0.394	1.181	0.177	0.787	Single
GP10-30-200-DC	1.772	2.244		●	●	0.394	1.181	0.177	0.787	Double
GP12	2.244	3.504	●			0.472	1.378	0.217	0.984	Single
GP12-35-250-DC	2.244	3.504		●	●	0.472	1.378	0.217	0.984	Double

●: Line up  
 Package quantity = 5 pcs.

### Grade recommendations

ISO	Oil coolant			Water based coolant		
	First choice	Second choice	Third choice	First choice	Second choice	Third choice
<b>P</b>	FH3125	F1122	FH3135	FH3135	FH3125	-
<b>M</b>	FH3135	FH3125	F1122	FH3135	FH3125	-
<b>K</b>	FH3125	F1122	FH3135	FH3135	FH3125	-
<b>N</b>	FH3125	F1122	FH3135	FH3135	FH3125	-
<b>S</b>	FH3135	FH3125	F1122	FH3135	FH3125	-
<b>H</b>	FH3135	FH3125	F1122	FH3135	FH3125	-

Indexable drill head with external 4-start thread for single tube system (STS), diameters adjustable, tool diameter  $\varnothing 38.00 - \varnothing 106.99$  mm ( $\varnothing 1.496'' - \varnothing 4.212''$ ), CICT = 3

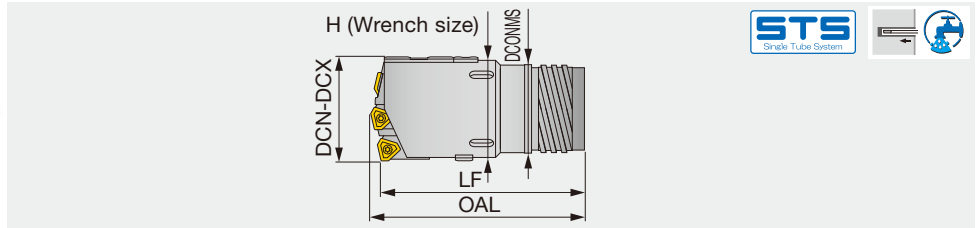

## Standard products

Metric	DC (in)	DC (mm)	CICT	Drill tube		Drill head			
				Designation	Dia. (mm)	OAL	LF	DCONMS	H
KUSTS17E-80.00	3.150	80	3	ST17	75	191	180	70	83
KUSTS18E-90.00	3.543	90	3	ST18	82	193	180	77	96
KUSTS19E-100.00	3.937	100	3	ST19	94	193	180	89	102

## Non-standard products (to be supplied on request)

When ordering

**KUSTS\*\*E** - **XX.XX**

Drill head                      Diameter (mm)

e.g. Designation for tool diameter  $\varnothing 60$  mm: **KUSTS12E-60.00**

Metric	DCN		DCX		CICT	Drill tube		Drill head			
	(in)	(mm)	(in)	(mm)		Designation	Dia. (mm)	OAL	LF	DCONMS	H
KUSTS07E-xx.xx	1.496	38	1.559	39.6	3	ST07	33	90	85	30	37
KUSTS08E-xx.xx	1.559	39.61	1.693	43	3	ST08	36	91	85	33	40
KUSTS09E-xx.xx	1.693	43.01	1.850	47	3	ST09	39	101	95	36	43
KUSTS10E-xx.xx	1.851	47.01	2.035	51.7	3	ST10	43	102	95	39	48
KUSTS11E-xx.xx	2.036	51.71	2.213	56.2	3	ST11	47	107	100	43	52
KUSTS12E-xx.xx	2.213	56.21	2.386	60.6	3	ST12	51	118	110	47	57
KUSTS13E-xx.xx	2.386	60.61	2.559	65	3	ST13	56	119	110	51	61
KUSTS14E-xx.xx	2.559	65	2.637	66.99	3	ST14	56	159	150	52	63
KUSTS15E-xx.xx	2.638	67	2.874	72.99	3	ST15	62	159	150	58	69
KUSTS16E-xx.xx	2.874	73	3.149	79.99	3	ST16	68	160	150	63	76
KUSTS17E-xx.xx	3.150	80	3.425	86.99	3	ST17	75	191	180	70	83
KUSTS18E-xx.xx	3.425	87	3.937	99.99	3	ST18	82	193	180	77	96
KUSTS19E-xx.xx	3.937	100	4.212	106.99	3	ST19	94	193	180	89	102

For drill heads in diameters of  $\varnothing 92$  mm or larger, a filler is attached in place of guide pad.  
Before drilling operation, please adjust drill diameter. For diameter adjustment please see page **L109**.

## STANDARD CUTTING CONDITIONS

See more information

e-catalog



# UNIDEX STS

## UNIDEX STS-IN

Indexable drill head with internal single-start thread for single tube system (STS), diameters adjustable, tool diameter  $\varnothing 38.00 - \varnothing 106.99$  mm ( $\varnothing 1.496'' - \varnothing 4.212''$ ), CICT = 3

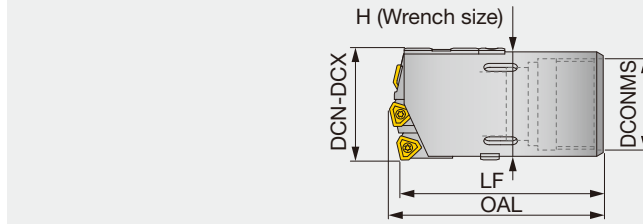

**Non-standard products (to be supplied on request)**

When ordering

**KUSTS\*\* - XX.XX**

Drill head

Diameter (mm)

e.g. Designation for tool diameter  $\varnothing 60$  mm: **KUSTS51-60.00**

Metric	DCN		DCX		CICT	Drill tube			Drill head		
	(in)	(mm)	(in)	(mm)		Designation	Dia. (mm)	OAL	LF	DCONMS	H
KUSTS33-xx.xx	1.496	38	1.574	39.99	3	UB33	33	85	80	30	37
KUSTS36-xx.xx	1.575	40	1.732	43.99	3	UB36	36	86	80	33	41
KUSTS39-xx.xx	1.732	44	1.850	46.99	3	UB39	39	96	90	37	43
KUSTS43-xx.xx	1.850	47	2.047	51.99	3	UB43	43	97	90	41	48
KUSTS47-xx.xx	2.047	52	2.244	56.99	3	UB47	47	107	100	44	53
KUSTS51-xx.xx	2.244	57	2.401	60.99	3	UB51	51	118	110	49	57
KUSTS56-xx.xx	2.402	61	2.677	67.99	3	UB56	56	119	110	53	64
KUSTS62-xx.xx	2.677	68	2.952	74.99	3	UB62	62	129	120	59	71
KUSTS68-xx.xx	2.953	75	3.189	80.99	3	UB68	68	161	150	65	77
KUSTS75-xx.xx	3.189	81	3.582	90.99	3	UB75	75	162	150	71	87
KUSTS82-xx.xx	3.583	91	3.897	98.99	3	UB82	82	162	150	79	95
KUSTS94-xx.xx	3.898	99	4.212	106.99	3	UB94	94	163	150	90	102

For drill heads in diameters of  $\varnothing 92$  mm or larger, a filler is attached in place of guide pad.  
Before drilling operation, please adjust drill diameter. For diameter adjustment please see page **L109**.

### INSERTS

Tool diameter DCN-DCX (mm)	Peripheral insert	Qty	Intermediate insert	Qty	Central insert	Qty
38 - 39.99	NPMX08**R...	1	NPMX08**R...	1	NPMX08**R...	1
40 - 44.99	TPMX14**R...	1	NPMX08**R...	1	NPMX08**R...	1
45 - 47.99	TPMX14**R...	1	NPMX08**R...	1	TPMX14**R...	1
48 - 51.99	TPMX14**R...	1	TPMX14**R...	1	TPMX14**R...	1
52 - 54.99	TPMX17**R...	1	TPMX14**R...	1	TPMX14**R...	1
55 - 57.99	TPMX17**R...	1	TPMX14**R...	1	TPMX17**R...	1
58 - 59.99	TPMX17**R...	1	TPMX17**R...	1	TPMX17**R...	1
60 - 63.99	TPMX17**R...	1	TPMX17**R...	1	TPMX17**R...	1
64 - 67.99	TPMX24**R...	1	TPMX17**R...	1	TPMX17**R...	1
68 - 77.99	TPMX17**R...	1	TPMX24**R...	1	TPMX24**R...	1
78 - 84.99	TPMX24**R...	1	TPMX24**R...	1	TPMX24**R...	1
85 - 91.99	TPMX28**R...	1	TPMX24**R...	1	TPMX24**R...	1
92 - 98.99	TPMX24**R...	1	TPMX28**R...	1	TPMX28**R...	1
99 - 106.99	TPMX28**R...	1	TPMX28**R...	1	TPMX28**R...	1

⊕ **Plus:** The drill diameter can be increased by up to 5 mm by using the Plus parts. A maximum expandable diameter is determined by the peripheral cartridge size used on the drill. See page **J167** for details.

Drill heads come with cartridge, guide pad, filler, protector, sub guide pad and wrench, but do not include inserts.

### STANDARD CUTTING CONDITIONS

See more information

e-catalog



Reference pages: Spare parts → **J149**, Inserts → **J164**, Guide pads → **J165**, Drill tube (STS) → **J176**



**SPARE PARTS**

Tool diameter DCN-DCX (mm)	Cartridge			Guide pad							
	Peripheral	Intermediate	Central	Guide pad		Filler		Protector		Sub guide pad	
	Cartridge ①	Cartridge ②	Cartridge ③	④	Qty	⑤	Qty	⑥	Qty	⑦	Qty
38 - 39.99	OZ05R	IOZ05R	IOZ05R	GP08	2	-	-	GPT08	2	CUG08	1
40 - 44.99	OZ402 - 04	IOZ05R	IOZ05R	GP08	2	-	-	GPT08	2	CUG08	1
45 - 47.99	OZ402 - 04	IOZ05R	IOZ402 - 04	GP10	2	-	-	GPT10	2	CUG08	1
48 - 51.99	OZ402 - 04	IOZ402 - 04	IOZ402 - 04	GP10	2	-	-	GPT10	2	CUG08	1
52 - 54.99	OZ402 - 32	IOZ402 - 04	IOZ402 - 04	GP10	2	-	-	GPT10	2	CUG08	1
55 - 57.99	OZ402 - 32	IOZ402 - 04	IOZ402 - 32	GP10	2	-	-	GPT10	2	CUG08	1
58 - 59.99	OZ402 - 32	IOZ402 - 32	IOZ402 - 32	GP10	2	-	-	GPT10	2	CUG08	1
60 - 63.99	OZ402 - 32	IOZ402 - 32	IOZ402 - 32	GP14	2	-	-	GPT14	2	CUG08	1
64 - 67.99	OZ402 - 43	IOZ402 - 32	IOZ402 - 32	GP14	2	-	-	GPT14	2	CUG10	1
68 - 77.99	OZ402 - 32	IOZ402 - 43	IOZ402 - 43	GP14	2	-	-	GPT14	2	CUG10	1
78 - 84.99	OZ402 - 43	IOZ402 - 43	IOZ402 - 43	GP14	2	-	-	GPT14	2	CUG10	1
85 - 91.99	OZ402 - 63	IOZ402 - 43	IOZ402 - 43	GP14	2	-	-	GPT14	2	CUG10	1
92 - 98.99	OZ402 - 43	IOZ402 - 63	IOZ402 - 63	GP14	2	FILLER14	1	GPT14	2	CUG10	1
99 - 106.99	OZ402 - 63	IOZ402 - 63	IOZ402 - 63	GP18	2	FL18 - M	1	GPT18 - M	2	CUG14 - M	1

See page L108 on handling of filler.

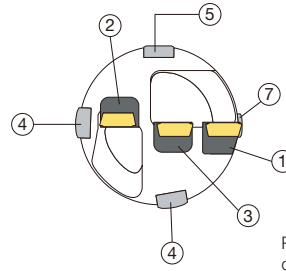
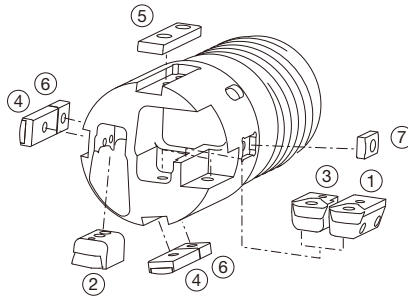

Part positions may vary depending on the drill size.

**SCREWS, WRENCHES (CICT = 3)**

Tool diameter DCN-DCX (mm)	Insert screw					
	Peripheral		Intermediate		Central	
	Cartridge ①		Cartridge ②		Cartridge ③	
	Screw	Wrench	Screw	Wrench	Screw	Wrench
38 - 39.99	CSTB-2.2	T-7D	CSTB-2.2	T-7D	CSTB-2.2	T-7D
40 - 44.99	CSTB-2.5	T-8D	CSTB-2.2	T-7D	CSTB-2.2	T-7D
45 - 47.99	CSTB-2.5	T-8D	CSTB-2.2	T-7D	CSTB-2.5	T-8D
48 - 51.99	CSTB-2.5	T-8D	CSTB-2.5	T-8D	CSTB-2.5	T-8D
52 - 54.99	CSTB-3.5D	T-9D	CSTB-2.5	T-8D	CSTB-2.5	T-8D
55 - 57.99	CSTB-3.5D	T-9D	CSTB-2.5	T-8D	CSTB-3.5D	T-9D
58 - 59.99	CSTB-3.5D	T-9D	CSTB-3.5D	T-9D	CSTB-3.5D	T-9D
60 - 63.99	CSTB-3.5D	T-9D	CSTB-3.5D	T-9D	CSTB-3.5D	T-9D
64 - 67.99	CSTB-4M	T-15D	CSTB-3.5D	T-9D	CSTB-3.5D	T-9D
68 - 77.99	CSTB-3.5D	T-9D	CSTB-4M	T-15D	CSTB-4M	T-15D
78 - 84.99	CSTB-4M	T-15D	CSTB-4M	T-15D	CSTB-4M	T-15D
85 - 91.99	CSTB-5	T-20D	CSTB-4M	T-15D	CSTB-4M	T-15D
92 - 98.99	CSTB-4M	T-15D	CSTB-5	T-20D	CSTB-5	T-20D
99 - 106.99	CSTB-5	T-20D	CSTB-5	T-20D	CSTB-5	T-20D

**SCREWS, WRENCHES (CICT = 3)**

Tool diameter DCN-DCX (mm)	Cartridge screw								Guide pad screw			
	Peripheral				Intermediate		Central		Guide pad / Filler / Protector		Sub guide pad	
	Cartridge ①				Cartridge ②		Cartridge ③					
	Screw	Wrench	Adj. screw	Wrench	Screw	Wrench	Screw	Wrench	Screw	Wrench	Screw	Wrench
38 - 39.99	LS1803RH	H2	AS0003-5	H1.5	CSTB-3	T-9D	CSTB-3	T-9D	CSTB-3S	T-9D	CSTB-3S	T-9D
40 - 44.99	LS1803.5RH	H2.5	AS0004-8	H2	CSTB-3	T-9D	CSTB-3	T-9D	CSTB-3S	T-9D	CSTB-3S	T-9D
45 - 47.99	LS1803.5RH	H2.5	AS0004-8	H2	CSTB-3	T-9D	CSTB-3.5	T-9D	CSTB-4S	T-15D	CSTB-3S	T-9D
48 - 51.99	LS1803.5RH	H2.5	AS0004-8	H2	CSTB-3.5	T-15D	CSTB-3.5	T-15D	CSTB-4S	T-15D	CSTB-3S	T-9D
52 - 54.99	LS1805RH	H3	AS0005-10	H2.5	CSTB-3.5	T-15D	CSTB-3.5	T-15D	CSTB-4S	T-15D	CSTB-3S	T-9D
55 - 57.99	LS1805RH	H3	AS0005-10	H2.5	CSTB-3.5	T-15D	CSTA-5	T-15D	CSTB-4S	T-15D	CSTB-3S	T-9D
58 - 59.99	LS1805RH	H3	AS0005-10	H2.5	CSTA-5	T-15D	CSTA-5	T-15D	CSTB-4S	T-15D	CSTB-3S	T-9D
60 - 63.99	LS1805RH	H3	AS0005-10	H2.5	CSTA-5	T-15D	CSTA-5	T-15D	CSTA-5S	T-15D	CSTB-3S	T-9D
64 - 67.99	LS1806RH	H4	AS0005-15	H2.5	CSTA-5	T-15D	CSTA-5	T-15D	CSTA-5S	T-15D	CSTB-3S	T-9D
68 - 77.99	LS1805RH	H3	AS0005-10	H2.5	LS1206	H3	LS1206	H3	CSTA-5S	T-15D	CSTB-3S	T-9D
78 - 84.99	LS1806RH	H4	AS0005-15	H2.5	LS1206	H3	LS1206	H3	CSTA-5S	T-15D	CSTB-3S	T-9D
85 - 91.99	LS1806RH	H4	AS0006-15	H3	LS1206	H3	LS1206	H3	CSTA-5S	T-15D	CSTB-3S	T-9D
92 - 98.99	LS1806RH	H4	AS0005-15	H2.5	LS1206	H3	LS1206S	H3	CSTA-5S	T-15D	CSTB-3S	T-9D
99 - 106.99	LS1806RH	H4	AS0006-15	H3	LS1206	H3	LS1206S	H3	LS1206S	H3	CSTA-5S	T-15D

Recommended clamping torque: please see page J166.

Grade  
Insert  
Ext. Toolholder  
Int. Toolholder  
Threading  
Grooving  
Milling cutter  
Endmill  
Drilling tool  
Tooling System  
User's Guide  
Index



# UNIDEX STS

## UNIDEX STS-EX

Indexable drill head with external 4-start thread for single tube system (STS), diameters adjustable, tool diameter  $\varnothing 107.00 - \varnothing 168.99$  mm ( $\varnothing 4.231'' - \varnothing 6.653''$ ), CICT = 5

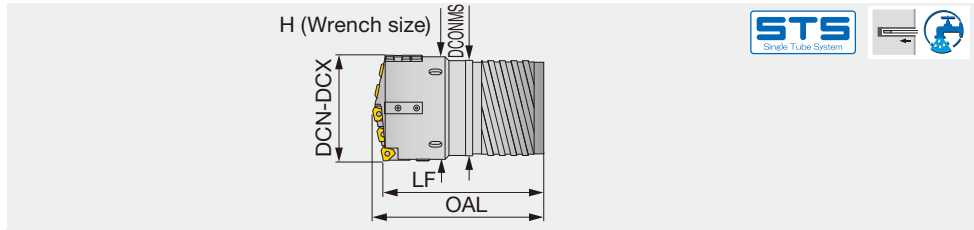

**Non-standard products (to be supplied on request)**

When ordering

**KUSTS\*\*E - XX.XX**

Drill head

Diameter (mm)

e.g. Designation for tool diameter  $\varnothing 150$  mm: **KUSTS23E-150.00**

Metric	DCN		DCX		CICT	Drill tube			Drill head		
	(in)	(mm)	(in)	(mm)		Designation	Dia. (mm)	OAL	LF	DCONMS	H
KUSTS19E-xx.xx	4.213	107	4.409	111.99	5	ST19	94	197	180	89	107
KUSTS20E-xx.xx	4.409	112	4.881	123.99	5	ST20	106	221	205	101	119
KUSTS21E-xx.xx	4.882	124	5.354	135.99	5	ST21	118	222	205	113	131
KUSTS22E-xx.xx	5.354	136	5.826	147.99	5	ST22	130	223	205	125	143
KUSTS23E-xx.xx	5.827	148	6.299	159.99	5	ST23	142	245	225	137	155
KUSTS24E-xx.xx	6.299	160	6.653	168.99	5	ST24	154	246	225	149	164

Before drilling operation, please adjust drill diameter. For diameter adjustment please see page **L109**.

## STANDARD CUTTING CONDITIONS

See more information

e-catalog



Reference pages: Spare parts → **J152**, Inserts → **J151, J164**, Guide pads → **J165**,  
Drill tube (STS) → **J174**

## UNIDEX STS-IN

Indexable drill head with internal single-start thread for single tube system (STS), diameters adjustable, tool diameter  $\varnothing 107.00 - \varnothing 168.99$  mm ( $\varnothing 4.213'' - \varnothing 6.653''$ ), CICT = 5

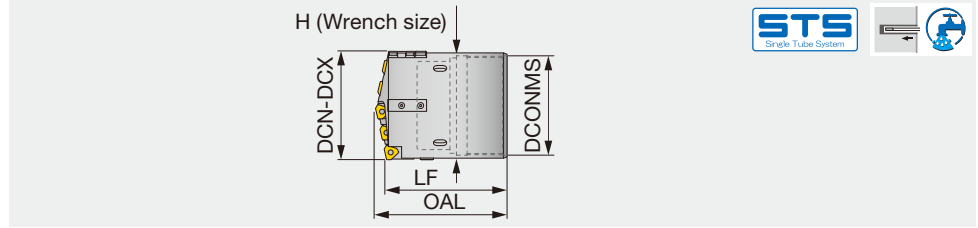

**Non-standard products (to be supplied on request)**

When ordering

<b>KUSTS**</b>	-	<b>XX.XX</b>
Drill head		Diameter (mm)

e.g. Designation for tool diameter  $\varnothing 150$  mm: **KUSTS142-150.00**

Metric	DCN		DCX		CICT	Drill tube			Drill head		
	(in)	(mm)	(in)	(mm)		Designation	Dia. (mm)	OAL	LF	DCONMS	H
KUSTS94-xx.xx	4.213	107	4.370	110.99	5	UB94	94	164	150	90	106
KUSTS106-xx.xx	4.370	111	4.842	122.99	5	UB106	106	165	150	102	118
KUSTS118-xx.xx	4.843	123	5.315	134.99	5	UB118	118	167	150	114	130
KUSTS130-xx.xx	5.315	135	5.866	148.99	5	UB130	130	168	150	126	144
KUSTS142-xx.xx	5.866	149	6.378	161.99	5	UB142	142	170	150	139	157
KUSTS154-xx.xx	6.378	162	6.653	168.99	5	UB154	154	211	190	151	164

Before drilling operation, please adjust drill diameter. For diameter adjustment please see page **L109**.

### INSERTS

Tool diameter DCN-DCX (mm)	Peripheral	Qty	Intermediate	Qty	Intermediate	Qty	Central	Qty
107.00 - 117.99	TPMX24**R...	1	TPMX17**R...	3	-	-	TPMX24**R...	1
118.00 - 135.99	TPMX24**R...	1	TPMX24**R...	3	-	-	TPMX24**R...	1
136.00 - 144.99	TPMX24**R...	1	TPMX24**R...	3	-	-	TPMX28**R...	1
145.00 - 150.99	TPMX24**R...	1	TPMX24**R...	2	TPMX28**R...	1	TPMX28**R...	1
151.00 - 156.99	TPMX28**R...	1	TPMX24**R...	2	TPMX28**R...	1	TPMX28**R...	1
157.00 - 162.99	TPMX28**R...	1	TPMX24**R...	1	TPMX28**R...	2	TPMX28**R...	1
163.00 - 168.99	TPMX28**R...	1	TPMX28**R...	3	-	-	TPMX28**R...	1

⊕ **Plus:** The drill diameter can be increased by up to 5 mm by using the Plus parts. A maximum expandable diameter is determined by the peripheral cartridge size used on the drill. See page **J167** for details.

Drill heads come with cartridge, guide pad, filler, protector, sub guide pad and wrench, but do not include inserts.

## STANDARD CUTTING CONDITIONS

See more information

e-catalog



Reference pages: Spare parts → **J152**, Inserts → **J164**, Guide pads → **J165**,  
Drill tube (STS) → **J176**



### SPARE PARTS

Tool diameter DCN-DCX (mm)	Cartridge				
	Peripheral		Intermediate		Central
	Cartridge ①	Cartridge ②	Cartridge ③	Cartridge ④	Cartridge ⑤
107.00 - 117.99	OZ402 - 43	IOZ402 - 32	IOZ402 - 32	IOZ402 - 32	IOZ402 - 43
118.00 - 135.99	OZ402 - 43	IOZ402 - 43	IOZ402 - 43	IOZ402 - 43	IOZ402 - 43
136.00 - 144.99	OZ402 - 43	IOZ402 - 43	IOZ402 - 43	IOZ402 - 43	IOZ402 - 63
145.00 - 150.99	OZ402 - 43	IOZ402 - 43	IOZ402 - 63	IOZ402 - 43	IOZ402 - 63
151.00 - 156.99	OZ402 - 63	IOZ402 - 43	IOZ402 - 63	IOZ402 - 43	IOZ402 - 63
157.00 - 162.99	OZ402 - 63	IOZ402 - 43	IOZ402 - 63	IOZ402 - 63	IOZ402 - 63
163.00 - 168.99	OZ402 - 63	IOZ402 - 63	IOZ402 - 63	IOZ402 - 63	IOZ402 - 63

### SPARE PARTS

Tool diameter DCN-DCX (mm)	Guide pad							
	Guide pad		Filler		Protector		Sub guide pad	
	⑥	Qty	⑦	Qty	⑧	Qty	⑨	Qty
107.00 - 117.99	GP18	2	FL18 - M	1	GPT18 - M	2	CUG14 - M	1
118.00 - 135.99	GP18	2	FL18 - M	1	GPT18 - M	2	CUG14 - M	1
136.00 - 144.99	GP18	4	FL18 - M	1	GPT18 - M	4	CUG14 - M	1
145.00 - 150.99	GP18	4	FL18 - M	1	GPT18 - M	4	CUG14 - M	1
151.00 - 156.99	GP18	4	FL18 - M	1	GPT18 - M	4	CUG14 - M	1
157.00 - 162.99	GP18	4	FL18 - M	1	GPT18 - M	4	CUG14 - M	1
163.00 - 168.99	GP18	4	FL18 - M	1	GPT18 - M	4	CUG14 - M	1

See page L108 on handling of filler.

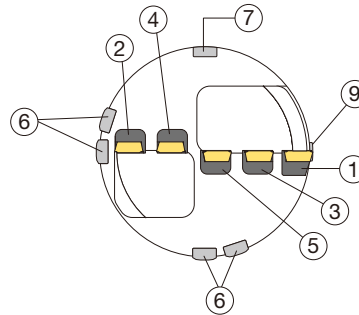
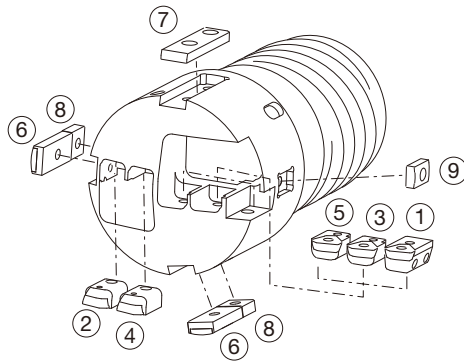

Part positions may vary depending on the drill size.

### SCREWS, WRENCHES (CICT = 5)

Tool diameter DCN-DCX (mm)	Insert screw									
	Peripheral		Cartridge ②		Intermediate		Cartridge ④		Central	
	Screw	Wrench	Screw	Wrench	Screw	Wrench	Screw	Wrench	Screw	Wrench
107.00 - 117.99	CSTB-4M	T-15D	CSTB-3.5D	T-9D	CSTB-3.5D	T-9D	CSTB-3.5D	T-9D	CSTB-4M	T-15D
118.00 - 135.99	CSTB-4M	T-15D	CSTB-4M	T-15D	CSTB-4M	T-15D	CSTB-4M	T-15D	CSTB-4M	T-15D
136.00 - 144.99	CSTB-4M	T-15D	CSTB-4M	T-15D	CSTB-4M	T-15D	CSTB-4M	T-15D	CSTB-5	T-20D
145.00 - 150.99	CSTB-4M	T-15D	CSTB-4M	T-15D	CSTB-5	T-20D	CSTB-4M	T-15D	CSTB-5	T-20D
151.00 - 156.99	CSTB-5	T-20D	CSTB-4M	T-15D	CSTB-5	T-20D	CSTB-4M	T-15D	CSTB-5	T-20D
157.00 - 162.99	CSTB-5	T-20D	CSTB-4M	T-15D	CSTB-5	T-20D	CSTB-5	T-20D	CSTB-5	T-20D
163.00 - 168.99	CSTB-5	T-20D	CSTB-5	T-20D	CSTB-5	T-20D	CSTB-5	T-20D	CSTB-5	T-20D

### SCREWS, WRENCHES (CICT = 5)

Tool diameter DCN-DCX (mm)	Cartridge screw								Guide pad screw			
	Peripheral		Intermediate		Central		Central		Guide pad / Filler / Protector		Sub guide pad	
	Cartridge ①		Cartridge ② - ④		Cartridge ⑤		Cartridge ⑤		Screw		Wrench	
107.00 - 117.99	LS1806RH	H4	AS0005-15	H2.5	CSTA-5	T-15D	LS1206	H3	LS1206S	H3	CSTA-5S	T-15D
118.00 - 135.99	LS1806RH	H4	AS0005-15	H2.5	LS1206	H3	LS1206	H3	LS1206SSS	H3	CSTA-5S	T-15D
136.00 - 144.99	LS1806RH	H4	AS0005-15	H2.5	LS1206	H3	LS1206S	H3	LS1206SSS	H3	CSTA-5S	T-15D
145.00 - 150.99	LS1806RH	H4	AS0005-15	H2.5	LS1206	H3	LS1206S	H3	LS1206SSS	H3	CSTA-5S	T-15D
151.00 - 156.99	LS1806RH	H4	AS0006-15	H3	LS1206	H3L	LS1206S	H3L	LS1206S	H3	CSTA-5S	T-15D
157.00 - 162.99	LS1806RH	H4	AS0006-15	H3	LS1206	H3L	LS1206S	H3L	LS1206S	H3	CSTA-5S	T-15D
163.00 - 168.99	LS1806RH	H4	AS0006-15	H3	LS1206	H3L	LS1206S	H3L	LS1206S	H3	CSTA-5S	T-15D

Recommended clamping torque: please see page J166.

Indexable drill head with external 4-start thread for single tube system (STS), diameters adjustable, tool diameter  $\varnothing 169.00 - \varnothing 232.99$  mm ( $\varnothing 6.654'' - \varnothing 9.173''$ ), CICT = 7

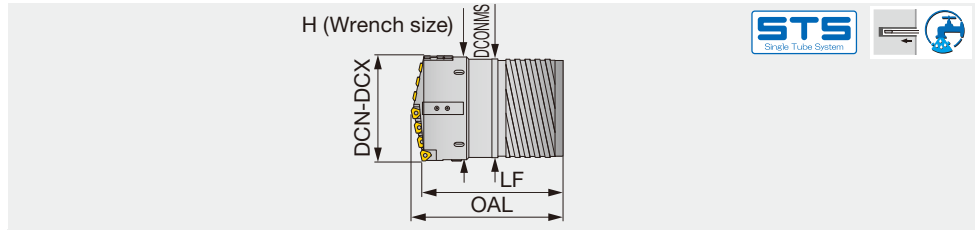

**Non-standard products (to be supplied on request)**

When ordering

**KUSTS\*\*E - XX.XX**

Drill head - Diameter (mm)

e.g. Designation for tool diameter  $\varnothing 185$  mm: **KUSTS26E-185.00**

Metric	DCN		DCX		CICT	Drill tube			Drill head		
	(in)	(mm)	(in)	(mm)		Designation	Dia. (mm)	OAL	LF	DCONMS	H
KUSTS24E-xx.xx	6.654	169	6.771	171.99	7	ST24	154	246	225	149	167
KUSTS25E-xx.xx	6.772	172	7.244	183.99	7	ST25	166	247	225	161	179
KUSTS26E-xx.xx	7.244	184	7.716	195.99	7	ST26	178	267	245	173	191
KUSTS27E-xx.xx	7.717	196	8.189	207.99	7	ST27	190	270	245	185	203
KUSTS28E-xx.xx	8.189	208	8.661	219.99	7	ST28	202	271	245	197	215
KUSTS29E-xx.xx	8.661	220	9.133	231.99	7	ST29	214	293	265	208	227
KUSTS30E-xx.xx	9.134	232	9.173	232.99	7	ST30	226	293	265	220	228

Before drilling operation, please adjust drill diameter. For diameter adjustment please see page **L109**.

**STANDARD CUTTING CONDITIONS**

See more information

e-catalog



Reference pages: Spare parts → **J155**, Inserts → **J154, J164**, Guide pads → **J165**, Drill tube (STS) → **J174**

Grade  
Insert  
Ext. Toolholder  
Int. Toolholder  
Threading  
Grooving  
Miniature tool  
Milling cutter  
Endmill  
Drilling tool  
Tooling System  
User's Guide  
Index



# UNIDEX STS

## UNIDEX STS-IN

Indexable drill head with internal single-start thread for single tube system (STS), diameters adjustable, tool diameter  $\varnothing 169.00 - \varnothing 232.99$  mm ( $\varnothing 6.654'' - \varnothing 9.173''$ ), CICT = 7

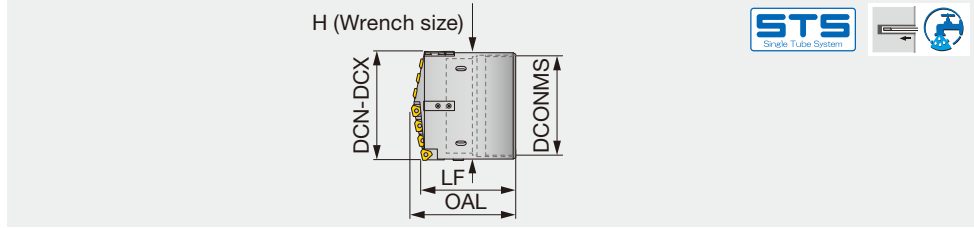

**Non-standard products (to be supplied on request)**

When ordering

**KUSTS\*\* - XX.XX**

Drill head

Diameter (mm)

e.g. Designation for tool diameter  $\varnothing 185$  mm: **KUSTS166-185.00**

Metric	DCN		DCX		CICT	Drill tube			Drill head		
	(in)	(mm)	(in)	(mm)		Designation	Dia. (mm)	OAL	LF	DCONMS	H
KUSTS154-xx.xx	6.654	169	6.850	173.99	7	UB154	154	211	190	151	169
KUSTS166-xx.xx	6.850	174	7.322	185.99	7	UB166	166	213	190	163	181
KUSTS178-xx.xx	7.323	186	7.795	197.99	7	UB178	178	212	190	175	193
KUSTS190-xx.xx	7.795	198	8.267	209.99	7	UB190	190	215	190	187	205
KUSTS202-xx.xx	8.268	210	8.740	221.99	7	UB202	202	217	190	199	217
KUSTS214-xx.xx	8.740	222	9.173	232.99	7	UB214	214	218	190	211	228

Before drilling operation, please adjust drill diameter. For diameter adjustment please see page **L109**.

### INSERTS

Tool diameter DCN-DCX (mm)	Peripheral	Qty	Intermediate	Qty	Intermediate	Qty	Central	Qty
169.00 - 188.99	TPMX24**R...	1	TPMX24**R...	5	-	-	TPMX24**R...	1
189.00 - 196.99	TPMX24**R...	1	TPMX24**R...	5	-	-	TPMX28**R...	1
197.00 - 202.99	TPMX24**R...	1	TPMX24**R...	4	TPMX28**R...	1	TPMX28**R...	1
203.00 - 208.99	TPMX24**R...	1	TPMX24**R...	3	TPMX28**R...	2	TPMX28**R...	1
209.00 - 214.99	TPMX28**R...	1	TPMX24**R...	3	TPMX28**R...	2	TPMX28**R...	1
215.00 - 220.99	TPMX28**R...	1	TPMX24**R...	2	TPMX28**R...	3	TPMX28**R...	1
221.00 - 226.99	TPMX28**R...	1	TPMX24**R...	1	TPMX28**R...	4	TPMX28**R...	1
227.00 - 232.99	TPMX28**R...	1	TPMX28**R...	5	-	-	TPMX28**R...	1

⊕ **Plus:** The drill diameter can be increased by up to 5 mm by using the Plus parts. A maximum expandable diameter is determined by the peripheral cartridge size used on the drill. See page **J167** for details.

Drill heads come with cartridge, guide pad, filler, protector, sub guide pad and wrench, but do not include inserts.

## STANDARD CUTTING CONDITIONS

See more information

e-catalog



Reference pages: Spare parts → **J155**, Inserts → **J164**, Guide pads → **J165**,  
Drill tube (STS) → **J176**



**SPARE PARTS**



Tool diameter DCN-DCX (mm)	Cartridge						
	Peripheral	Intermediate					Central
	Cartridge ①	Cartridge ②	Cartridge ③	Cartridge ④	Cartridge ⑤	Cartridge ⑥	Cartridge ⑦
169.00 - 188.99	OZ402 - 43	IOZ402 - 43	IOZ402 - 43	IOZ402 - 43	IOZ402 - 43	IOZ402 - 43	IOZ402 - 43
189.00 - 196.99	OZ402 - 43	IOZ402 - 43	IOZ402 - 43	IOZ402 - 43	IOZ402 - 43	IOZ402 - 43	IOZ402 - 63
197.00 - 202.99	OZ402 - 43	IOZ402 - 43	IOZ402 - 43	IOZ402 - 43	IOZ402 - 63	IOZ402 - 43	IOZ402 - 63
203.00 - 208.99	OZ402 - 43	IOZ402 - 43	IOZ402 - 63	IOZ402 - 43	IOZ402 - 63	IOZ402 - 43	IOZ402 - 63
209.00 - 214.99	OZ402 - 63	IOZ402 - 43	IOZ402 - 63	IOZ402 - 43	IOZ402 - 63	IOZ402 - 43	IOZ402 - 63
215.00 - 220.99	OZ402 - 63	IOZ402 - 43	IOZ402 - 63	IOZ402 - 43	IOZ402 - 63	IOZ402 - 63	IOZ402 - 63
221.00 - 226.99	OZ402 - 63	IOZ402 - 43	IOZ402 - 63	IOZ402 - 63	IOZ402 - 63	IOZ402 - 63	IOZ402 - 63
227.00 - 232.99	OZ402 - 63	IOZ402 - 63	IOZ402 - 63	IOZ402 - 63	IOZ402 - 63	IOZ402 - 63	IOZ402 - 63

**SPARE PARTS**



Tool diameter DCN-DCX (mm)	Guide pad							
	Guide pad		Filler		Protector		Sub guide pad	
	⑧	Qty	⑨	Qty	⑩	Qty	⑪	Qty
169.00 - 188.99	GP18	4	FL18 - M	1	GPT18 - M	4	CUG14 - M	1
189.00 - 196.99	GP18	4	FL18 - M	1	GPT18 - M	4	CUG14 - M	1
197.00 - 202.99	GP18	4	FL18 - M	1	GPT18 - M	4	CUG14 - M	1
203.00 - 208.99	GP18	4	FL18 - M	1	GPT18 - M	4	CUG14 - M	1
209.00 - 214.99	GP18	4	FL18 - M	1	GPT18 - M	4	CUG14 - M	1
215.00 - 220.99	GP18	4	FL18 - M	1	GPT18 - M	4	CUG14 - M	1
221.00 - 226.99	GP18	4	FL18 - M	1	GPT18 - M	4	CUG14 - M	1
227.00 - 232.99	GP18	4	FL18 - M	1	GPT18 - M	4	CUG14 - M	1

See page L108 on handling of filler.

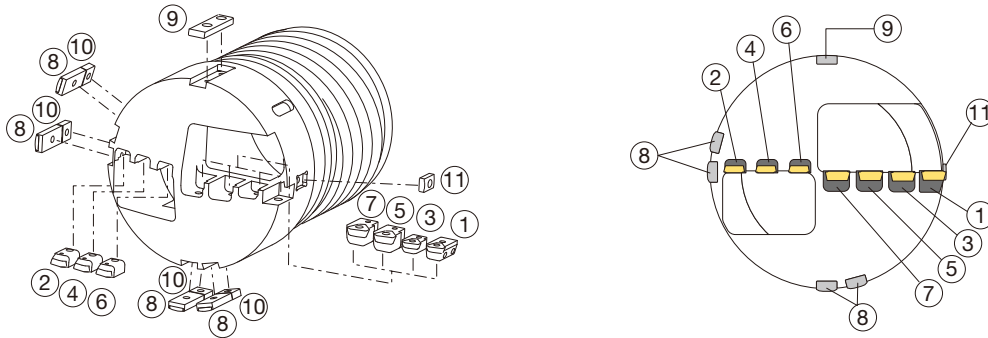

Part positions may vary depending on the drill size.

**SCREWS, WRENCHES  
(CICT = 7)**



Tool diameter DCN-DCX (mm)	Insert screw													
	Peripheral		Intermediate				Central							
	Cartridge ①		Cartridge ②		Cartridge ③		Cartridge ④		Cartridge ⑤		Cartridge ⑥		Cartridge ⑦	
	Screw	Wrench	Screw	Wrench	Screw	Wrench	Screw	Wrench	Screw	Wrench	Screw	Wrench	Screw	Wrench
169.00 - 188.99	CSTB-4M	T-15D	CSTB-4M	T-15D	CSTB-4M	T-15D	CSTB-4M	T-15D	CSTB-4M	T-15D	CSTB-4M	T-15D	CSTB-4M	T-15D
189.00 - 196.99	CSTB-4M	T-15D	CSTB-4M	T-15D	CSTB-4M	T-15D	CSTB-4M	T-15D	CSTB-4M	T-15D	CSTB-4M	T-15D	CSTB-5	T-20D
197.00 - 202.99	CSTB-4M	T-15D	CSTB-4M	T-15D	CSTB-4M	T-15D	CSTB-4M	T-15D	CSTB-5	T-20D	CSTB-4M	T-15D	CSTB-5	T-20D
203.00 - 208.99	CSTB-4M	T-15D	CSTB-4M	T-15D	CSTB-5	T-20D	CSTB-4M	T-15D	CSTB-5	T-20D	CSTB-4M	T-15D	CSTB-5	T-20D
209.00 - 214.99	CSTB-5	T-20D	CSTB-4M	T-15D	CSTB-5	T-20D	CSTB-4M	T-15D	CSTB-5	T-20D	CSTB-4M	T-15D	CSTB-5	T-20D
215.00 - 220.99	CSTB-5	T-20D	CSTB-4M	T-15D	CSTB-5	T-20D	CSTB-4M	T-15D	CSTB-5	T-20D	CSTB-5	T-20D	CSTB-5	T-20D
221.00 - 226.99	CSTB-5	T-20D	CSTB-4M	T-15D	CSTB-5	T-20D	CSTB-5	T-20D	CSTB-5	T-20D	CSTB-5	T-20D	CSTB-5	T-20D
227.00 - 232.99	CSTB-5	T-20D	CSTB-5	T-20D	CSTB-5	T-20D	CSTB-5	T-20D	CSTB-5	T-20D	CSTB-5	T-20D	CSTB-5	T-20D

**SCREWS, WRENCHES  
(CICT = 7)**



Tool diameter DCN-DCX (mm)	Cartridge screw								Guide pad screw			
	Peripheral		Intermediate		Central		Guide pad / Filler / Protector		Sub guide pad			
	Cartridge ①		Cartridge ② - ⑥		Cartridge ⑦							
	Screw	Wrench	Adj. screw	Wrench	Screw	Wrench	Screw	Wrench	Screw	Wrench	Screw	Wrench
169.00 - 188.99	LS1806RH	H4	AS0005-15	H2.5	LS1206	H3L	LS1206	H3L	LS1206SSS	H3	CSTA-5S	T-15D
189.00 - 196.99	LS1806RH	H4	AS0005-15	H2.5	LS1206	H3L	LS1206S	H3L	LS1206SSS	H3	CSTA-5S	T-15D
197.00 - 202.99	LS1806RH	H4	AS0005-15	H2.5	LS1206	H3L	LS1206S	H3L	LS1206SSS	H3	CSTA-5S	T-15D
203.00 - 208.99	LS1806RH	H4	AS0005-15	H2.5	LS1206	H3L	LS1206S	H3L	LS1206SSS	H3	CSTA-5S	T-15D
209.00 - 214.99	LS1806RH	H4	AS0006-15	H3	LS1206	H3L	LS1206S	H3L	LS1206S	H3	CSTA-5S	T-15D
215.00 - 220.99	LS1806RH	H4	AS0006-15	H3	LS1206	H3L	LS1206S	H3L	LS1206S	H3	CSTA-5S	T-15D
221.00 - 226.99	LS1806RH	H4	AS0006-15	H3	LS1206	H3L	LS1206S	H3L	LS1206S	H3	CSTA-5S	T-15D
227.00 - 232.99	LS1806RH	H4	AS0006-15	H3	LS1206	H3L	LS1206S	H3L	LS1206S	H3	CSTA-5S	T-15D

Recommended clamping torque: please see page J166.

Grade  
Insert  
Ext. Toolholder  
Int. Toolholder  
Threading  
Grooving  
Milling cutter  
Miniature tool  
Endmill  
Drilling tool  
Tooling System  
User's Guide  
Index



# UNIDEX STS

## UNIDEX STS-EX

Indexable drill head with external 4-start thread for single tube system (STS), diameters adjustable, tool diameter  $\varnothing 233.00 - \varnothing 291.99$  mm, CICT = 9

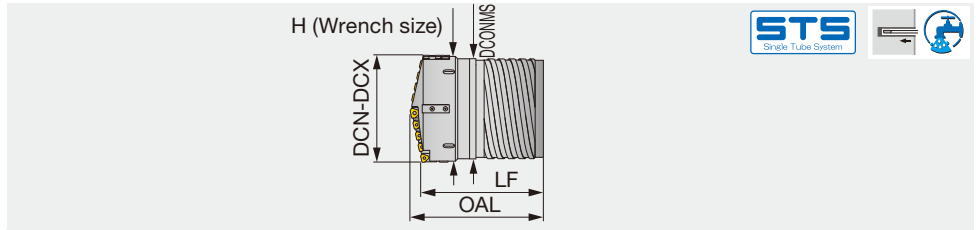

**Non-standard products (to be supplied on request)**

When ordering

**KUSTS\*\*E - XX.XX**

Drill head

Diameter (mm)

e.g. Designation for tool diameter  $\varnothing 240$  mm: KUSTS30E-240.00

Metric	DCN		DCX		CICT	Drill tube			Drill head		
	(in)	(mm)	(in)	(mm)		Designation	Dia. (mm)	OAL	LF	DCONMS	H
KUSTS30E-xx.xx	9.173	233	9.606	243.99	9	ST30	226	294	265	220	239
KUSTS31E-xx.xx	9.606	244	10.078	255.99	9	ST31	238	294	265	232	251
KUSTS32E-xx.xx	10.079	256	10.551	267.99	9	ST32	250	322	290	244	263
KUSTS33E-xx.xx	10.551	268	11.023	279.99	9	ST33	262	323	290	256	275
KUSTS34E-xx.xx	11.024	280	11.496	291.99	9	ST34	274	325	290	268	287

Before drilling operation, please adjust drill diameter. For diameter adjustment please see page **L109**. Larger sizes available upon request. Please contact your dealer for further information.

## STANDARD CUTTING CONDITIONS

See more information

e-catalog



Reference pages: Spare parts → **J158**, Inserts → **J157, J164**, Guide pads → **J165**,  
Drill tube (STS) → **J174**

## UNIDEX STS-IN

Indexable drill head with internal single-start thread for single tube system (STS), diameters adjustable, tool diameter  $\varnothing 233.00 - \varnothing 293.99$  mm ( $\varnothing 9.173'' - \varnothing 11.574''$ ), CICT = 9

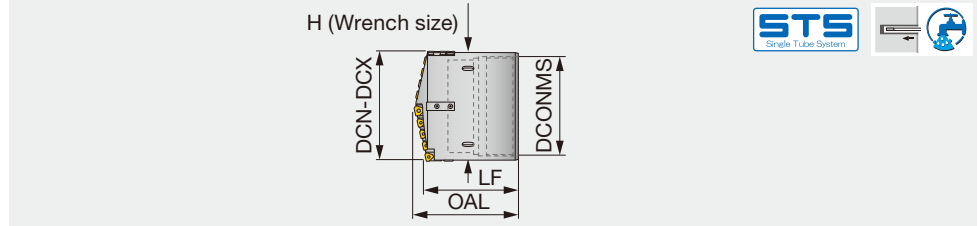

**Non-standard products (to be supplied on request)**

When ordering

<b>KUSTS**</b>	-	<b>XX.XX</b>
Drill head		Diameter (mm)

e.g. Designation for tool diameter  $\varnothing 240$  mm: **KUSTS226-240.00**

Metric	DCN		DCX		CICT	Drill tube			Drill head		
	(in)	(mm)	(in)	(mm)		Designation	Dia. (mm)	OAL	LF	DCNMS	H
KUSTS214-xx.xx	9.173	233	9.212	233.99	9	UB214	214	217	190	211	229
KUSTS226-xx.xx	9.213	234	9.685	245.99	9	UB226	226	219	190	223	241
KUSTS238-xx.xx	9.685	246	10.157	257.99	9	UB238	238	221	190	235	253
KUSTS250-xx.xx	10.157	258	10.630	269.99	9	UB250	250	242	210	245	265
KUSTS262-xx.xx	10.630	270	11.102	281.99	9	UB262	262	244	210	259	277
KUSTS274-xx.xx	11.102	282	11.574	293.99	9	UB274	274	245	210	271	289

Before drilling operation, please adjust drill diameter. For diameter adjustment please see page **L109**.  
Larger sizes available upon request. Please contact your dealer for further information.

### INSERTS

Tool diameter DCN-DCX (mm)	Peripheral	Qty	Intermediate	Qty	Intermediate	Qty	Central	Qty
233.00 - 247.99	TPMX24**R...	1	TPMX24**R...	7	-	-	TPMX28**R...	1
248.00 - 253.99	TPMX28**R...	1	TPMX24**R...	7	-	-	TPMX28**R...	1
254.00 - 258.99	TPMX28**R...	1	TPMX24**R...	6	TPMX28**R...	1	TPMX28**R...	1
259.00 - 264.99	TPMX28**R...	1	TPMX24**R...	5	TPMX28**R...	2	TPMX28**R...	1
265.00 - 271.99	TPMX28**R...	1	TPMX24**R...	4	TPMX28**R...	3	TPMX28**R...	1
272.00 - 275.99	TPMX28**R...	1	TPMX24**R...	3	TPMX28**R...	4	TPMX28**R...	1
276.00 - 284.99	TPMX28**R...	1	TPMX24**R...	2	TPMX28**R...	5	TPMX28**R...	1
285.00 - 289.99	TPMX28**R...	1	TPMX24**R...	1	TPMX28**R...	6	TPMX28**R...	1
290.00 - 293.99	TPMX28**R...	1	TPMX28**R...	7	-	-	TPMX28**R...	1

⊕ **Plus:** The drill diameter can be increased by up to 5 mm by using the Plus parts. A maximum expandable diameter is determined by the peripheral cartridge size used on the drill. See page **J167** for details.  
Drill heads come with cartridge, guide pad, filler, protector, sub guide pad and wrench, but do not include inserts.

## STANDARD CUTTING CONDITIONS

See more information

e-catalog



Reference pages: Spare parts → **J158**, Inserts → **J164**, Guide pads → **J165**,  
Drill tube (STS) → **J176**



### SPARE PARTS

Tool diameter DCN-DCX (mm)	Cartridge							
	Peripheral	Intermediate						
	Cartridge ①	Cartridge ②	Cartridge ③	Cartridge ④	Cartridge ⑤	Cartridge ⑥	Cartridge ⑦	Cartridge ⑧
233.00 - 247.99	OZ402 - 43	IOZ402 - 43	IOZ402 - 43	IOZ402 - 43	IOZ402 - 43	IOZ402 - 43	IOZ402 - 43	IOZ402 - 43
248.00 - 253.99	OZ402 - 63	IOZ402 - 43	IOZ402 - 43	IOZ402 - 43	IOZ402 - 43	IOZ402 - 43	IOZ402 - 43	IOZ402 - 43
254.00 - 258.99	OZ402 - 63	IOZ402 - 43	IOZ402 - 43	IOZ402 - 43	IOZ402 - 43	IOZ402 - 63	IOZ402 - 63	IOZ402 - 43
259.00 - 264.99	OZ402 - 63	IOZ402 - 43	IOZ402 - 43	IOZ402 - 43	IOZ402 - 63	IOZ402 - 43	IOZ402 - 63	IOZ402 - 43
265.00 - 271.99	OZ402 - 63	IOZ402 - 43	IOZ402 - 63	IOZ402 - 43	IOZ402 - 63	IOZ402 - 43	IOZ402 - 63	IOZ402 - 43
272.00 - 275.99	OZ402 - 63	IOZ402 - 43	IOZ402 - 63	IOZ402 - 43	IOZ402 - 63	IOZ402 - 43	IOZ402 - 63	IOZ402 - 63
276.00 - 284.99	OZ402 - 63	IOZ402 - 43	IOZ402 - 63	IOZ402 - 43	IOZ402 - 63	IOZ402 - 63	IOZ402 - 63	IOZ402 - 63
285.00 - 289.99	OZ402 - 63	IOZ402 - 43	IOZ402 - 63	IOZ402 - 63	IOZ402 - 63	IOZ402 - 63	IOZ402 - 63	IOZ402 - 63
290.00 - 293.99	OZ402 - 63	IOZ402 - 63	IOZ402 - 63	IOZ402 - 63	IOZ402 - 63	IOZ402 - 63	IOZ402 - 63	IOZ402 - 63

### SPARE PARTS

Tool diameter DCN-DCX (mm)	Cartridge	Guide pad							
	Central	Guide pad		Filler		Protector		Sub guide pad	
	Cartridge ⑨	⑩	Qty	⑪	Qty	⑫	Qty	⑬	Qty
233.00 - 247.99	IOZ402 - 63	GP18	4	FL18 - M	1	GPT18 - M	4	CUG14 - M	1
248.00 - 253.99	IOZ402 - 63	GP18	4	FL18 - M	1	GPT18 - M	4	CUG14 - M	1
254.00 - 258.99	IOZ402 - 63	GP18	4	FL18 - M	1	GPT18 - M	4	CUG14 - M	1
259.00 - 264.99	IOZ402 - 63	GP18	4	FL18 - M	1	GPT18 - M	4	CUG14 - M	1
265.00 - 271.99	IOZ402 - 63	GP18	4	FL18 - M	1	GPT18 - M	4	CUG14 - M	1
272.00 - 275.99	IOZ402 - 63	GP18	4	FL18 - M	1	GPT18 - M	4	CUG14 - M	1
276.00 - 284.99	IOZ402 - 63	GP18	4	FL18 - M	1	GPT18 - M	4	CUG14 - M	1
285.00 - 289.99	IOZ402 - 63	GP18	4	FL18 - M	1	GPT18 - M	4	CUG14 - M	1
290.00 - 293.99	IOZ402 - 63	GP18	4	FL18 - M	1	GPT18 - M	4	CUG14 - M	1

See page L108 on handling of filler.

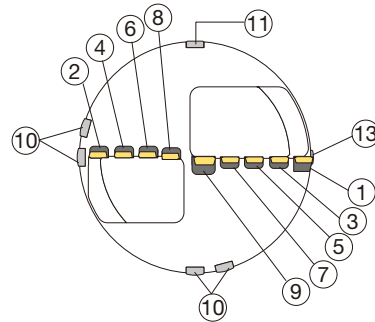
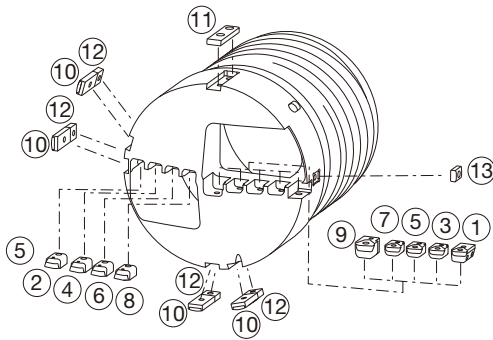

Part positions may vary depending on the drill size.

### SCREWS, WRENCHES (CICT = 9)

Tool diameter DCN-DCX (mm)	Insert screw																			
	Peripheral		Intermediate														Central			
	Cartridge ①		Cartridge ②		Cartridge ③		Cartridge ④		Cartridge ⑤		Cartridge ⑥		Cartridge ⑦		Cartridge ⑧		Cartridge ⑨			
	Screw	Wrench	Screw	Wrench	Screw	Wrench	Screw	Wrench	Screw	Wrench	Screw	Wrench	Screw	Wrench	Screw	Wrench	Screw	Wrench	Screw	Wrench
233.00 - 247.99	CSTB-4M	T-15D	CSTB-4M	T-15D	CSTB-4M	T-15D	CSTB-4M	T-15D	CSTB-4M	T-15D	CSTB-4M	T-15D	CSTB-4M	T-15D	CSTB-4M	T-15D	CSTB-4M	T-15D	CSTB-5	T-20D
248.00 - 253.99	CSTB-5	T-20D	CSTB-4M	T-15D	CSTB-4M	T-15D	CSTB-4M	T-15D	CSTB-4M	T-15D	CSTB-4M	T-15D	CSTB-4M	T-15D	CSTB-4M	T-15D	CSTB-4M	T-15D	CSTB-5	T-20D
254.00 - 258.99	CSTB-5	T-20D	CSTB-4M	T-15D	CSTB-4M	T-15D	CSTB-4M	T-15D	CSTB-4M	T-15D	CSTB-4M	T-15D	CSTB-5	T-20D	CSTB-4M	T-15D	CSTB-5	T-20D	CSTB-5	T-20D
259.00 - 264.99	CSTB-5	T-20D	CSTB-4M	T-15D	CSTB-4M	T-15D	CSTB-4M	T-15D	CSTB-5	T-20D	CSTB-4M	T-15D	CSTB-5	T-20D	CSTB-4M	T-15D	CSTB-5	T-20D	CSTB-5	T-20D
265.00 - 271.99	CSTB-5	T-20D	CSTB-4M	T-15D	CSTB-5	T-20D	CSTB-4M	T-15D	CSTB-5	T-20D	CSTB-4M	T-15D	CSTB-5	T-20D	CSTB-4M	T-15D	CSTB-5	T-20D	CSTB-5	T-20D
272.00 - 275.99	CSTB-5	T-20D	CSTB-4M	T-15D	CSTB-5	T-20D	CSTB-4M	T-15D	CSTB-5	T-20D	CSTB-4M	T-15D	CSTB-5	T-20D	CSTB-5	T-20D	CSTB-5	T-20D	CSTB-5	T-20D
276.00 - 284.99	CSTB-5	T-20D	CSTB-4M	T-15D	CSTB-5	T-20D	CSTB-4M	T-15D	CSTB-5	T-20D	CSTB-5	T-20D	CSTB-5	T-20D	CSTB-5	T-20D	CSTB-5	T-20D	CSTB-5	T-20D
285.00 - 289.99	CSTB-5	T-20D	CSTB-4M	T-15D	CSTB-5	T-20D	CSTB-5	T-20D	CSTB-5	T-20D	CSTB-5	T-20D	CSTB-5	T-20D	CSTB-5	T-20D	CSTB-5	T-20D	CSTB-5	T-20D
290.00 - 293.99	CSTB-5	T-20D	CSTB-5	T-20D	CSTB-5	T-20D	CSTB-5	T-20D	CSTB-5	T-20D	CSTB-5	T-20D	CSTB-5	T-20D	CSTB-5	T-20D	CSTB-5	T-20D	CSTB-5	T-20D

### SCREWS, WRENCHES (CICT = 9)

Tool diameter DCN-DCX (mm)	Cartridge screw										Guide pad screw			
	Peripheral				Intermediate		Central		Guide pad / Filler / Protector		Sub guide pad			
	Cartridge ①		Cartridge ② - ⑧		Cartridge ⑨		Cartridge ⑨		Cartridge ⑨		Cartridge ⑨			
	Screw	Wrench	Adj. screw	Wrench	Screw	Wrench	Screw	Wrench	Screw	Wrench	Screw	Wrench	Screw	Wrench
233.00 - 247.99	LS1806RH	H4	AS0005-15	H2.5	LS1206	H3L	LS1206S	H3L	LS1206SSS	H3	CSTA-5S	T-15D		
248.00 - 253.99	LS1806RH	H4	AS0006-15	H3	LS1206	H3L	LS1206S	H3L	LS1206S	H3	CSTA-5S	T-15D		
254.00 - 258.99	LS1806RH	H4	AS0006-15	H3	LS1206	H3L	LS1206S	H3L	LS1206S	H3	CSTA-5S	T-15D		
259.00 - 264.99	LS1806RH	H4	AS0006-15	H3	LS1206	H3L	LS1206S	H3L	LS1206S	H3	CSTA-5S	T-15D		
265.00 - 271.99	LS1806RH	H4	AS0006-15	H3	LS1206	H3L	LS1206S	H3L	LS1206S	H3	CSTA-5S	T-15D		
272.00 - 275.99	LS1806RH	H4	AS0006-15	H3	LS1206	H3L	LS1206S	H3L	LS1206S	H3	CSTA-5S	T-15D		
276.00 - 284.99	LS1806RH	H4	AS0006-15	H3	LS1206	H3L	LS1206S	H3L	LS1206S	H3	CSTA-5S	T-15D		
285.00 - 289.99	LS1806RH	H4	AS0006-15	H3	LS1206	H3L	LS1206S	H3L	LS1206S	H3	CSTA-5S	T-15D		
290.00 - 293.99	LS1806RH	H4	AS0006-15	H3	LS1206	H3L	LS1206S	H3L	LS1206S	H3	CSTA-5S	T-15D		

Recommended clamping torque: please see page J166.

Indexable drill head with external 4-start thread for double tube system (DTS), diameters adjustable, tool diameter  $\varnothing 38.00 - \varnothing 106.99$  mm ( $\varnothing 1.496'' - \varnothing 4.212''$ ), CICT = 3

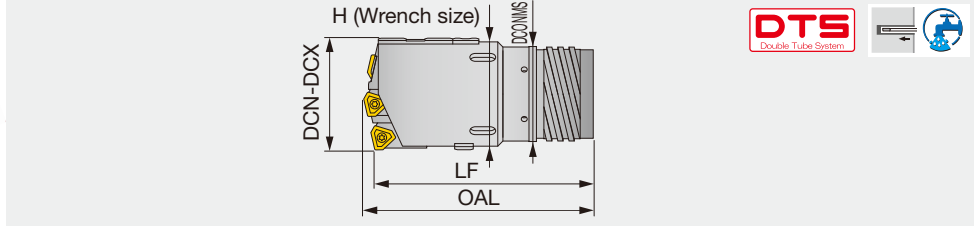

**Non-standard products (to be supplied on request)**

When ordering

**KUDTS\*\*E - XX.XX**

Drill head      Diameter (mm)

e.g. Designation for tool diameter  $\varnothing 60$  mm: **KUDTS13E-60.00**

Metric	DCN		DCX		CICT	Outer tube			Drill head		
	(in)	(mm)	(in)	(mm)		Designation	Dia. (mm)	OAL	LF	DCONMS	H
KUDTS08E-xx.xx	1.496	38	1.559	39.6	3	OT08	35.5	90	85	33	37
KUDTS09E-xx.xx	1.559	39.61	1.693	43	3	OT09	39	91	85	36	40
KUDTS10E-xx.xx	1.693	43.01	1.850	47	3	OT10	42.5	101	95	39	43
KUDTS11E-xx.xx	1.851	47.01	2.035	51.7	3	OT11	46.5	102	100	43	48
KUDTS12E-xx.xx	2.036	51.71	2.213	56.2	3	OT12	51	107	100	47	52
KUDTS13E-xx.xx	2.213	56.21	2.559	65	3	OT13	55.5	119	110	51	61
KUDTS14E-xx.xx	2.559	65	2.637	66.99	3	OT14	56	159	150	52	63
KUDTS15E-xx.xx	2.638	67	2.874	72.99	3	OT15	62	159	150	58	69
KUDTS16E-xx.xx	2.874	73	3.149	79.99	3	OT16	68	160	150	63	76
KUDTS17E-xx.xx	3.150	80	3.425	86.99	3	OT17	75	191	180	70	83
KUDTS18E-xx.xx	3.425	87	3.937	99.99	3	OT18	82	193	180	77	96
KUDTS19E-xx.xx	3.937	100	4.212	106.99	3	OT19	94	193	180	89	102

For drill heads in diameters of  $\varnothing 92$  mm or larger, a filler is attached in place of guide pad.  
Before drilling operation, please adjust drill diameter. For diameter adjustment please see page **L109**.

### INSERTS

Tool diameter DCN-DCX (mm)	Peripheral insert	Qty	Intermediate insert	Qty	Central insert	Qty
38 - 39.99	NPMX08**R...	1	NPMX08**R...	1	NPMX08**R...	1
40 - 44.99	TPMX14**R...	1	NPMX08**R...	1	NPMX08**R...	1
45 - 47.99	TPMX14**R...	1	NPMX08**R...	1	TPMX14**R...	1
48 - 51.99	TPMX14**R...	1	TPMX14**R...	1	TPMX14**R...	1
52 - 54.99	TPMX17**R...	1	TPMX14**R...	1	TPMX14**R...	1
55 - 57.99	TPMX17**R...	1	TPMX14**R...	1	TPMX17**R...	1
58 - 59.99	TPMX17**R...	1	TPMX17**R...	1	TPMX17**R...	1
60 - 63.99	TPMX17**R...	1	TPMX17**R...	1	TPMX17**R...	1
64 - 67.99	TPMX24**R...	1	TPMX17**R...	1	TPMX17**R...	1
68 - 77.99	TPMX17**R...	1	TPMX24**R...	1	TPMX24**R...	1
78 - 84.99	TPMX24**R...	1	TPMX24**R...	1	TPMX24**R...	1
85 - 91.99	TPMX28**R...	1	TPMX24**R...	1	TPMX24**R...	1
92 - 98.99	TPMX24**R...	1	TPMX28**R...	1	TPMX28**R...	1
99 - 106.99	TPMX28**R...	1	TPMX28**R...	1	TPMX28**R...	1

⊕ **Plus:** The drill diameter can be increased by up to 5 mm by using the Plus parts. A maximum expandable diameter is determined by the peripheral cartridge size used on the drill. See page **J167** for details.

Drill heads come with cartridge, guide pad, filler, protector, sub guide pad and wrench, but do not include inserts.

## STANDARD CUTTING CONDITIONS

See more information

e-catalog



Reference pages: Spare parts → **J160**, Inserts → **J164**, Guide pads → **J165**, Drill tube (STS) → **J178**



### SPARE PARTS

Tool diameter DCN-DCX (mm)	Cartridge			Guide pad							
	Peripheral	Intermediate	Central	Guide pad		Filler		Protector		Sub guide pad	
	Cartridge ①	Cartridge ②	Cartridge ③	④	Qty	⑤	Qty	⑥	Qty	⑦	Qty
38 - 39.99	OZ05R	IOZ05R	IOZ05R	GP08	2	-	-	GPT08	2	CUG08	1
40 - 44.99	OZ402 - 04	IOZ05R	IOZ05R	GP08	2	-	-	GPT08	2	CUG08	1
45 - 47.99	OZ402 - 04	IOZ05R	IOZ402 - 04	GP10	2	-	-	GPT10	2	CUG08	1
48 - 51.99	OZ402 - 04	IOZ402 - 04	IOZ402 - 04	GP10	2	-	-	GPT10	2	CUG08	1
52 - 54.99	OZ402 - 32	IOZ402 - 04	IOZ402 - 04	GP10	2	-	-	GPT10	2	CUG08	1
55 - 57.99	OZ402 - 32	IOZ402 - 04	IOZ402 - 32	GP10	2	-	-	GPT10	2	CUG08	1
58 - 59.99	OZ402 - 32	IOZ402 - 32	IOZ402 - 32	GP10	2	-	-	GPT10	2	CUG08	1
60 - 63.99	OZ402 - 32	IOZ402 - 32	IOZ402 - 32	GP14	2	-	-	GPT14	2	CUG08	1
64 - 67.99	OZ402 - 43	IOZ402 - 32	IOZ402 - 32	GP14	2	-	-	GPT14	2	CUG10	1
68 - 77.99	OZ402 - 32	IOZ402 - 43	IOZ402 - 43	GP14	2	-	-	GPT14	2	CUG10	1
78 - 84.99	OZ402 - 43	IOZ402 - 43	IOZ402 - 43	GP14	2	-	-	GPT14	2	CUG10	1
85 - 91.99	OZ402 - 63	IOZ402 - 43	IOZ402 - 43	GP14	2	-	-	GPT14	2	CUG10	1
92 - 98.99	OZ402 - 43	IOZ402 - 63	IOZ402 - 63	GP14	2	FILLER14	1	GPT14	2	CUG10	1
99 - 106.99	OZ402 - 63	IOZ402 - 63	IOZ402 - 63	GP18	2	FL18 - M	1	GPT18 - M	2	CUG14 - M	1

See page L108 on handling of filler.

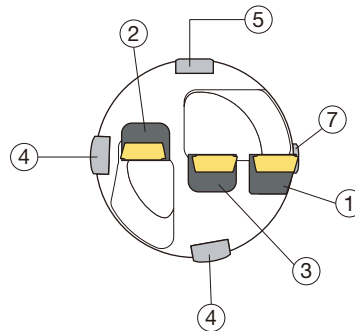
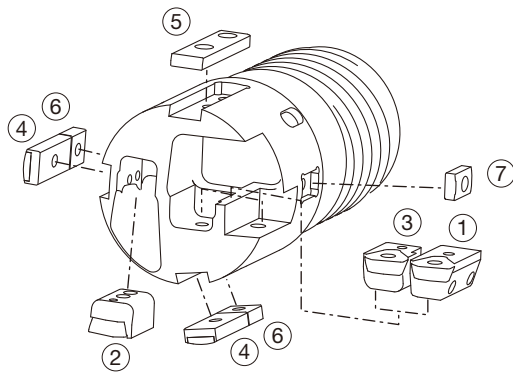

Part positions may vary depending on the drill size.

### SCREWS, WRENCHES (CICT = 3)

Tool diameter DCN-DCX (mm)	Insert screw					
	Peripheral		Intermediate		Central	
	Cartridge ①		Cartridge ②		Cartridge ③	
	Screw	Wrench	Screw	Wrench	Screw	Wrench
38 - 39.99	CSTB-2.2	T-7D	CSTB-2.2	T-7D	CSTB-2.2	T-7D
40 - 44.99	CSTB-2.5	T-8D	CSTB-2.2	T-7D	CSTB-2.2	T-7D
45 - 47.99	CSTB-2.5	T-8D	CSTB-2.2	T-7D	CSTB-2.5	T-8D
48 - 51.99	CSTB-2.5	T-8D	CSTB-2.5	T-8D	CSTB-2.5	T-8D
52 - 54.99	CSTB-3.5D	T-9D	CSTB-2.5	T-8D	CSTB-2.5	T-8D
55 - 57.99	CSTB-3.5D	T-9D	CSTB-2.5	T-8D	CSTB-3.5D	T-9D
58 - 59.99	CSTB-3.5D	T-9D	CSTB-3.5D	T-9D	CSTB-3.5D	T-9D
60 - 63.99	CSTB-3.5D	T-9D	CSTB-3.5D	T-9D	CSTB-3.5D	T-9D
64 - 67.99	CSTB-4M	T-15D	CSTB-3.5D	T-9D	CSTB-3.5D	T-9D
68 - 77.99	CSTB-3.5D	T-9D	CSTB-4M	T-15D	CSTB-4M	T-15D
78 - 84.99	CSTB-4M	T-15D	CSTB-4M	T-15D	CSTB-4M	T-15D
85 - 91.99	CSTB-5	T-20D	CSTB-4M	T-15D	CSTB-4M	T-15D
92 - 98.99	CSTB-4M	T-15D	CSTB-5	T-20D	CSTB-5	T-20D
99 - 106.99	CSTB-5	T-20D	CSTB-5	T-20D	CSTB-5	T-20D

### SCREWS, WRENCHES (CICT = 3)

Tool diameter DCN-DCX (mm)	Cartridge screw								Guide pad screw			
	Peripheral				Intermediate		Central		Guide pad / Filler / Protector		Sub guide pad	
	Cartridge ①				Cartridge ②		Cartridge ③					
	Screw	Wrench	Adj. screw	Wrench	Screw	Wrench	Screw	Wrench	Screw	Wrench	Screw	Wrench
38 - 39.99	LS1803RH	H2	AS0003-5	H1.5	CSTB-3	T-9D	CSTB-3	T-9D	CSTB-3S	T-9D	CSTB-3S	T-9D
40 - 44.99	LS1803.5RH	H2.5	AS0004-8	H2	CSTB-3	T-9D	CSTB-3	T-9D	CSTB-3S	T-9D	CSTB-3S	T-9D
45 - 47.99	LS1803.5RH	H2.5	AS0004-8	H2	CSTB-3	T-9D	CSTB-3.5	T-9D	CSTB-4S	T-15D	CSTB-3S	T-9D
48 - 51.99	LS1803.5RH	H2.5	AS0004-8	H2	CSTB-3.5	T-15D	CSTB-3.5	T-15D	CSTB-4S	T-15D	CSTB-3S	T-9D
52 - 54.99	LS1805RH	H3	AS0005-10	H2.5	CSTB-3.5	T-15D	CSTB-3.5	T-15D	CSTB-4S	T-15D	CSTB-3S	T-9D
55 - 57.99	LS1805RH	H3	AS0005-10	H2.5	CSTB-3.5	T-15D	CSTA-5	T-15D	CSTB-4S	T-15D	CSTB-3S	T-9D
58 - 59.99	LS1805RH	H3	AS0005-10	H2.5	CSTA-5	T-15D	CSTA-5	T-15D	CSTB-4S	T-15D	CSTB-3S	T-9D
60 - 63.99	LS1805RH	H3	AS0005-10	H2.5	CSTA-5	T-15D	CSTA-5	T-15D	CSTA-5S	T-15D	CSTB-3S	T-9D
64 - 67.99	LS1806RH	H4	AS0005-15	H2.5	CSTA-5	T-15D	CSTA-5	T-15D	CSTA-5S	T-15D	CSTB-3S	T-9D
68 - 77.99	LS1805RH	H3	AS0005-10	H2.5	LS1206	H3	LS1206	H3	CSTA-5S	T-15D	CSTB-3S	T-9D
78 - 84.99	LS1806RH	H4	AS0005-15	H2.5	LS1206	H3	LS1206	H3	CSTA-5S	T-15D	CSTB-3S	T-9D
85 - 91.99	LS1806RH	H4	AS0006-15	H3	LS1206	H3	LS1206	H3	CSTA-5S	T-15D	CSTB-3S	T-9D
92 - 98.99	LS1806RH	H4	AS0005-15	H2.5	LS1206	H3	LS1206S	H3	CSTA-5S	T-15D	CSTB-3S	T-9D
99 - 106.99	LS1806RH	H4	AS0006-15	H3	LS1206	H3	LS1206S	H3	LS1206S	H3	CSTA-5S	T-15D

Recommended clamping torque: please see page J166.



Indexable drill head with external 4-start thread for double tube system (DTS), diameters adjustable, tool diameter  $\varnothing 107.00 - \varnothing 168.99$  mm ( $\varnothing 4.213'' - \varnothing 6.653''$ ), CICT = 5

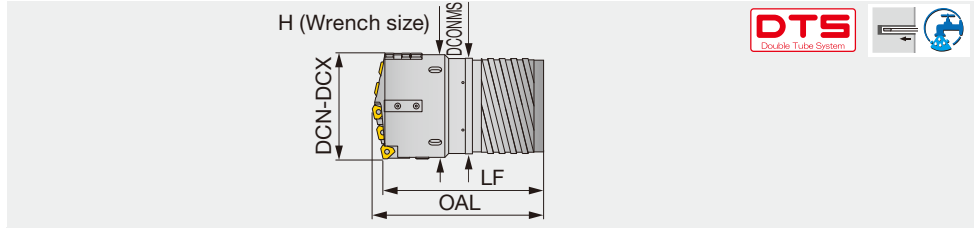

## Non-standard products (to be supplied on request)

When ordering

**KUDTS\*\*E - XX.XX**

Drill head

Diameter (mm)

e.g. Designation for tool diameter  $\varnothing 150$  mm: KUDTS23E-150.00

Metric	DCN		DCX		CICT	Outer tube			Drill head		
	(in)	(mm)	(in)	(mm)		Designation	Dia. (mm)	OAL	LF	DCONMS	H
KUDTS19E-xx.xx	4.213	107	4.409	111.99	5	OT19	94	197	180	89	107
KUDTS20E-xx.xx	4.409	112	4.881	123.99	5	OT20	106	221	205	101	119
KUDTS21E-xx.xx	4.882	124	5.354	135.99	5	OT21	118	222	205	113	131
KUDTS22E-xx.xx	5.354	136	5.826	147.99	5	OT22	130	223	205	125	143
KUDTS23E-xx.xx	5.827	148	6.299	159.99	5	OT23	142	245	225	137	155
KUDTS24E-xx.xx	6.299	160	6.653	168.99	5	OT24	154	246	225	149	164

Before drilling operation, please adjust drill diameter. For diameter adjustment please see page L109.

## INSERTS

Tool diameter DCN-DCX (mm)	Peripheral	Qty	Intermediate	Qty	Intermediate	Qty	Central	Qty
107.00 - 117.99	TPMX24**R...	1	TPMX17**R...	3	-	-	TPMX24**R...	1
118.00 - 135.99	TPMX24**R...	1	TPMX24**R...	3	-	-	TPMX24**R...	1
136.00 - 144.99	TPMX24**R...	1	TPMX24**R...	3	-	-	TPMX28**R...	1
145.00 - 150.99	TPMX24**R...	1	TPMX24**R...	2	TPMX28**R...	1	TPMX28**R...	1
151.00 - 156.99	TPMX28**R...	1	TPMX24**R...	2	TPMX28**R...	1	TPMX28**R...	1
157.00 - 162.99	TPMX28**R...	1	TPMX24**R...	1	TPMX28**R...	2	TPMX28**R...	1
163.00 - 168.99	TPMX28**R...	1	TPMX28**R...	3	-	-	TPMX28**R...	1

⊕ **Plus:** The drill diameter can be increased by up to 5 mm by using the Plus parts. A maximum expandable diameter is determined by the peripheral cartridge size used on the drill. See page J167 for details.

Drill heads come with cartridge, guide pad, filler, protector, sub guide pad and wrench, but do not include inserts.

## STANDARD CUTTING CONDITIONS

See more information

e-catalog



### SPARE PARTS

Tool diameter DCN-DCX (mm)	Cartridge				
	Peripheral	Intermediate			Central
	Cartridge ①	Cartridge ②	Cartridge ③	Cartridge ④	Cartridge ⑤
107.00 - 117.99	OZ402 - 43	IOZ402 - 32	IOZ402 - 32	IOZ402 - 32	IOZ402 - 43
118.00 - 135.99	OZ402 - 43	IOZ402 - 43	IOZ402 - 43	IOZ402 - 43	IOZ402 - 43
136.00 - 144.99	OZ402 - 43	IOZ402 - 43	IOZ402 - 43	IOZ402 - 43	IOZ402 - 63
145.00 - 150.99	OZ402 - 43	IOZ402 - 43	IOZ402 - 63	IOZ402 - 43	IOZ402 - 63
151.00 - 156.99	OZ402 - 63	IOZ402 - 43	IOZ402 - 63	IOZ402 - 43	IOZ402 - 63
157.00 - 162.99	OZ402 - 63	IOZ402 - 43	IOZ402 - 63	IOZ402 - 63	IOZ402 - 63
163.00 - 168.99	OZ402 - 63	IOZ402 - 63	IOZ402 - 63	IOZ402 - 63	IOZ402 - 63

### SPARE PARTS

Tool diameter DCN-DCX (mm)	Guide pad							
	Guide pad		Filler		Protector		Sub guide pad	
	⑥	Qty	⑦	Qty	⑧	Qty	⑨	Qty
107.00 - 117.99	GP18	2	FL18 - M	1	GPT18 - M	2	CUG14 - M	1
118.00 - 135.99	GP18	2	FL18 - M	1	GPT18 - M	2	CUG14 - M	1
136.00 - 144.99	GP18	4	FL18 - M	1	GPT18 - M	4	CUG14 - M	1
145.00 - 150.99	GP18	4	FL18 - M	1	GPT18 - M	4	CUG14 - M	1
151.00 - 156.99	GP18	4	FL18 - M	1	GPT18 - M	4	CUG14 - M	1
157.00 - 162.99	GP18	4	FL18 - M	1	GPT18 - M	4	CUG14 - M	1
163.00 - 168.99	GP18	4	FL18 - M	1	GPT18 - M	4	CUG14 - M	1

See page L108 on handling of filler.

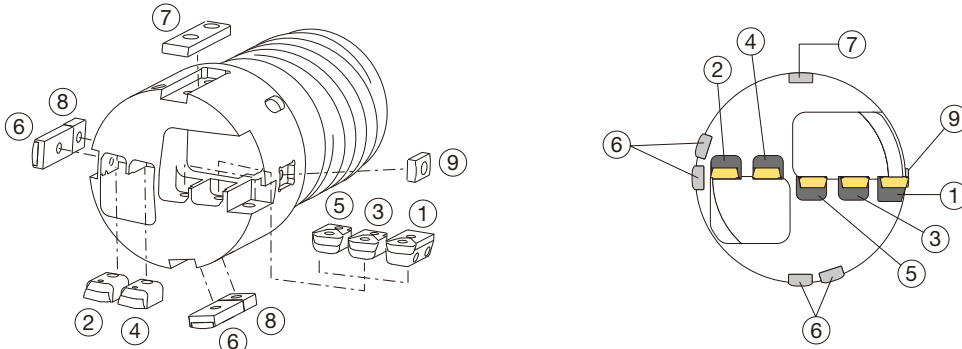

Part positions may vary depending on the drill size.

### SCREWS, WRENCHES (CICT = 5)

Tool diameter DCN-DCX (mm)	Insert screw									
	Peripheral		Intermediate				Central			
	Cartridge ①		Cartridge ②		Cartridge ③		Cartridge ④		Cartridge ⑤	
	Screw	Wrench	Screw	Wrench	Screw	Wrench	Screw	Wrench	Screw	Wrench
107.00 - 117.99	CSTB-4M	T-15D	CSTB-3.5D	T-9D	CSTB-3.5D	T-9D	CSTB-3.5D	T-9D	CSTB-4M	T-15D
118.00 - 135.99	CSTB-4M	T-15D	CSTB-4M	T-15D	CSTB-4M	T-15D	CSTB-4M	T-15D	CSTB-4M	T-15D
136.00 - 144.99	CSTB-4M	T-15D	CSTB-4M	T-15D	CSTB-4M	T-15D	CSTB-4M	T-15D	CSTB-5	T-20D
145.00 - 150.99	CSTB-4M	T-15D	CSTB-4M	T-15D	CSTB-5	T-20D	CSTB-4M	T-15D	CSTB-5	T-20D
151.00 - 156.99	CSTB-5	T-20D	CSTB-4M	T-15D	CSTB-5	T-20D	CSTB-4M	T-15D	CSTB-5	T-20D
157.00 - 162.99	CSTB-5	T-20D	CSTB-4M	T-15D	CSTB-5	T-20D	CSTB-5	T-20D	CSTB-5	T-20D
163.00 - 168.99	CSTB-5	T-20D	CSTB-5	T-20D	CSTB-5	T-20D	CSTB-5	T-20D	CSTB-5	T-20D

### SCREWS, WRENCHES (CICT = 5)

Tool diameter DCN-DCX (mm)	Cartridge screw								Guide pad screw			
	Peripheral				Intermediate		Central		Guide pad / Filler / Protector		Sub guide pad	
	Cartridge ①		Cartridge ② - ④		Cartridge ⑤							
	Screw	Wrench	Adj. screw	Wrench	Screw	Wrench	Screw	Wrench	Screw	Wrench	Screw	Wrench
107.00 - 117.99	LS1806RH	H4	AS0005-15	H2.5	CSTA-5	T-15D	LS1206	H3	LS1206S	H3	CSTA-5S	T-15D
118.00 - 135.99	LS1806RH	H4	AS0005-15	H2.5	LS1206	H3	LS1206	H3	LS1206SSS	H3	CSTA-5S	T-15D
136.00 - 144.99	LS1806RH	H4	AS0005-15	H2.5	LS1206	H3	LS1206S	H3	LS1206SSS	H3	CSTA-5S	T-15D
145.00 - 150.99	LS1806RH	H4	AS0005-15	H2.5	LS1206	H3	LS1206S	H3	LS1206SSS	H3	CSTA-5S	T-15D
151.00 - 156.99	LS1806RH	H4	AS0006-15	H3	LS1206	H3L	LS1206S	H3L	LS1206S	H3	CSTA-5S	T-15D
157.00 - 162.99	LS1806RH	H4	AS0006-15	H3	LS1206	H3L	LS1206S	H3L	LS1206S	H3	CSTA-5S	T-15D
163.00 - 168.99	LS1806RH	H4	AS0006-15	H3	LS1206	H3L	LS1206S	H3L	LS1206S	H3	CSTA-5S	T-15D

Recommended clamping torque: please see page J166.

Indexable drill head with external 4-start thread for double tube system (DTS), diameters adjustable, tool diameter  $\varnothing 169.00 - \varnothing 183.99$  mm ( $\varnothing 6.654'' - \varnothing 7.244''$ ), CICT = 7

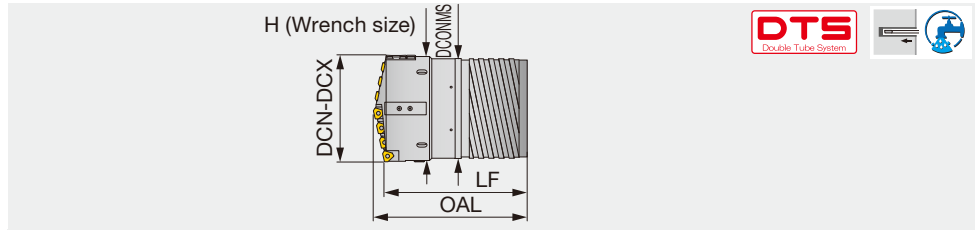

## Non-standard products (to be supplied on request)

When ordering

<b>KUDTS**E</b>	-	<b>XX.XX</b>
Drill head		Diameter (mm)

e.g. Designation for tool diameter  $\varnothing 170$  mm: **KUDTS24E-170.00**

Metric	DCN		DCX		CICT	Outer tube			Drill head		
	(in)	(mm)	(in)	(mm)		Designation	Dia. (mm)	OAL	LF	DCONMS	H
KUDTS24E-xx.xx	6.654	169	6.771	171.99	7	OT24	154	246	225	149	167
KUDTS25E-xx.xx	6.772	172	7.244	183.99	7	OT25	166	247	225	161	179

Before drilling operation, please adjust drill diameter. For diameter adjustment please see page **L109**.

### INSERTS

Tool diameter DCN-DCX (mm)	Peripheral insert	Qty	Intermediate insert	Qty	Central insert	Qty
169.00 - 183.99	TPMX24**R...	1	TPMX24**R...	5	TPMX24**R...	1

⊕ **Plus:** The drill diameter can be increased by up to 5 mm by using the Plus parts. A maximum expandable diameter is determined by the peripheral cartridge size used on the drill. See page **J167** for details. Drill heads come with cartridge, guide pad, filler, protector, sub guide pad and wrench, but do not include inserts.

### SPARE PARTS

Tool diameter DCN-DCX (mm)	Cartridge						
	Peripheral Cartridge ①	Cartridge ②	Cartridge ③	Cartridge ④	Cartridge ⑤	Cartridge ⑥	Central Cartridge ⑦
169.00 - 183.99	OZ402 - 43	IOZ402 - 43	IOZ402 - 43	IOZ402 - 43	IOZ402 - 43	IOZ402 - 43	IOZ402 - 43

### SPARE PARTS

Tool diameter DCN-DCX (mm)	Guide pad							
	Guide pad		Filler		Protector		Sub guide pad	
	⑧	Qty	⑨	Qty	⑩	Qty	⑪	Qty
169.00 - 183.99	GP18	4	FL18 - M	1	GPT18 - M	4	CUG14 - M	1

See page **L108** on handling of filler.

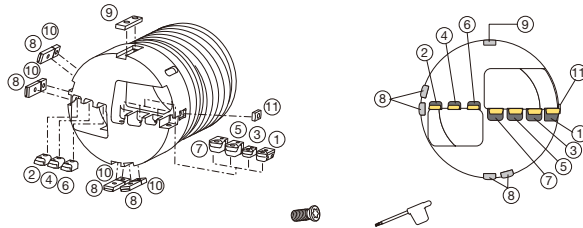

Part positions may vary depending on the drill size.

### SCREWS, WRENCHES (CICT = 7)

Tool diameter DCN-DCX (mm)	Insert screw													
	Peripheral Cartridge ①		Cartridge ②		Cartridge ③		Cartridge ④		Cartridge ⑤		Cartridge ⑥		Central Cartridge ⑦	
	Screw	Wrench	Screw	Wrench	Screw	Wrench	Screw	Wrench	Screw	Wrench	Screw	Wrench	Screw	Wrench
169.00 - 183.99	CSTB-4M	T-15D	CSTB-4M	T-15D	CSTB-4M	T-15D	CSTB-4M	T-15D	CSTB-4M	T-15D	CSTB-4M	T-15D	CSTB-4M	T-15D

### SCREWS, WRENCHES (CICT = 7)

Tool diameter DCN-DCX (mm)	Cartridge screw						Guide pad screw					
	Peripheral Cartridge ①		Intermediate Cartridge ② - ⑥		Central Cartridge ⑦		Guide pad / Filler / Protector		Sub guide pad			
	Screw	Wrench	Adj. screw	Wrench	Screw	Wrench	Screw	Wrench	Screw	Wrench		
169.00 - 183.99	LS1806RH	H4	AS0005-15	H2.5	LS1206	H3L	LS1206	H3L	LS1206SSS	H3	CSTA-5S	T-15D

Recommended clamping torque: please see page **J166**.

## STANDARD CUTTING CONDITIONS

See more information

e-catalog



Reference pages: Inserts → **J164**, Guide pads → **J165**, Drill tube (DTS) → **J178**

# INSERT

## NPMX\*\*R, TPMX\*\*R

NPMX type

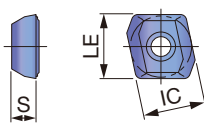

TPMX type

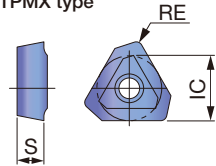

<b>P</b>	Steel	★	★	☆	☆								
<b>M</b>	Stainless	☆	★	☆	☆								
<b>K</b>	Cast iron	☆	★	☆	☆								
<b>N</b>	Non-ferrous	☆	★	☆	☆								
<b>S</b>	Superalloys	☆	☆	★	☆								
<b>H</b>	Hard materials	☆	☆	★	☆								

★ : First choice  
 ☆ : Second choice

Designation	HAND	Coated				IC (in)	S (in)	RE (in)	LE (in)
		T9225	AH9130	AH8015	UC2220				
NPMX080308R-G	R	●	●	●	●	0.315	0.125	-	0.329
NPMX080304R-B	R				●	0.315	0.125	-	0.329
TPMX140308R-G	R	●	●	●	●	0.333	0.138	0.0315	-
TPMX140304R-B	R				●	0.333	0.138	0.0157	-
TPMX140308R-B	R		●	●		0.333	0.138	0.0315	-
TPMX140308R-DT	R		●		●	0.333	0.138	0.0315	-
TPMX170408R-G	R	●	●	●	●	0.406	0.157	0.0315	-
TPMX170404R-B	R				●	0.406	0.157	0.0157	-
TPMX170408R-B	R		●	●		0.406	0.157	0.0315	-
TPMX170408R-BG	R		●	●	●	0.406	0.157	0.0315	-
TPMX170408R-DT	R		●		●	0.406	0.157	0.0315	-
TPMX240512R-G	R	●	●	●	●	0.559	0.217	0.0472	-
TPMX240504R-B	R				●	0.559	0.217	0.0157	-
TPMX240512R-B	R		●	●		0.559	0.217	0.0472	-
TPMX240512R-BG	R		●	●	●	0.559	0.217	0.0472	-
TPMX240512R-DT	R		●		●	0.559	0.217	0.0472	-
TPMX280716R-G	R	●	●	●	●	0.669	0.295	0.063	-
TPMX280708R-B	R				●	0.669	0.295	0.063	-
TPMX280716R-B	R		●	●		0.669	0.295	0.063	-
TPMX280716R-BG	R		●	●	●	0.669	0.295	0.063	-
TPMX280716R-DT	R		●		●	0.669	0.295	0.063	-

● : Line up  
 Package quantity = 10 pcs.

### Chipbreaker

<p><b>G</b></p> <p>Versatile</p>	<p><b>B</b></p> <p>Provides good chip control in heat-resistant alloys</p>
<p><b>BG</b></p> <p>Provides good chip control in long-chipping steels</p>	<p><b>DT</b></p> <p>Reduced cutting force</p>

### Insert grade

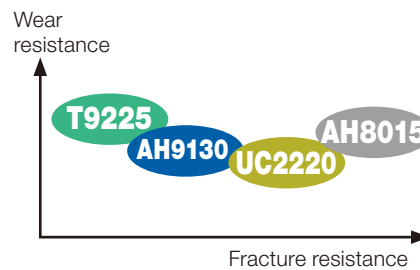

# GUIDE PAD

GP08, 10, 14, 18

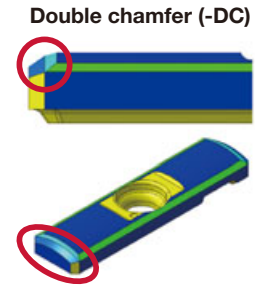
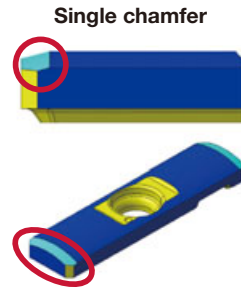
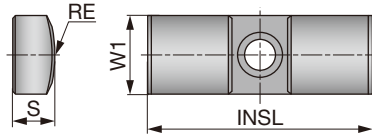

Designation	DCN (in)	DCX (in)	Coated			W1 (in)	INSL (in)	S (in)	RE (in)	Chamfer
			F1122	FH3125	FH3135					
GP08	1.496	1.771	●			0.315	0.984	0.177	0.610	Single
GP08-25-155-DC	1.496	1.771		●	●	0.315	0.984	0.177	0.610	Double
GP10	1.772	2.362	●			0.394	1.378	0.236	0.787	Single
GP10-35-200-DC	1.772	2.362		●	●	0.394	1.378	0.236	0.787	Double
GP14-40-250-DC	2.362	3.897		●	●	0.551	1.575	0.295	0.984	Double
GP18-40-300-DC	3.898	11.574		●	●	0.709	1.575	0.354	1.181	Double

●: Line up  
Package quantity = 5 pcs.

## Grade recommendations

ISO	Oil coolant			Water based coolant	
	First choice	Second choice	Third choice	First choice	Second choice
<b>P</b>	FH3125	F1122	FH3135	FH3135	FH3125
<b>M</b>	FH3135	FH3125	F1122	FH3135	FH3125
<b>K</b>	FH3125	F1122	FH3135	FH3135	FH3125
<b>N</b>	FH3125	F1122	FH3135	FH3135	FH3125
<b>S</b>	FH3135	FH3125	F1122	FH3135	FH3125
<b>H</b>	FH3135	FH3125	F1122	FH3135	FH3125

Grade  
Insert  
Toolholder  
Ext. Toolholder  
Int. Toolholder  
Threading  
Grooving  
Miniature tool  
Milling cutter  
Endmill  
Drilling tool  
Tooling System  
User's Guide  
Index



# Replacement parts

## Cartridges and inserts

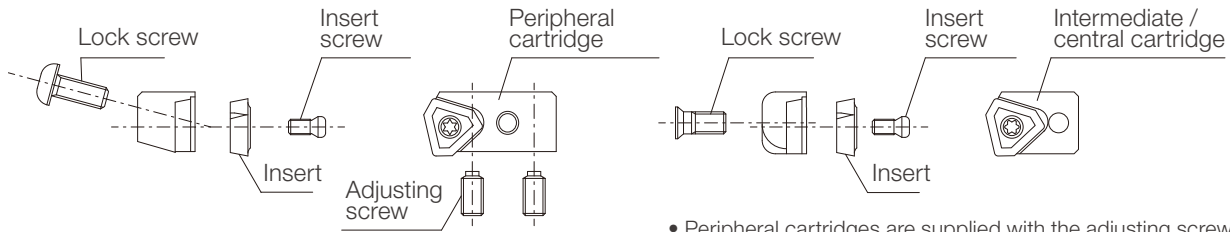

- Peripheral cartridges are supplied with the adjusting screws and insert screw (inserts, lock screw and wrenches are not included)
- Central and intermediate cartridges are supplied with insert screw (inserts, lock screw and wrenches are not included)

## Peripheral inserts and accessories

Cartridge	Insert	Insert screw	Wrench	Adjusting screw	Wrench	Lock screw	Wrench
OZ05R	NPMX080308R-G	CSTB-2.2	T-7D	AS0003-5	H1.5	LS1803RH	H2
OZ402-04	TPMX140308R-G	CSTB-2.5	T-8D	AS0004-8	H2	LS1803.5RH	H2.5
OZ402-32	TPMX170408R-G	CSTB-3.5D	T-9D	AS0005-10	H2.5	LS1805RH	H3
OZ402-43	TPMX240512R-G	CSTB-4M	T-15D	AS0005-15	H2.5	LS1806RH	H4
OZ402-63	TPMX280716R-G	CSTB-5	T-20D	AS0006-15	H3	LS1806RH	H4

## Central and intermediate inserts and accessories

Cartridge	Insert	Insert screw	Wrench	Lock screw	Wrench
IOZ05R	NPMX080308R-G	CSTB-2.2	T-7D	CSTB-3	T-9D
IOZ402-04	TPMX140308R-G	CSTB-2.5	T-8D	CSTB-3.5	T-15D
IOZ402-32	TPMX170408R-G	CSTB-3.5D	T-9D	CSTA-5	T-15D
IOZ402-43	TPMX240512R-G	CSTB-4M	T-15D	LS1206	H3 / H3L**
IOZ402-63	TPMX280716R-G	CSTB-5	T-20D	LS1206 / LS1206S*	H3 / H3L**

\*LS1206S for central cartridge

\*\*H3L for  $\phi 151.00$  mm -  $\phi 320.00$  mm

## Guide pads and protectors

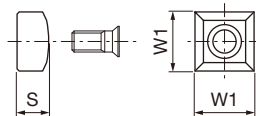

Guide pad	Dimensions (in)			Lock screw	Wrench	Protector	Dimensions (in)		Lock screw	Wrench
	W	H	L				W1	S		
GP08	0.315	0.177	0.984	CSTB-3S	T-9D	GPT08	0.315	0.177	CSTB-3S	T-9D
GP08-25-155-DC	0.315	0.177	0.984	CSTB-3S	T-9D	GPT08	0.315	0.177	CSTB-3S	T-9D
GP10	0.394	0.236	1.378	CSTB-4S	T-15D	GPT10	0.394	0.236	CSTB-4S	T-15D
GP10-35-200-DC	0.394	0.236	1.378	CSTB-4S	T-15D	GPT10	0.394	0.236	CSTB-4S	T-15D
GP14	0.551	0.295	1.575	CSTA-5S	T-15D	GPT14	0.551	0.295	CSTA-5S	T-15D
GP14-40-250-DC	0.551	0.295	1.575	CSTA-5S	T-15D	GPT14	0.551	0.295	CSTA-5S	T-15D
GP18	0.709	0.354	1.575	LS1206S / LS1206SSS ***	H3	GPT18-M	0.709	0.354	LS1206S	H3
GP18-40-300-DC	0.709	0.354	1.575	LS1206S / LS1206SSS ***	H3	GPT18-M	0.709	0.354	LS1206S	H3

\*\*\*LS1206SSS for dimensional guide pad

(for diameter  $\phi 118.00$  -  $\phi 150.99$ ,  $\phi 169.00$  -  $\phi 208.99$  and  $\phi 233.00$  -  $\phi 247.99$  mm)

## Recommended clamping torque

Screw	(lbs-ft)	(N-m)	Screw	(lbs-ft)	(N-m)	Screw	(lbs-ft)	(N-m)
CSTA-5	2.58	3.5	CSTB-3.5	2.58	3.5	LS1206S	2.21	3
CSTA-5S	2.58	3.5	CSTB-3.5D	1.70	2.3	LS1206SSS	2.21	3
CSTB-2.2	0.74	1	CSTB-4M	2.58	3.5	LS1803RH	1.62	2.2
CSTB-2.5	0.96	1.3	CSTB-4S	2.58	3.5	LS1803.5RH	1.62	2.2
CSTB-3	1.70	2.3	CSTB-5	3.69	5	LS1805RH	2.21	3
CSTB-3S	1.70	2.3	LS1206	2.21	3	LS1806RH	3.69	5



## Sub guide pad

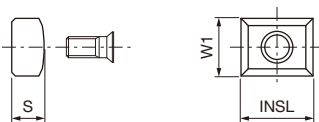

Guide pad	Dimensions (in)			Lock screw	Wrench
	W1	S	INSL		
CUG08	0.315	0.177	0.394	CSTB-3S	T-9D
CUG10	0.394	0.197	0.394	CSTB-3S	T-9D
CUG14-M	0.551	0.276	0.787	CSTA-5S	T-15D

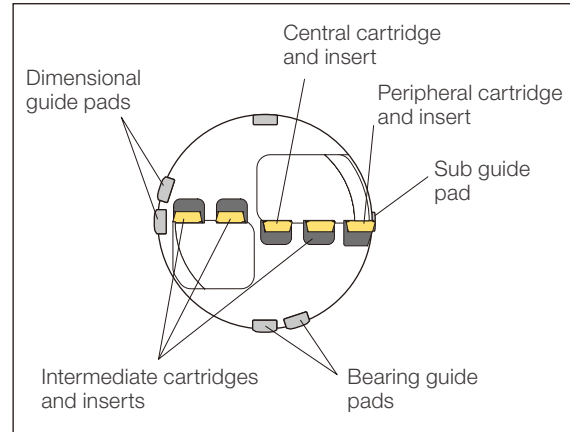

## Plus Plus parts

The use of the Plus parts allows the drill diameter to increase by up to 5 mm, in 1 mm increments. The diameter is increased by replacing the peripheral cartridges.

Ex. The drill head diameter with OZ402-32 peripheral cartridge can be increased by up to 4 mm, while the drill head diameter with OZ402-43 can be increased by up to 5 mm.

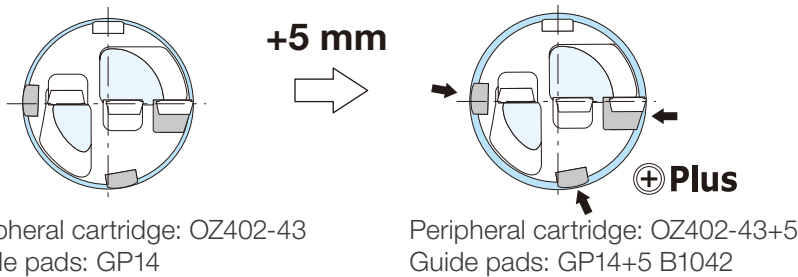

**Note:**  
When the peripheral cartridge is changed, the guide pads must also be changed to the matching Plus parts.

### Plus cartridge - OZ type

Plus	+1 mm		+2 mm		+3 mm		+4 mm		+5 mm	
	Part	Availability	Part	Availability	Part	Availability	Part	Availability	Part	Availability
OZ05R	OZ05R+1	○	OZ05R+2	○	-		-		-	
OZ402-04	OZ402-04+1	○	OZ402-04+2	○	OZ402-04+3	○	-		-	
OZ402-32	OZ402-32+1	○	OZ402-32+2	○	OZ402-32+3	○	OZ402-32+4	○	-	
OZ402-43	OZ402-43+1	○	OZ402-43+2	○	OZ402-43+3	○	OZ402-43+4	○	OZ402-43+5	○
OZ402-63	OZ402-63+1	○	OZ402-63+2	○	OZ402-63+3	○	OZ402-63+4	○	OZ402-63+5	○

Ordering example: OZ402-04+2, 1 pcs

### Plus cartridge - OX type

Plus	+1 mm		+2 mm		+3 mm		+4 mm		+5 mm	
	Part	Availability	Part	Availability	Part	Availability	Part	Availability	Part	Availability
OX04R	OX04R+1	○	OX04R+2	○	OX04R+3	○	-		-	
OX32R	OX32R+1	○	OX32R+2	○	OX32R+3	○	OX32R+4	○	-	
OX43R	OX43R+1	○	OX43R+2	○	OX43R+3	○	OX43R+4	○	OX43R+5	○
OX63R	OX63R+1	○	OX63R+2	○	OX63R+3	○	OX63R+4	○	OX63R+5	○

Ordering example: OX32R+2, 1 pcs

Use OX cartridges when using the UNIDEX series for boring operations. OX has a smaller entry angel than OZ, allowing better hole quality.

OX and OZ can be mounted in the same pocket for the peripheral cartridge.

### Plus guide pad

Plus	+1 mm		+2 mm		+3 mm		+4 mm		+5 mm	
	Part	Grade B1042	Part	Grade B1042	Part	Grade B1042	Part	Grade B1042	Part	Grade B1042
GP08	GP08+1	○	GP08+2	○	GP08+3	○	-		-	
GP10	GP10+1	○	GP10+2	○	GP10+3	○	GP10+4	○	-	
GP14	GP14+1	○	GP14+2	○	GP14+3	○	GP14+4	○	GP14+5	○
GP18	GP18+1	○	GP18+2	○	GP18+3	○	GP18+4	○	GP18+5	○

Ordering example: GP08+2 B1042, 5 pcs

○ : To be supplied on request

# MBU STS

## MBU type drill head

Brazed drill head with external single-start thread for single tube system (STS), tool diameter  $\varnothing 8 - \varnothing 14.79$  mm ( $\varnothing 0.315'' - \varnothing 0.582''$ ), CICT = 1

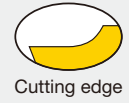
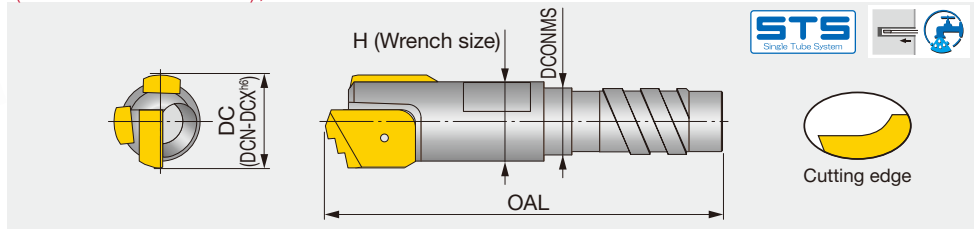

P	Steel	★	
M	Stainless	★	
K	Cast iron	★	
N	Non-ferrous	★	
S	Superalloys	★	
H	Hard materials	★	

★ : First choice  
☆ : Second choice

### Standard products

Metric	DC (in)	DC (mm)	Coated		Drill tube			H	
			1122	3112	Designation	Dia. (mm)	OAL		DCNMS
MBU-0999-2 9.40	0.370	9.4	●		UMBB083	8.3	34	7.2	7
MBU-1199-1 11.00	0.433	11	●		UMBB100	10	34	8.6	9

● : Line up

### Non-standard products (to be supplied on request)

When ordering

<b>MBU-0899-1</b>	<b>xx.xx</b>	<b>1122</b>
Drill head	Diameter (mm)	Grade

e.g. Designation for tool diameter  $\varnothing 9$  mm: MBU-0899-1 9.00 1122

Metric	DCN		DCX		Drill tube		OAL	DCNMS	H
	(in)	(mm)	(in)	(mm)	Designation	Dia. (mm)			
MBU-0899-1 xx.xx	0.315	8	0.328	8.32	UMBB071	7.1	34	6	6
MBU-0899-2 xx.xx	0.328	8.33	0.341	8.65	UMBB071	7.1	34	6	6
MBU-0899-3 xx.xx	0.341	8.66	0.354	8.99	UMBB071	7.1	34	6	6
MBU-0999-1 xx.xx	0.354	9	0.367	9.32	UMBB083	8.3	34	7.2	7
MBU-0999-2 xx.xx	0.367	9.33	0.380	9.65	UMBB083	8.3	34	7.2	7
MBU-0999-3 xx.xx	0.380	9.66	0.393	9.99	UMBB083	8.3	34	7.2	7
MBU-1099-1 xx.xx	0.394	10	0.406	10.32	UMBB090	9	34	7.6	8
MBU-1099-2 xx.xx	0.407	10.33	0.419	10.65	UMBB090	9	34	7.6	8
MBU-1099-3 xx.xx	0.420	10.66	0.433	10.99	UMBB090	9	34	7.6	8
MBU-1199-1 xx.xx	0.433	11	0.446	11.32	UMBB100	10	34	8.6	9
MBU-1199-2 xx.xx	0.446	11.33	0.459	11.65	UMBB100	10	34	8.6	9
MBU-1199-3 xx.xx	0.459	11.66	0.472	11.99	UMBB100	10	34	8.6	9
MBU-1349-1 xx.xx	0.472	12	0.487	12.36	UMBB110	11	34	9.1	10
MBU-1349-2 xx.xx	0.487	12.37	0.501	12.73	UMBB110	11	34	9.1	10
MBU-1349-3 xx.xx	0.502	12.74	0.516	13.1	UMBB110	11	34	9.1	10
MBU-1349-4 xx.xx	0.516	13.11	0.531	13.49	UMBB110	11	34	9.1	10
MBU-1449-1 xx.xx	0.531	13.5	0.544	13.82	UMBB120	12	34	10.8	11
MBU-1449-2 xx.xx	0.544	13.83	0.557	14.15	UMBB120	12	34	10.8	11
MBU-1449-3 xx.xx	0.557	14.16	0.570	14.48	UMBB120	12	34	10.8	11
MBU-1449-4 xx.xx	0.570	14.49	0.582	14.79	UMBB120	12	34	10.8	11

### STANDARD CUTTING CONDITIONS

See more information

e-catalog



Reference pages: Drill tube (STS) → **J174**

# UTE STS

## MBU type drill head

Brazed drill head with external 2-start or 4-start thread for single tube system (STS), tool diameter  $\varnothing 12.6 - \varnothing 20$  mm ( $\varnothing 0.496 - \varnothing 0.787$ " ), CICT = 1

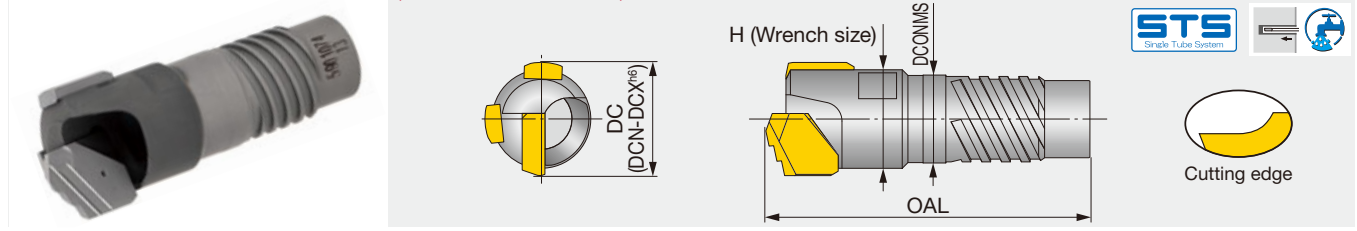

P	Steel	★
M	Stainless	
K	Cast iron	
N	Non-ferrous	
S	Superalloys	
H	Hard materials	

★ : First choice  
☆ : Second choice

### Standard products

Metric	DC (in)	DC (mm)	Coated		Drill tube				
			1122		Designation	Dia. (mm)	OAL	DCONMS	H
UTE-0094-1 12.90	0.496	12.9	●		ST0094	11	40	9.6	10

● : Line up

### Non-standard products (to be supplied on request)

When ordering

<b>UTE-0094-1</b>	<b>XX.XX</b>	<b>1122</b>
Drill head	Diameter (mm)	Grade

e.g. Designation for tool diameter  $\varnothing 12.92$  mm: UTE-0094-1 12.92 1122

Metric	DCN		DCX		Drill tube		OAL	DCONMS	H
	(in)	(mm)	(in)	(mm)	Designation	Dia. (mm)			
UTE-0094-1 xx.xx	0.496	12.6	0.509	12.92	ST0094	11	40	9.6	10
UTE-0094-2 xx.xx	0.509	12.93	0.511	12.99	ST0094	11	40	9.6	10
UTE-0094-3 xx.xx	0.512	13	0.522	13.25	ST0094	11	40	9.6	10
UTE-0094-4 xx.xx	0.522	13.26	0.535	13.6	ST0094	11	40	9.6	10
UTE-0095-1 xx.xx	0.536	13.61	0.548	13.93	ST0095	12	40	10.6	11
UTE-0095-2 xx.xx	0.549	13.94	0.551	13.99	ST0095	12	40	10.6	11
UTE-0095-3 xx.xx	0.551	14	0.561	14.26	ST0095	12	40	10.6	11
UTE-0095-4 xx.xx	0.562	14.27	0.575	14.6	ST0095	12	40	10.6	11
UTE-0096-1 xx.xx	0.575	14.61	0.588	14.93	ST0096	13	40	11.6	12
UTE-0096-2 xx.xx	0.588	14.94	0.601	15.26	ST0096	13	40	11.6	12
UTE-0096-3 xx.xx	0.601	15.27	0.614	15.59	ST0096	13	40	11.6	12
UTE-0097-1 xx.xx	0.614	15.6	0.628	15.96	ST0097	14	40	12.6	13
UTE-0097-2 xx.xx	0.629	15.97	0.643	16.32	ST0097	14	40	12.6	13
UTE-0097-3 xx.xx	0.643	16.33	0.657	16.7	ST0097	14	40	12.6	13
UTE-0098-1 xx.xx	0.658	16.71	0.670	17.03	ST0098	15	40	13.6	14
UTE-0098-2 xx.xx	0.671	17.04	0.683	17.36	ST0098	15	40	13.6	14
UTE-0098-3 xx.xx	0.684	17.37	0.697	17.7	ST0098	15	40	13.6	14
UTE-0099-1 xx.xx	0.697	17.71	0.712	18.09	ST0099	16	40	14.5	15
UTE-0099-2 xx.xx	0.713	18.1	0.728	18.48	ST0099	16	40	14.5	15
UTE-0099-3 xx.xx	0.728	18.49	0.744	18.9	ST0099	16	40	14.5	15
UTE-0000-1 xx.xx	0.744	18.91	0.758	19.26	ST0000	17	40	15.5	16
UTE-0000-2 xx.xx	0.759	19.27	0.772	19.62	ST0099	17	40	15.5	16
UTE-0000-3 xx.xx	0.773	19.63	0.787	20	ST0099	17	40	15.5	16

UTE Drill head :  $\varnothing 12.6$  mm -  $\varnothing 15.59$  mm, External 2-start thread

UTE Drill head :  $\varnothing 15.6$  mm -  $\varnothing 20$  mm, External 4-start thread

### STANDARD CUTTING CONDITIONS

See more information

e-catalog



Reference pages: Drill tube (STS) → **J174**



# BTU STS

## BTU type drill head (Small diameter, 2 edges)

Brazed drill head with external 2-start thread for single tube system (STS), tool diameter  $\varnothing 12.6 - \varnothing 15.59$  mm, CICT = 2

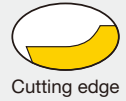
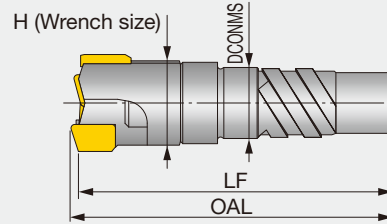
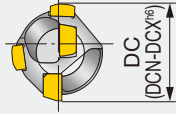

**Non-standard products (to be supplied on request)**

When ordering

**BTU-00941**

Drill head

**XX.XX**

Diameter (mm)

**1122**

Grade

e.g. Designation for tool diameter  $\varnothing 13.1$  mm: **BTU-00941 13.10 1122**

Metric	DCN		DCX		Drill tube		OAL	LF	DCONMS	H
	(in)	(mm)	(in)	(mm)	Designation	Dia. (mm)				
BTU-00941 xx.xx	0.496	12.6	0.516	13.1	ST0094	11	43	41.9	9.6	10
BTU-00942 xx.xx	0.516	13.11	0.535	13.6	ST0094	11	43	41.9	9.6	10
BTU-00951 xx.xx	0.536	13.61	0.555	14.1	ST0095	12	43	41.8	10.6	11
BTU-00952 xx.xx	0.556	14.11	0.575	14.6	ST0095	12	43	41.8	10.6	11
BTU-00961 xx.xx	0.575	14.61	0.594	15.1	ST0096	13	43	41.7	11.6	12
BTU-00962 xx.xx	0.595	15.11	0.614	15.59	ST0096	13	43	41.7	11.6	12

## STANDARD CUTTING CONDITIONS

See more information

e-catalog



Reference pages: Drill tube (STS) → **J174**

## BTU type drill head (2 edges)

Brazed drill head with external 4-start thread for single tube system (STS),  
tool diameter  $\varnothing 15.6 - \varnothing 65$  mm ( $\varnothing 0.634'' - \varnothing 1.039''$ ), CICT = 3

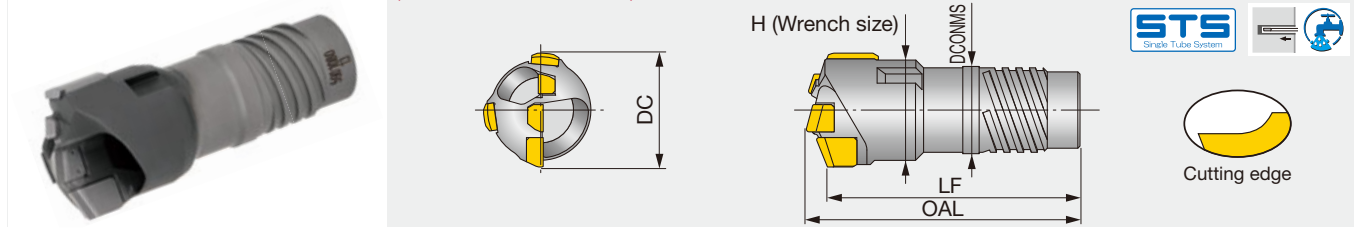

P	Steel	★				
M	Stainless	★	★			
K	Cast iron			★		
N	Non-ferrous				★	
S	Superalloys					★
H	Hard materials					★

★ : First choice  
☆ : Second choice

### Standard products

Metric	DC (in)	DC (mm)	Coated			Drill tube					
			1132	2122	3132	Designation	Dia. (mm)	OAL	LF	DCONMS	H
BTU-00971 16.11	0.634	16.11	●			ST0097	14	43	40.3	12.6	-
BTU-00971 16.13	0.635	16.13	●			ST0097	14	43	40.3	12.6	-
BTU-002 19.26	0.758	19.26		●		ST0000	17	47	44	15.5	18
BTU-002 19.27	0.759	19.27	●			ST0000	17	47	44	15.5	18
BTU-002 19.28	0.759	19.28	●			ST0000	17	47	44	15.5	18
BTU-002 19.3	0.760	19.3	●			ST0000	17	47	44	15.5	18
BTU-011 20.21	0.796	20.21	●			ST00	18	52.5	49.4	16	18
BTU-011 20.28	0.798	20.28	●			ST00	18	52.5	49.4	16	18
BTU-021 22.1	0.870	22.1		●		ST01	20	56	52.8	18	20
BTU-022 23.6	0.929	23.6		●		ST01	20	56	52.6	18	21
BTU-032 25.26	0.994	25.26	●			ST02	22	57.5	54	19.5	24
BTU-032 25.28	0.995	25.28	●			ST02	22	57.5	54	19.5	24
BTU-032 25.66	1.010	25.66	●			ST02	22	57.5	54	19.5	24
BTU-032 25.67	1.011	25.67	●			ST02	22	57.5	54	19.5	24
BTU-032 25.68	1.011	25.68	●			ST02	22	57.5	54	19.5	24
BTU-032 26.4	1.039	26.4		●		ST02	22	57.5	54	19.5	24

● : Line up

## STANDARD CUTTING CONDITIONS

See more information

e-catalog



# BTU STS

## BTU type drill head (3 edges)

Brazed drill head with external 4-start thread for single tube system (STS), tool diameter  $\varnothing 15.6 - \varnothing 65$  mm ( $\varnothing 0.614" - \varnothing 2.559"$ ), CICT = 3

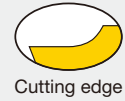
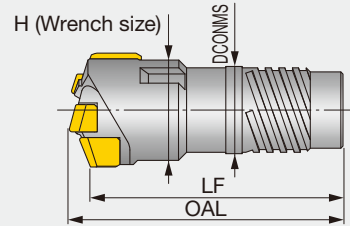
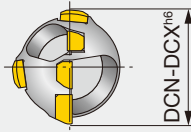

### Non-standard products (to be supplied on request)

When ordering

<b>BTU-00971</b>	<b>xx.xx</b>	<b>1122</b>
Drill head	Diameter (mm)	Grade

e.g. Designation for tool diameter  $\varnothing 16.2$  mm: **BTU-00971 16.20 1122**

Metric	DCN		DCX		Drill tube		OAL	LF	DCONMS	H
	(in)	(mm)	(in)	(mm)	Designation	Dia. (mm)				
BTU-00971 xx.xx	0.614	15.6	0.638	16.2	ST0097	14	43	40.3	12.6	-
BTU-00972 xx.xx	0.638	16.21	0.657	16.7	ST0097	14	43	40.3	12.6	14
BTU-00981 xx.xx	0.658	16.71	0.677	17.2	ST0098	15	43	40.3	13.6	15
BTU-00982 xx.xx	0.678	17.21	0.697	17.7	ST0098	15	43	40.3	13.6	15
BTU-00991 xx.xx	0.697	17.71	0.724	18.4	ST0099	16	47	44.2	14.5	15
BTU-00992 xx.xx	0.725	18.41	0.744	18.9	ST0099	16	47	44.1	14.5	-
BTU-001 xx.xx	0.744	18.91	0.756	19.2	ST0000	17	47	44.1	15.5	17
BTU-002 xx.xx	0.756	19.21	0.787	20	ST0000	17	47	44	15.5	18
BTU-011 xx.xx	0.788	20.01	0.823	20.9	ST00	18	52.5	49.4	16	18
BTU-012 xx.xx	0.823	20.91	0.858	21.8	ST00	18	52.5	49.4	16	19
BTU-021 xx.xx	0.859	21.81	0.902	22.9	ST01	20	56	52.8	18	20
BTU-022 xx.xx	0.902	22.91	0.949	24.1	ST01	20	56	52.6	18	21
BTU-031 xx.xx	0.949	24.11	0.992	25.2	ST02	22	57.5	54	19.5	23
BTU-032 xx.xx	0.993	25.21	1.039	26.4	ST02	22	57.5	54	19.5	24
BTU-041 xx.xx	1.040	26.41	1.083	27.5	ST03	24	57.5	53.8	21	25
BTU-042 xx.xx	1.083	27.51	1.130	28.7	ST03	24	57.5	53.8	21	26
BTU-051 xx.xx	1.130	28.71	1.173	29.8	ST04	26	63.5	59.5	23.5	27
BTU-052 xx.xx	1.174	29.81	1.220	31	ST04	26	63.5	59.3	23.5	28
BTU-061 xx.xx	1.221	31.01	1.264	32.1	ST05	28	63.5	59.4	25.5	29
BTU-062 xx.xx	1.264	32.11	1.311	33.3	ST05	28	63.5	59.1	25.5	30
BTU-071 xx.xx	1.311	33.31	1.370	34.8	ST06	30	63.5	59	28	32
BTU-072 xx.xx	1.370	34.81	1.425	36.2	ST06	30	63.5	58.9	28	33
BTU-081 xx.xx	1.426	36.21	1.469	37.3	ST07	33	73.5	68.7	30	34
BTU-082 xx.xx	1.469	37.31	1.512	38.4	ST07	33	73.5	68.5	30	35
BTU-083 xx.xx	1.512	38.41	1.559	39.6	ST07	33	73.5	68.3	30	36
BTU-091 xx.xx	1.559	39.61	1.598	40.6	ST08	36	73.5	68.2	33	37
BTU-092 xx.xx	1.599	40.61	1.646	41.8	ST08	36	73.5	68	33	38
BTU-093 xx.xx	1.646	41.81	1.693	43	ST08	36	73.5	67.8	33	39
BTU-101 xx.xx	1.693	43.01	1.744	44.3	ST09	39	75	69.5	36	41
BTU-102 xx.xx	1.744	44.31	1.795	45.6	ST09	39	75	69.3	36	42
BTU-103 xx.xx	1.796	45.61	1.850	47	ST09	39	75	69.1	36	43
BTU-111 xx.xx	1.851	47.01	1.909	48.5	ST10	43	75	68.8	39	44
BTU-112 xx.xx	1.910	48.51	1.972	50.1	ST10	43	75	68.7	39	46
BTU-113 xx.xx	1.973	50.11	2.035	51.7	ST10	43	75	68.5	39	47
BTU-121 xx.xx	2.036	51.71	2.094	53.2	ST11	47	82	75.2	43	49
BTU-122 xx.xx	2.095	53.21	2.154	54.7	ST11	47	82	75.2	43	50
BTU-123 xx.xx	2.154	54.71	2.213	56.2	ST11	47	82	75.2	43	51
BTU-131 xx.xx	2.213	56.21	2.299	58.4	ST12	51	84	77.4	47	54
BTU-132 xx.xx	2.300	58.41	2.386	60.6	ST12	51	84	76.9	47	55
BTU-133 xx.xx	2.386	60.61	2.472	62.8	ST12	51	84	76.8	47	57
BTU-134 xx.xx	2.473	62.81	2.559	65	ST12	51	84	76.5	47	59
BTU-133L xx.xx	2.386	60.61	2.472	62.8	ST13	56	84	76.8	51	57
BTU-134L xx.xx	2.473	62.81	2.559	65	ST13	56	84	76.5	51	59

### STANDARD CUTTING CONDITIONS

See more information

e-catalog



Reference pages: Drill tube (STS) → **J174**



# ETU DTS

## ETU type drill head

Brazed drill head with external 4-start thread for double tube system (DTS), tool diameter  $\varnothing 18.4 - \varnothing 65$  mm, CICT = 3

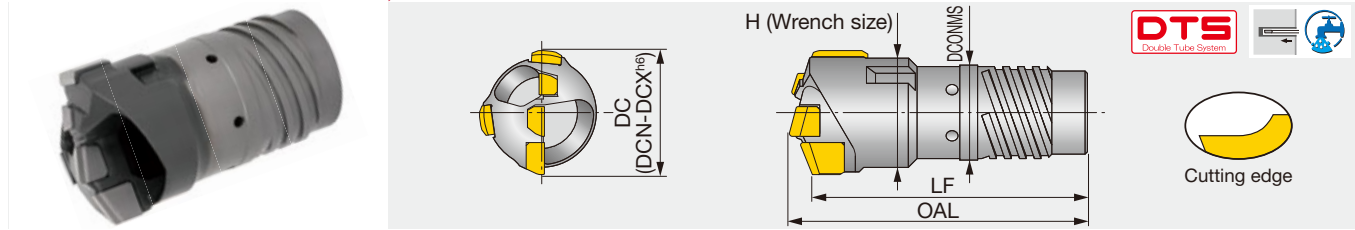

**Non-standard products (to be supplied on request)**

When ordering

<b>ETU-001</b>	<b>XX.XX</b>	<b>1122</b>
Drill head	Diameter (mm)	Grade

e.g. Designation for tool diameter  $\varnothing 19.2$  mm: **ETU-001 19.20 1122**

Metric	DCN		DCX		Drill tube		OAL	LF	DCONMS	H
	(in)	(mm)	(in)	(mm)	Designation	Dia. (mm)				
ETU-001 xx.xx	0.724	18.4	0.756	19.2	OT00	18	50	47.1	16	17
ETU-002 xx.xx	0.756	19.21	0.787	20	OT00	18	50	47	16	18
ETU-011 xx.xx	0.788	20.01	0.823	20.9	OT01	20	56	52.8	18	18
ETU-012 xx.xx	0.823	20.91	0.858	21.8	OT01	20	56	52.7	18	19
ETU-021 xx.xx	0.859	21.81	0.902	22.9	OT02	22	56	52.8	19.5	20
ETU-022 xx.xx	0.902	22.91	0.949	24.1	OT02	22	56	52.6	19.5	21
ETU-031 xx.xx	0.949	24.11	0.992	25.2	OT03	24	57.5	54	21	23
ETU-032 xx.xx	0.993	25.21	1.039	26.4	OT03	24	57.5	54	21	24
ETU-041 xx.xx	1.040	26.41	1.083	27.5	OT04	26	60.5	56.8	23.5	25
ETU-042 xx.xx	1.083	27.51	1.130	28.7	OT04	26	60.5	56.8	23.5	26
ETU-051 xx.xx	1.130	28.71	1.173	29.8	OT05	28	63.5	59.5	25.5	27
ETU-052 xx.xx	1.174	29.81	1.220	31	OT05	28	63.5	59.3	25.5	28
ETU-061 xx.xx	1.221	31.01	1.264	32.1	OT06	31	63.5	59.4	28	29
ETU-062 xx.xx	1.264	32.11	1.311	33.3	OT06	31	63.5	59.2	28	30
ETU-071 xx.xx	1.311	33.31	1.370	34.8	OT07	33	70.5	66	30	32
ETU-072 xx.xx	1.370	34.81	1.425	36.2	OT07	33	70.5	65.8	30	33
ETU-081 xx.xx	1.426	36.21	1.469	37.3	OT08	36	73.5	68.7	33	34
ETU-082 xx.xx	1.469	37.31	1.512	38.4	OT08	36	73.5	68.5	33	35
ETU-083 xx.xx	1.512	38.41	1.559	39.6	OT08	36	73.5	68.3	33	36
ETU-091 xx.xx	1.559	39.61	1.598	40.6	OT09	39	73.5	68.2	36	37
ETU-092 xx.xx	1.599	40.61	1.646	41.8	OT09	39	73.5	68	36	38
ETU-093 xx.xx	1.646	41.81	1.693	43	OT09	39	73.5	67.9	36	39
ETU-101 xx.xx	1.693	43.01	1.744	44.3	OT10	43	75	69.5	39	41
ETU-102 xx.xx	1.744	44.31	1.795	45.6	OT10	43	75	69.3	39	42
ETU-103 xx.xx	1.796	45.61	1.850	47	OT10	43	75	69.1	39	43
ETU-111 xx.xx	1.851	47.01	1.909	48.5	OT11	47	79	72.9	43	44
ETU-112 xx.xx	1.910	48.51	1.972	50.1	OT11	47	79	72.8	43	46
ETU-113 xx.xx	1.973	50.11	2.035	51.7	OT11	47	79	72.5	43	47
ETU-121 xx.xx	2.036	51.71	2.094	53.2	OT12	51	82	75.3	47	49
ETU-122 xx.xx	2.095	53.21	2.154	54.7	OT12	51	82	75.5	47	50
ETU-123 xx.xx	2.154	54.71	2.213	56.2	OT12	51	82	75.3	47	51
ETU-131 xx.xx	2.213	56.21	2.299	58.4	OT13	56	84	77.4	51	54
ETU-132 xx.xx	2.300	58.41	2.386	60.6	OT13	56	84	76.9	51	55
ETU-133 xx.xx	2.386	60.61	2.472	62.8	OT13	56	84	77	51	57
ETU-134 xx.xx	2.473	62.81	2.559	65	OT13	56	84	76.6	51	59

## STANDARD CUTTING CONDITIONS

See more information

e-catalog



Reference pages: Drill tube (DTS) → **J178**

# ST STS

## ST - for single tube system

Drill tube for single tube system (STS), internal thread type, 2-start thread (tool dia. ≤ ø15.59 mm) or 4-start thread (tool dia. ≥ ø15.6 mm)

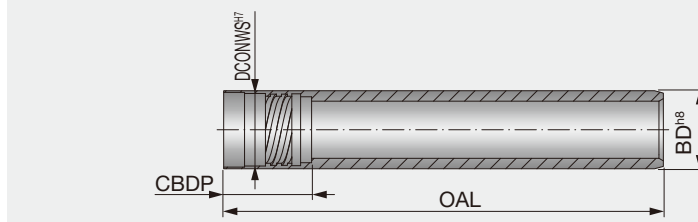

Metric	DCN-DCX		OAL		BD	DCONWS	CBDP	Metric	DCN-DCX		OAL	BD	DCONWS	CBDP
	(in)	(mm)	1600	2600					(in)	(mm)				
ST0094	0.496 - 0.535	12.6 - 13.6	●	○	11	9.6	22	ST14	2.559 - 2.637	65 - 66.99	○	56	52	75
ST0095	0.536 - 0.575	13.61 - 14.6	●	○	12	10.6	22	ST15	2.638 - 2.874	67 - 72.99	○	62	58	75
ST0096	0.575 - 0.614	14.61 - 15.59	●	○	13	11.6	22	ST16	2.874 - 3.149	73 - 79.99	○	68	63	75
ST0097	0.614 - 0.657	15.6 - 16.7	●	○	14	12.6	21	ST17	3.15 - 3.425	80 - 86.99	○	75	70	97
ST0098	0.658 - 0.697	16.71 - 17.7	●	●	15	13.6	21	ST18	3.425 - 3.937	87 - 99.99	○	82	77	97
ST0099	0.697 - 0.744	17.71 - 18.9	●	●	16	14.5	22	ST19	3.937 - 4.409	100 - 111.99	○	94	89	97
ST0000	0.744 - 0.787	18.91 - 20	●	●	17	15.5	22	ST20	4.409 - 4.881	112 - 123.99	○	106	101	118
ST00	0.788 - 0.858	20.01 - 21.8	●	●	18	16	27.5	ST21	4.882 - 5.354	124 - 135.99	○	118	113	118
ST01	0.859 - 0.949	21.81 - 24.1	●	○	20	18	30	ST22	5.354 - 5.826	136 - 147.99	○	130	125	118
ST02	0.949 - 1.039	24.11 - 26.4	●	○	22	19.5	30	ST23	5.827 - 6.299	148 - 159.99	○	142	137	139
ST03	1.040 - 1.130	26.41 - 28.7	●	○	24	21	30	ST24	6.299 - 6.771	160 - 171.99	○	154	149	139
ST04	1.130 - 1.220	28.71 - 31	●	○	26	23.5	33	ST25	6.772 - 7.244	172 - 183.99	○	166	161	139
ST05	1.221 - 1.311	31.01 - 33.3	●	○	28	25.5	33	ST26	7.244 - 7.716	184 - 195.99	○	178	173	144
ST06	1.311 - 1.425	33.31 - 36.2	●	○	30	28	33	ST27	7.717 - 8.189	196 - 207.99	○	190	185	144
ST07	1.426 - 1.559	36.21 - 39.6	●	○	33	30	40	ST28	8.189 - 8.661	208 - 219.99	○	202	197	144
ST08	1.559 - 1.693	39.61 - 43	●	○	36	33	40	ST29	8.661 - 9.133	220 - 231.99	○	214	208	164
ST09	1.693 - 1.850	43.01 - 47	●	○	39	36	40	ST30	9.134 - 9.606	232 - 243.99	○	226	220	164
ST10	1.851 - 2.035	47.01 - 51.7	●	○	43	39	40	ST31	9.606 - 10.078	244 - 255.99	○	238	232	164
ST11	2.036 - 2.213	51.71 - 56.2	●	○	47	43	44	ST32	10.079 - 10.551	256 - 267.99	○	250	244	184
ST12	2.213 - 2.386	56.21 - 60.6	●	○	51	47	44	ST33	10.551 - 11.023	268 - 279.99	○	262	256	184
ST13	2.386 - 2.559	60.61 - 65	○	○	56	51	44	ST34	11.024 - 11.496	280 - 291.99	○	274	268	184

Please specify the length (OAL) when ordering.  
e.g. For ø60 mm drill diameter / 2600 mm drill tube length: ST12X2600  
The lengths that are not in the above will be available upon request.

● : Line up  
○ : Item to be customized

# UMBB STS

## UMBB - for single tube system with MBU

Drill tube with internal single-start thread for MBU drill head

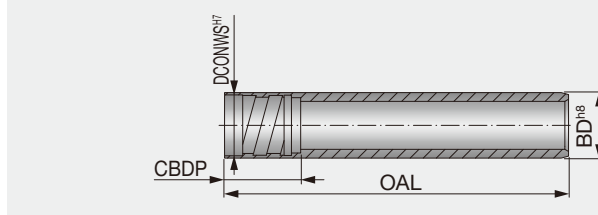

Metric	DCN-DCX		OAL	BD	DCONWS	CBDP
	(in)	(mm)				
UMBB071	0.315 - 0.354	8 - 8.99	○	7.1	6	13.5
UMBB083	0.354 - 0.393	9 - 9.99	○	8.3	7.2	13.5
UMBB090	0.394 - 0.433	10 - 10.99	○	9	7.6	13.5
UMBB100	0.433 - 0.472	11 - 11.99	○	10	8.6	13.5
UMBB110	0.472 - 0.531	12 - 13.49	○	11	9.1	13.5
UMBB120	0.531 - 0.582	13.5 - 14.79	○	12	10.8	13.5

Please specify the length (OAL) when ordering.  
e.g. For ø11 mm drill diameter / 1000 mm drill tube length: UMBB100X1000

○ : Item to be customized

Reference pages: ST: Drill head → **J134** (TRI-FINE STS-EX), **J139** (FINE-BEAM STS-EX), **J147** - (UNIDEX STS-EX), **J169** (UTE), **J170** - (BTU)  
UMBB: Drill head → **J168** (MBU)

## Tube length for special drills

Drill tubes with non-standard lengths will be available upon request. Please use the guide below to calculate the drill tube length.

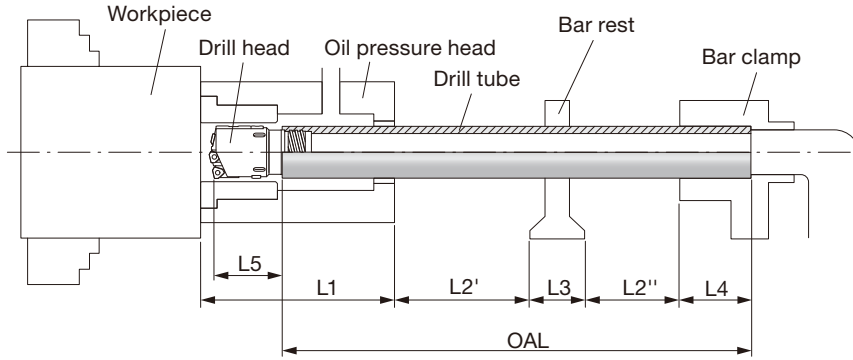

OAL = Drill tube overall length  
 L1 = Oil pressure head length  
 L2 = Drilling depth (L2' + L2'')  
 L3 = Bar rest length  
 L4 = Drill tube clamp length  
 L5 = Length from drill tube tip and peripheral edge tip

$$\text{Drill tube length OAL} \cong L1 + L2 + L3 + L4 - L5$$

### TRI-FINE



DCN-DCX		L5
(in)	(mm)	
0.630 - 0.657	16 - 16.7	34
0.658 - 0.697	16.71 - 17.7	34
0.697 - 0.744	17.71 - 18.9	34
0.744 - 0.787	18.91 - 20	34
0.788 - 0.858	20.01 - 21.8	32.5
0.859 - 0.866	21.81 - 21.99	33.5
0.866 - 0.949	22 - 24.1	35.5
0.949 - 1.039	24.11 - 26.4	35.5
1.040 - 1.102	26.41 - 28	35.5

### FINE-BEAM



DCN-DCX		L5
(in)	(mm)	
0.984 - 1.13	25 - 28.7	40
1.13 - 1.311	28.71 - 33.3	42
1.311 - 1.425	33.31 - 36.2	47
1.426 - 1.559	36.21 - 39.6	50
1.559 - 1.693	39.61 - 43	55
1.693 - 2.035	43.01 - 51.7	60
2.036 - 2.213	51.71 - 56.2	66
2.213 - 2.559	56.21 - 65	71

### UNIDEX



DCN-DCX		L5
(in)	(mm)	
1.496 - 1.693	38 - 43	45
1.693 - 2.035	43.01 - 51.7	55
2.036 - 2.213	51.71 - 56.2	56
2.213 - 2.559	56.21 - 65	66
2.559 - 3.149	65 - 79.99	75
3.15 - 4.409	80 - 111.99	83
4.409 - 5.826	112 - 147.99	87
5.827 - 7.244	148 - 183.99	86
7.244 - 10.078	184 - 255.99	101
10.079 - 11.496	256 - 291.99	106

### MBU



DCN-DCX		L5
(in)	(mm)	
0.315 - 0.328	8 - 8.32	18
0.328 - 0.341	8.33 - 8.65	18
0.341 - 0.354	8.66 - 8.99	18
0.354 - 0.367	9 - 9.32	18
0.367 - 0.380	9.33 - 9.65	18
0.380 - 0.393	9.66 - 9.99	18
0.394 - 0.406	10 - 10.32	18
0.407 - 0.419	10.33 - 10.65	18
0.420 - 0.433	10.66 - 10.99	18
0.433 - 0.446	11 - 11.32	18
0.446 - 0.459	11.33 - 11.65	18
0.459 - 0.472	11.66 - 11.99	18
0.472 - 0.487	12 - 12.36	18
0.487 - 0.501	12.37 - 12.73	18
0.502 - 0.516	12.74 - 13.1	18
0.516 - 0.531	13.11 - 13.49	18
0.531 - 0.544	13.5 - 13.82	18
0.544 - 0.557	13.83 - 14.15	18
0.557 - 0.570	14.16 - 14.48	18
0.570 - 0.582	14.49 - 14.79	18

### UTE



DCN-DCX		L5
(in)	(mm)	
0.496 - 0.509	12.6 - 12.92	19
0.509 - 0.511	12.93 - 12.99	19
0.512 - 0.522	13 - 13.25	19
0.522 - 0.535	13.26 - 13.6	19
0.536 - 0.548	13.61 - 13.93	19
0.549 - 0.551	13.94 - 13.99	19
0.551 - 0.561	14 - 14.26	19
0.562 - 0.575	14.27 - 14.6	19
0.575 - 0.588	14.61 - 14.93	19
0.588 - 0.601	14.94 - 15.26	19
0.601 - 0.614	15.27 - 15.59	19
0.614 - 0.628	15.6 - 15.96	20
0.629 - 0.643	15.97 - 16.32	20
0.643 - 0.657	16.33 - 16.7	20
0.658 - 0.67	16.71 - 17.03	20
0.671 - 0.683	17.04 - 17.36	20
0.684 - 0.697	17.37 - 17.7	20
0.697 - 0.712	17.71 - 18.09	19
0.713 - 0.728	18.1 - 18.48	19
0.728 - 0.744	18.49 - 18.9	19
0.744 - 0.758	18.91 - 19.26	19
0.759 - 0.772	19.27 - 19.62	19
0.773 - 0.787	19.63 - 20	19

### BTU



DCN-DCX		L5
(in)	(mm)	
0.496 - 0.697	12.6 - 17.7	20
0.697 - 0.756	17.71 - 19.2	23
0.756 - 0.858	19.21 - 21.8	22
0.859 - 0.949	21.81 - 24.1	23
0.949 - 1.13	24.11 - 28.7	24
1.13 - 1.311	28.71 - 33.3	27
1.311 - 1.425	33.31 - 36.2	26
1.426 - 1.598	36.21 - 40.6	29
1.599 - 1.693	40.61 - 43	28
1.693 - 1.85	43.01 - 47	30
1.851 - 2.035	47.01 - 51.7	29
2.036 - 2.213	51.71 - 56.2	32
2.213 - 2.299	56.21 - 58.4	34
2.3 - 2.559	58.41 - 65	33

# UB STS

## UB - for single tube system

Drill tube for single tube system (STS), external thread type, single-start thread

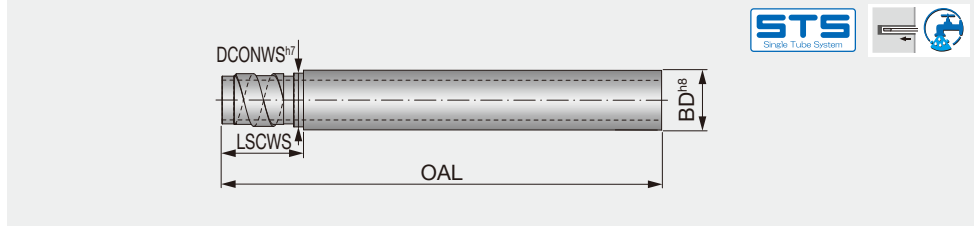

Metric	DCN - DCX		OAL Special length	BD	DCONWS	LSCWS	Metric	DCN - DCX		OAL Special length	BD	DCONWS	LSCWS
	(in)	(mm)						(in)	(mm)				
UB12-1	0.571 - 0.591	14.5 - 15	○	12	11.5	23	UB56	2.402 - 2.677	61 - 67.99	○	56	53	41
UB12-2	0.591 - 0.61	15.01 - 15.5	○	12	11.8	23	UB62	2.677 - 2.952	68 - 74.99	○	62	59	41
UB13-1	0.611 - 0.63	15.51 - 16	○	13	12.4	23	UB68	2.953 - 3.189	75 - 80.99	○	68	65	71
UB13-2	0.630 - 0.650	16.01 - 16.5	○	13	12.7	23	UB75	3.189 - 3.582	81 - 90.99	○	75	71	71
UB14-1	0.650 - 0.679	16.51 - 17.25	○	14	13.4	23	UB82	3.583 - 3.897	91 - 98.99	○	82	79	71
UB14-2	0.680 - 0.709	17.26 - 18	○	14	13.7	23	UB94	3.898 - 4.370	99 - 110.99	○	94	90	71
UB15	0.709 - 0.748	18.01 - 19	○	15	14.4	23	UB106	4.370 - 4.842	111 - 122.99	○	106	102	71
UB16.5	0.748 - 0.787	19.01 - 19.99	○	16.5	15.4	23	UB118	4.843 - 5.315	123 - 134.99	○	118	114	71
UB18	0.787 - 0.866	20 - 21.99	○	18	16.5	26	UB130	5.315 - 5.866	135 - 148.99	○	130	126	71
UB20	0.866 - 0.984	22 - 24.99	○	20	19	26	UB142	5.866 - 6.378	149 - 161.99	○	142	139	71
UB22	0.984 - 1.063	25 - 26.99	○	22	20	26	UB154	6.378 - 6.850	162 - 173.99	○	154	151	86
UB24	1.063 - 1.181	27 - 29.99	○	24	22	26	UB166	6.850 - 7.322	174 - 185.99	○	166	163	86
UB26	1.181 - 1.259	30 - 31.99	○	26	24	26	UB178	7.323 - 7.795	186 - 197.99	○	178	175	86
UB28	1.260 - 1.338	32 - 33.99	○	28	26	26	UB190	7.795 - 8.267	198 - 209.99	○	190	187	86
UB30	1.339 - 1.456	34 - 36.99	○	30	27	41	UB202	8.268 - 8.740	210 - 221.99	○	202	199	86
UB33	1.457 - 1.574	37 - 39.99	○	33	30	41	UB214	8.740 - 9.212	222 - 233.99	○	214	211	86
UB36	1.575 - 1.732	40 - 43.99	○	36	33	41	UB226	9.213 - 9.685	234 - 245.99	○	226	223	86
UB39	1.732 - 1.850	44 - 46.99	○	39	37	41	UB238	9.685 - 10.157	246 - 257.99	○	238	235	86
UB43	1.850 - 2.047	47 - 51.99	○	43	41	41	UB250	10.157 - 10.63	258 - 269.99	○	250	247	121
UB47	2.047 - 2.244	52 - 56.99	○	47	44	41	UB262	10.63 - 11.102	270 - 281.99	○	262	259	121
UB51	2.244 - 2.401	57 - 60.99	○	51	49	41	UB274	11.102 - 11.574	282 - 293.99	○	274	271	121

Please specify the length (OAL) when ordering.  
e.g. For ø60 mm drill diameter / 2600 mm drill tube length: UB51X2600

○ : Item to be customized

Reference pages: Drill head → **J135** (TRI-FINE STS-IN), **J140** (FINE-BEAM STS-IN), **J148** - (UNIDEX STS-IN)

## ■ Tube length for special drills

Please use the guide below to calculate the drill tube length.

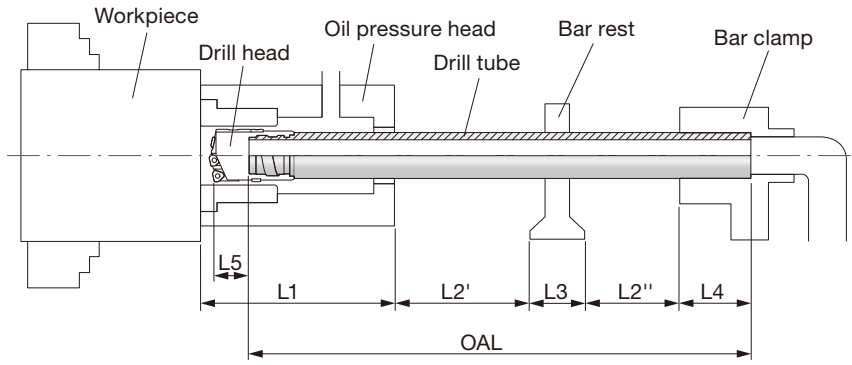

- OAL = Drill tube overall length
- L1 = Oil pressure head length
- L2 = Drilling depth (L2' + L2'')
- L3 = Bar rest length
- L4 = Drill tube clamp length
- L5 = Length from drill tube tip and peripheral edge tip

$$\text{Drill tube length OAL} = L1 + L2 + L3 + L4 - L5$$

### TRI-FINE



DCN - DCX		L5
(in)	(mm)	
0.63 - 0.65	16 - 16.5	31.5
0.65 - 0.679	16.51 - 17.25	31.5
0.68 - 0.709	17.26 - 18	31.5
0.709 - 0.748	18.01 - 19	31.5
0.748 - 0.787	19.01 - 19.99	31.5
0.787 - 0.866	20 - 21.99	33
0.866 - 0.984	22 - 24.99	35
0.984	25	35
0.985 - 1.063	25.01 - 26.99	40
1.063 - 1.102	27 - 28	40

### FINE-BEAM



DCN - DCX		L5
(in)	(mm)	
0.984 - 1.181	25 - 29.99	45
1.181 - 1.338	30 - 33.99	50
1.339 - 1.456	34 - 36.99	50
1.457 - 1.574	37 - 39.99	55
1.575 - 1.732	40 - 43.99	60
1.732 - 2.047	44 - 51.99	65
2.047 - 2.244	52 - 56.99	70
2.244 - 2.559	57 - 65	75

### UNIDEX



DCN - DCX		L5
(in)	(mm)	
1.496 - 1.732	38 - 43.99	40
1.732 - 2.047	44 - 51.99	50
2.047 - 2.244	52 - 56.99	60
2.244 - 2.677	57 - 67.99	70
2.677 - 6.378	68 - 161.99	80
6.378 - 10.157	162 - 257.99	105
10.157 - 11.574	258 - 293.99	90

Grade  
Insert  
Ext. Toolholder  
Int. Toolholder  
Threading  
Grooving  
Miniature tool  
Milling cutter  
Endmill  
Drilling tool  
Tooling System  
User's Guide  
Index

A  
B  
C  
D  
E  
F  
G  
H  
I  
J  
K  
L  
M

# OT & IT DTS

## OT & IT - for double tube system

Outer tube and inner tube for double tube system (DTS)

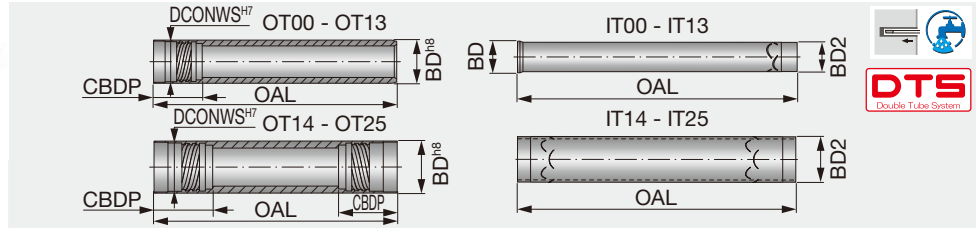

### Outer tube (OT)

### Inner tube (IT)

Metric	DCN - DCX		OAL Special length	BD	DCONWS	CBDP	Metric	DCN - DCX		OAL Special length	BD	BD2
	(in)	(mm)						(in)	(mm)			
OT00	0.724 - 0.787	18.4 - 20	○	18	16	27.5	IT00	0.724 - 0.787	18.4 - 20	○	12	10
OT01	0.788 - 0.858	20.01 - 21.8	○	19.5	18	30	IT01	0.788 - 0.858	20.01 - 21.8	○	14	12
OT02	0.859 - 0.949	21.81 - 24.1	○	21.5	19.5	30	IT02	0.859 - 0.949	21.81 - 24.1	○	15	13
OT03	0.949 - 1.039	24.11 - 26.4	○	23.5	21	30	IT03	0.949 - 1.039	24.11 - 26.4	○	16	14
OT04	1.040 - 1.130	26.41 - 28.7	○	26	23.5	33	IT04	1.040 - 1.130	26.41 - 28.7	○	18	16
OT05	1.130 - 1.220	28.71 - 31	○	28	25.5	33	IT05	1.130 - 1.220	28.71 - 31	○	20	18
OT06	1.221 - 1.311	31.01 - 33.3	○	30.5	28	33	IT06	1.221 - 1.311	31.01 - 33.3	○	22	20
OT07	1.311 - 1.425	33.31 - 36.2	○	33	30	40	IT07	1.311 - 1.425	33.31 - 36.2	○	24	22
OT08	1.426 - 1.559	36.21 - 39.6	○	35.5	33	40	IT08	1.426 - 1.559	36.21 - 39.6	○	26	24
OT09	1.559 - 1.693	39.61 - 43	○	39	36	40	IT09	1.559 - 1.693	39.61 - 43	○	29	27
OT10	1.693 - 1.850	43.01 - 47	○	42.5	39	40	IT10	1.693 - 1.850	43.01 - 47	○	32	30
OT11	1.851 - 2.035	47.01 - 51.7	○	46.5	43	44	IT11	1.851 - 2.035	47.01 - 51.7	○	35	32
OT12	2.036 - 2.213	51.71 - 56.2	○	51	47	44	IT12	2.036 - 2.213	51.71 - 56.2	○	39	36
OT13	2.213 - 2.559	56.21 - 65	○	55.5	51	44	IT13	2.213 - 2.559	56.21 - 65	○	43	40
OT14	2.559 - 2.637	65 - 66.99	○	56	52	75	IT14	2.559 - 2.637	65 - 66.99	○	-	40
OT15	2.756 - 2.874	70 - 72.99	○	62	58	75	IT15	2.756 - 2.874	70 - 72.99	○	-	44
OT16	2.874 - 3.149	73 - 79.99	○	68	63	75	IT16	2.874 - 3.149	73 - 79.99	○	-	48
OT17	3.150 - 3.425	80 - 86.99	○	75	70	97	IT17	3.15 - 3.425	80 - 86.99	○	-	54
OT18	3.425 - 3.937	87 - 99.99	○	82	77	97	IT18	3.425 - 3.937	87 - 99.99	○	-	60
OT19	3.937 - 4.409	100 - 111.99	○	94	89	97	IT19	3.937 - 4.409	100 - 111.99	○	-	70
OT20	4.409 - 4.881	112 - 123.99	○	106	101	118	IT20	4.409 - 4.881	112 - 123.99	○	-	80
OT21	4.882 - 5.354	124 - 135.99	○	118	113	118	IT21	4.882 - 5.354	124 - 135.99	○	-	80
OT22	5.354 - 5.826	136 - 147.99	○	130	125	118	IT22	5.354 - 5.826	136 - 147.99	○	-	95
OT23	5.827 - 6.299	148 - 159.99	○	142	137	139	IT23	5.827 - 6.299	148 - 159.99	○	-	100
OT24	6.299 - 6.771	160 - 171.99	○	154	149	139	IT24	6.299 - 6.771	160 - 171.99	○	-	120
OT25	6.772 - 7.244	172 - 183.99	○	166	161	139	IT25	6.772 - 7.244	172 - 183.99	○	-	130

Please specify the length (OAL) when ordering.

e.g. For ø60 mm drill diameter / 1070 mm drill outer tube length: OT13X1070

Please choose the inner tube length according to the guide below:

- ▶ tool diameter: ø18.40 - ø65.00 mm (OT00 - OT13) ..... Inner tube length = Outer tube length + 30 mm
- ▶ tool diameter: ø65.00 - ø123.99 mm (OT14 - OT20) ..... Inner tube length = Outer tube length + 190 mm
- ▶ tool diameter: ø124.00 - ø183.99 mm (OT21 - OT25) ..... Inner tube length = Outer tube length + 220 mm

○ : Item to be customized

Reference pages: Drill head → **J136** (TRI-FINE DTS), **J141** (FINE-BEAM DTS), **J159** - (UNIDEX DTS), **J173** (ETU)



## Tube length for special drills

Please use the guide below to calculate the drill tube length.

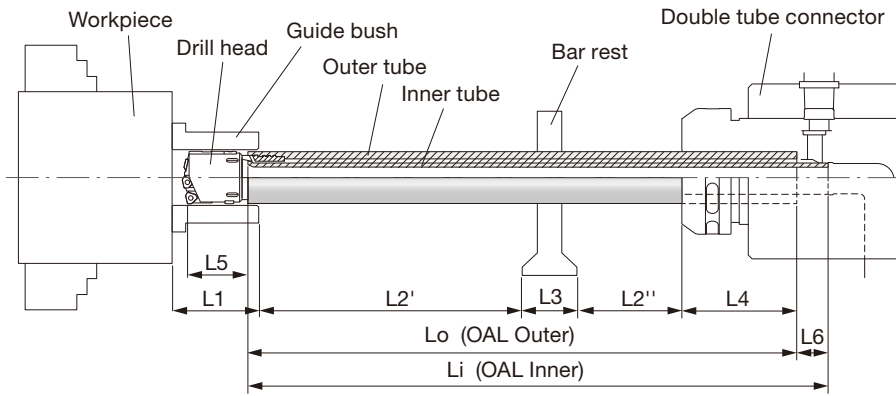

Lo = Outer tube overall length  
 Li = Inner tube overall length  
 L1 = Guide bush length (or pilot hole depth)  
 L2 = Drilling depth (L2' + L2'')  
 L3 = Bar rest length  
 L4 = Length of outer tube in connector\*  
 L5 = Length from drill tube tip and peripheral edge tip  
 L6 = Difference between outer tube length and inner tube length\*\*

$$\text{Outer tube overall length } L_o \approx L_1 + L_2 + L_3 + L_4 - L_5$$

$$\text{Inner tube overall length } L_i = L_o + L_6$$

DTC	L4*	L6**
DTC 4R (OT00 - OT13)	120	30
DTC 5R (OT14 - OT20)	0	190
DTC 6R (OT212 - OT25)	0	220

(mm)

For smooth drill entry, make sure that the drill head is inside the guide bushing (or pilot hole) all the way up to 5 mm over the outer tube.

### TRI-FINE



DCN - DCX		L5
(in)	(mm)	
0.724 - 0.787	18.4 - 20	31.5
0.788 - 0.858	20.01 - 21.8	33.5
0.859 - 0.866	21.81 - 21.99	33.5
0.866 - 0.949	22 - 24.1	35.5
0.949 - 0.984	24.11 - 25	35.5
0.985 - 1.039	25.01 - 26.4	37.5
1.040 - 1.102	26.41 - 28	37.5

### FINE-BEAM



DCN - DCX		L5
(in)	(mm)	
0.984 - 1.039	25 - 26.4	40
1.040 - 1.220	26.41 - 31	42
1.221 - 1.311	31.01 - 33.3	47
1.311 - 1.425	33.31 - 36.2	50
1.426 - 1.559	36.21 - 39.6	55
1.559 - 1.850	39.61 - 47	60
1.851 - 2.035	47.01 - 51.7	66
2.036 - 2.559	51.71 - 65	71

### UNIDEX



DCN - DCX		L5
(in)	(mm)	
1.496 - 1.693	38 - 43	45
1.693 - 1.850	43.01 - 47	55
1.851 - 2.035	47.01 - 51.7	51
2.036 - 2.213	51.71 - 56.2	56
2.213 - 2.559	56.21 - 65	66
2.559 - 3.149	65 - 79.99	75
3.150 - 4.409	80 - 111.99	83
4.409 - 5.826	112 - 147.99	87
5.827 - 7.244	148 - 183.99	86

### ETU



DCN - DCX		L5
(in)	(mm)	
0.724 - 0.787	18.4 - 20	20
0.788 - 0.949	20.01 - 24.1	23
0.949 - 1.130	24.11 - 28.7	24
1.130 - 1.311	28.71 - 33.3	27
1.311 - 1.425	33.31 - 36.2	26
1.426 - 1.598	36.21 - 40.6	29
1.599 - 1.693	40.61 - 43	28
1.693 - 1.850	43.01 - 47	30
1.851 - 2.035	47.01 - 51.7	29
2.036 - 2.213	51.71 - 56.2	32
2.213 - 2.299	56.21 - 58.4	34
2.300 - 2.559	58.41 - 65	33

Grade  
Insert  
Ext. Toolholder  
Int. Toolholder  
Threading  
Grooving  
Miniature tool  
Milling cutter  
Endmill  
Drilling tool  
Tooling System  
User's Guide  
Index





## Conversion adapter

### Adapter for external thread - internal thread conversion

An adapter to connect with a smaller tube diameter is also available upon request.

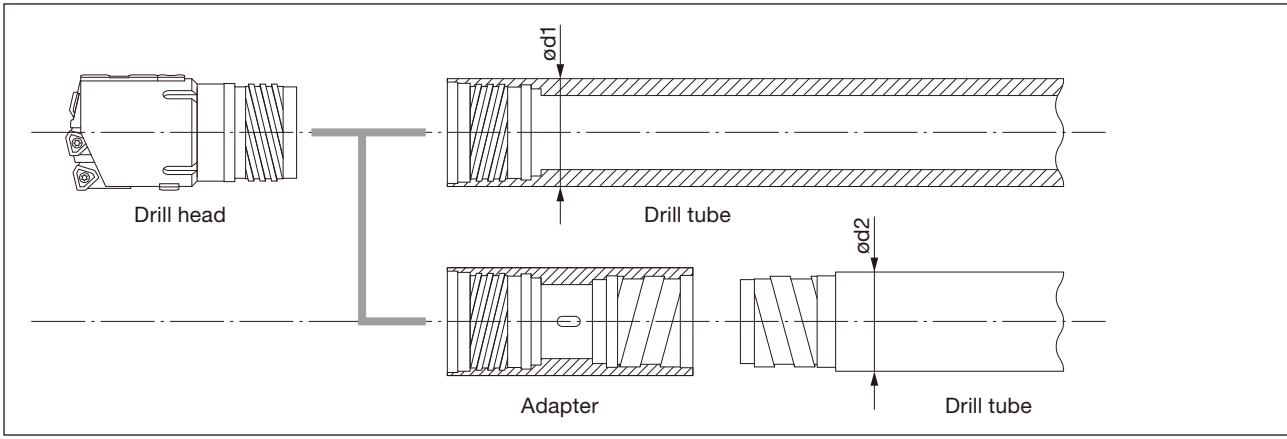

$\phi d1$  : Outer diameter of the tube that is applicable for the drill head  
 $\phi d2$  : Outer diameter of the tube that is connected with the adapter

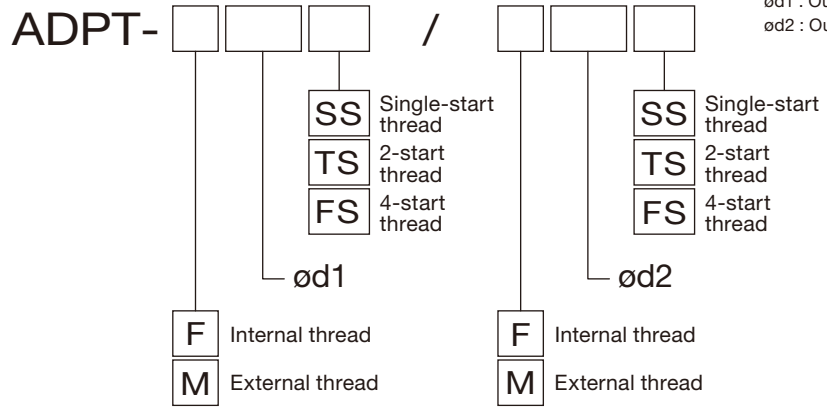

**Designation example**  
 For the conversion from ST11 to UB47  
**ADPT-F47FS / F47SS**

↑                      ↑  
 ST11                      UB47

# HF Drill : Indexable drill for deep hole



## Economical for middle range deep hole drilling

- Tool diameter range:  $\phi 30$  -  $\phi 63$  mm (\*)
- Drilling depth: 6xD - 14xD
- Shortened drilling time when using conventional machine

## Effective machining on conventional machines

- Recommended for use on Horizontal M/C
- Can also be used on turning machine

## Good chip evacuation

- FBM inserts enable best chip control
- Unique head design eliminates chip jamming
- Curved flute design ensures good chip evacuation

## Easy to use, rigid drill body

- Direct mount inserts, no diameter adjustment necessary
- Body is made from heat treated tool steel

## High quality surface finish

- Burnishing effect improves surface finish
- Possible to eliminate finish process

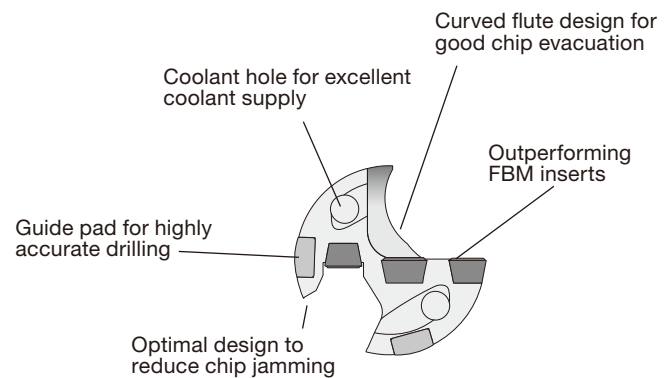

## PRACTICAL EXAMPLE

### Cutting conditions

Tool diameter DC:  $\phi 30$  mm  
 Drilling depth: 200 mm  
 Workpiece material: S45C  
 Cutting speed  $V_c$ : 100 m/min  
 Feed  $f$ : 0.1 mm/rev  
 Machine: BT50 M/C

No spiral marks caused by chips  
 Burnishing effect by guide pads improves surface finish

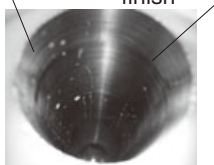

### BT50 M/C Machining data

**Excellent chip evacuation ensures the stable drilling on M/C.**

Cutting speed  $V_c$  (m/min)

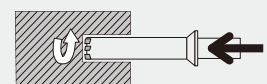
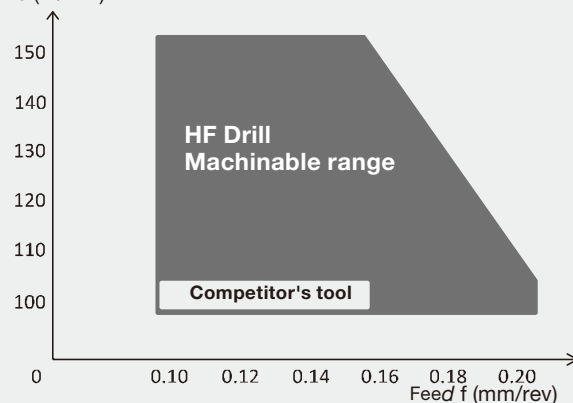

- Water-soluble coolant
- Pressure: 1.5 MPa
- Through spindle

Tool diameter DC:  $\phi 30$  mm  
 Drilling depth: 200 mm  
 Workpiece material: S45C  
 Cutting speed  $V_c$ : 100 - 150 m/min  
 Feed  $f$ : 0.1 - 0.2 mm/rev  
 Machine: BT50 Horizontal M/C (Max 11 kW)

## Cautionary points in use

To start the tool, a pilot hole is required. (tolerance: + 0.1 to 0.15 mm)

Tool diameter DC (mm)	Pilot hole length H (mm)
$\phi 30 \sim \phi 39$	$10 \leq$
$\phi 39.01 \sim \phi 45$	$12.5 \leq$
$\phi 45.01 \sim \phi 57$	$15 \leq$
$\phi 57.01 \sim \phi 63$	$17.5 \leq$

- The pilot hole should ideally have a flat bottom, but generally an indexable drill is acceptable to create a pilot hole if the inner insert touches the bottom last.
- DrillForce-Meister series or TDX drills are recommended for a pilot hole drilling.



# REAMMEISTER

## TRM

Exchangeable head reamer, L/D = 1.5, 3, 5, 8

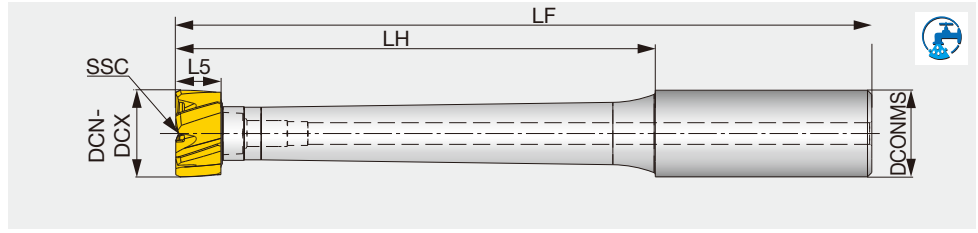

Inch	DCN (in)	DCN (mm)	DCX (in)	DCX (mm)	SSC	L/D	DCONMS	L5	LF	LH
TRMU-T5-R0.625-1.5	0.45276	11.5	0.5315	13.5	T5	1.5	15.875	9.3	77.7	29.7
TRMU-T6-R0.625-1.5	0.53154	13.501	0.62993	16	T6	1.5	15.875	9.4	81.5	33.5
TRMU-T7-R0.75-1.5	0.62996	16.001	0.7874	20	T7	1.5	19.05	10.6	90.7	40.6
TRMU-T8-R0.75-1.5	0.78744	20.001	1.02358	25.999	T8	1.5	19.05	12.8	101.1	51.1
TRMU-T9-R1.25-1.5	1.02362	26	1.25984	32	T9	1.5	31.75	12.8	120.9	61.0
TRMU-T5-R0.625-3	0.45276	11.5	0.5315	13.5	T5	3	15.875	9.3	97.8	49.8
TRMU-T6-R0.625-3	0.53154	13.501	0.62993	16	T6	3	15.875	9.4	105.4	57.4
TRMU-T7-R0.75-3	0.62996	16.001	0.7874	20	T7	3	19.05	10.6	120.4	70.6
TRMU-T8-R0.75-3	0.78744	20.001	1.02358	25.999	T8	3	19.05	12.8	137.7	87.6
TRMU-T9-R1.25-3	1.02362	26	1.25984	32	T9	3	31.75	12.8	167.1	106.9
TRMU-T5-R0.625-5	0.45276	11.5	0.5315	13.5	T5	5	15.875	9.3	125.0	77.0
TRMU-T6-R0.625-5	0.53154	13.501	0.62993	16	T6	5	15.875	9.4	137.4	89.4
TRMU-T7-R0.75-5	0.62996	16.001	0.7874	20	T7	5	19.05	10.6	160.5	110.5
TRMU-T8-R0.75-5	0.78744	20.001	1.02358	25.999	T8	5	19.05	12.8	187.7	137.7
TRMU-T9-R1.25-5	1.02362	26	1.25984	32	T9	5	31.75	12.8	231.1	171.2
TRMU-T5-R0.625-8	0.45276	11.5	0.5315	13.5	T5	8	15.875	9.3	165.4	117.3
TRMU-T6-R0.625-8	0.53154	13.501	0.62993	16	T6	8	15.875	9.4	185.4	137.4
TRMU-T7-R0.75-8	0.62996	16.001	0.7874	20	T7	8	19.05	10.6	220.5	170.7
TRMU-T8-R0.75-8	0.78744	20.001	1.02358	25.999	T8	8	19.05	12.8	262.9	212.9
TRMU-T9-R1.25-8	1.02362	26	1.25984	32	T9	8	31.75	12.8	327.2	267.0

Metric	DCN (in)	DCN (mm)	DCX (in)	DCX (mm)	SSC	L/D	DCONMS	L5	LF	LH
TRM-T5-R16-1.5	0.45276	11.5	0.5315	13.5	T5	1.5	0.625	0.366	3.06	1.17
TRM-T6-R16-1.5	0.53154	13.501	0.62993	16	T6	1.5	0.625	0.37	3.21	1.32
TRM-T7-R20-1.5	0.62996	16.001	0.7874	20	T7	1.5	0.75	0.417	3.57	1.6
TRM-T8-R20-1.5	0.78744	20.001	1.02358	25.999	T8	1.5	0.75	0.504	3.98	2.01
TRM-T9-R32-1.5	1.02362	26	1.25984	32	T9	1.5	1.25	0.504	4.76	2.4
TRM-T5-R16-3	0.45276	11.5	0.5315	13.5	T5	3	0.625	0.366	3.85	1.96
TRM-T6-R16-3	0.53154	13.501	0.62993	16	T6	3	0.625	0.37	4.15	2.26
TRM-T7-R20-3	0.62996	16.001	0.7874	20	T7	3	0.75	0.417	4.74	2.78
TRM-T8-R20-3	0.78744	20.001	1.02358	25.999	T8	3	0.75	0.504	5.42	3.45
TRM-T9-R32-3	1.02362	26	1.25984	32	T9	3	1.25	0.504	6.58	4.21
TRM-T5-R16-5	0.45276	11.5	0.5315	13.5	T5	5	0.625	0.366	4.92	3.03
TRM-T6-R16-5	0.53154	13.501	0.62993	16	T6	5	0.625	0.37	5.41	3.52
TRM-T7-R20-5	0.62996	16.001	0.7874	20	T7	5	0.75	0.417	6.32	4.35
TRM-T8-R20-5	0.78744	20.001	1.02358	25.999	T8	5	0.75	0.504	7.39	5.42
TRM-T9-R32-5	1.02362	26	1.25984	32	T9	5	1.25	0.504	9.1	6.74
TRM-T5-R16-8	0.45276	11.5	0.5315	13.5	T5	8	0.625	0.366	6.51	4.62
TRM-T6-R16-8	0.53154	13.501	0.62993	16	T6	8	0.625	0.37	7.3	5.41
TRM-T7-R20-8	0.62996	16.001	0.7874	20	T7	8	0.75	0.417	8.68	6.72
TRM-T8-R20-8	0.78744	20.001	1.02358	25.999	T8	8	0.75	0.504	10.35	8.38
TRM-T9-R32-8	1.02362	26	1.25984	32	T9	8	1.25	0.504	12.88	10.51

Key and screw are included.

Maximum effective reaming depth = Head diameter x L/D ratio.

Ex. For a reamer with ø0.5": 0.5" x 3D = 1.5"

**SPARE PARTS**



Designation	Screw	Key
TRM-T5-R16-1.5	SCR-TRM-T5	K-TRM-T5
TRM-T6-R16-1.5	SCR-TRM-T6	K-TRM-T6
TRM-T7-R20-1.5	SCR-TRM-T7	K-TRM-T7
TRM-T8-R20-1.5	SCR-TRM-T8	K-TRM-T8
TRM-T9-R32-1.5	SCR-TRM-T9	K-TRM-T9
TRM-T5-R16-3	SCR-TRM-T5	K-TRM-T5
TRM-T6-R16-3	SCR-TRM-T6	K-TRM-T6
TRM-T7-R20-3	SCR-TRM-T7	K-TRM-T7
TRM-T8-R20-3	SCR-TRM-T8	K-TRM-T8
TRM-T9-R32-3	SCR-TRM-T9	K-TRM-T9
TRM-T5-R16-5	SCR-TRM-T5	K-TRM-T5
TRM-T6-R16-5	SCR-TRM-T6	K-TRM-T6
TRM-T7-R20-5	SCR-TRM-T7	K-TRM-T7
TRM-T8-R20-5	SCR-TRM-T8	K-TRM-T8
TRM-T9-R32-5	SCR-TRM-T9	K-TRM-T9
TRM-T5-R16-8	SCR-TRM-T5	K-TRM-T5
TRM-T6-R16-8	SCR-TRM-T6	K-TRM-T6
TRM-T7-R20-8	SCR-TRM-T7	K-TRM-T7
TRM-T8-R20-8	SCR-TRM-T8	K-TRM-T8
TRM-T9-R32-8	SCR-TRM-T9	K-TRM-T9
TRMU-T5-R0.625-1.5	SCR-TRM-T5	K-TRM-T5
TRMU-T6-R0.625-1.5	SCR-TRM-T6	K-TRM-T6
TRMU-T7-R0.75-1.5	SCR-TRM-T7	K-TRM-T7
TRMU-T8-R0.75-1.5	SCR-TRM-T8	K-TRM-T8
TRMU-T9-R1.25-1.5	SCR-TRM-T9	K-TRM-T9
TRMU-T5-R0.625-3	SCR-TRM-T5	K-TRM-T5
TRMU-T6-R0.625-3	SCR-TRM-T6	K-TRM-T6
TRMU-T7-R0.75-3	SCR-TRM-T7	K-TRM-T7
TRMU-T8-R0.75-3	SCR-TRM-T8	K-TRM-T8
TRMU-T9-R1.25-3	SCR-TRM-T9	K-TRM-T9
TRMU-T5-R0.625-5	SCR-TRM-T5	K-TRM-T5
TRMU-T6-R0.625-5	SCR-TRM-T6	K-TRM-T6
TRMU-T7-R0.75-5	SCR-TRM-T7	K-TRM-T7
TRMU-T8-R0.75-5	SCR-TRM-T8	K-TRM-T8
TRMU-T9-R1.25-5	SCR-TRM-T9	K-TRM-T9
TRMU-T5-R0.625-8	SCR-TRM-T5	K-TRM-T5
TRMU-T6-R0.625-8	SCR-TRM-T6	K-TRM-T6
TRMU-T7-R0.75-8	SCR-TRM-T7	K-TRM-T7
TRMU-T8-R0.75-8	SCR-TRM-T8	K-TRM-T8
TRMU-T9-R1.25-8	SCR-TRM-T9	K-TRM-T9

Grade

A

Insert

B

Ext. Toolholder

C

Int. Toolholder

D

Threading

E

Grooving

F

Miniature tool

G

Milling cutter

H

Endmill

I

Drilling tool

J

Tooling System

K

User's Guide

L

Index

M

Reference pages: Head → **J184**, Standard cutting conditions → **J187**

# REAMER HEAD

## HRM-AS (for blind holes)

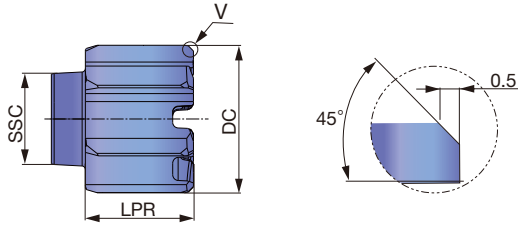

## HRM-BL (for through holes)

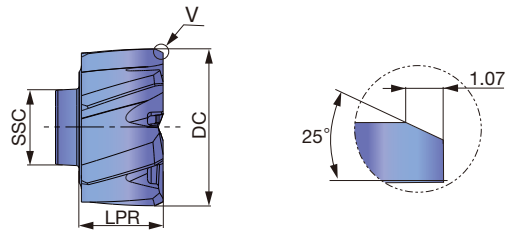

Designation	DC (in)	DC (mm)	AH725	SSC	LPR	CICT	Edge type	Flute type
HRM-11.501-AS-T5	0.4528	11.501	●	T5	9.3	6	A	S
HRM-12.000-AS-T5	0.47244	12	●	T5	9.3	6	A	S
HRM-12.700-AS-T5	0.51181	12.7	●	T5	9.3	6	A	S
HRM-13.000-AS-T5	0.53149	13	●	T5	9.3	6	A	S
HRM-13.500-AS-T5	0.55118	13.5	●	T5	9.3	6	A	S
HRM-14.000-AS-T6	0.59055	14	●	T6	9.4	6	A	S
HRM-15.000-AS-T6	0.62992	15	●	T6	9.4	6	A	S
HRM-15.875-AS-T6	0.62996	15.875	●	T6	9.4	6	A	S
HRM-16.000-AS-T6	0.66929	16	●	T6	9.4	6	A	S
HRM-16.001-AS-T7	0.70866	16.001	●	T7	10.6	6	A	S
HRM-17.000-AS-T7	0.74803	17	●	T7	10.6	6	A	S
HRM-18.000-AS-T7	0.7874	18	●	T7	10.6	6	A	S
HRM-19.000-AS-T7	0.78744	19	●	T7	10.6	6	A	S
HRM-19.050-AS-T7	0.82677	19.05	●	T7	10.6	6	A	S
HRM-20.000-AS-T7	0.86614	20	●	T7	10.6	6	A	S
HRM-20.001-AS-T8	0.90551	20.001	●	T8	12.8	8	A	S
HRM-21.000-AS-T8	0.94488	21	●	T8	12.8	8	A	S
HRM-22.000-AS-T8	0.98425	22	●	T8	12.8	8	A	S
HRM-23.000-AS-T8	1.02362	23	●	T8	12.8	8	A	S
HRM-24.000-AS-T8	1.06299	24	●	T8	12.8	8	A	S
HRM-25.000-AS-T8	1.10236	25	●	T8	12.8	8	A	S
HRM-25.400-AS-T8	1.14173	25.4	●	T8	12.8	8	A	S
HRM-26.000-AS-T9	1.1811	26	●	T9	12.8	8	A	S
HRM-27.000-AS-T9	1.22047	27	●	T9	12.8	8	A	S
HRM-28.000-AS-T9	1.25984	28	●	T9	12.8	8	A	S
HRM-29.000-AS-T9	0.5	29	●	T9	12.8	8	A	S
HRM-30.000-AS-T9	0.625	30	●	T9	12.8	8	A	S
HRM-31.000-AS-T9	0.75	31	●	T9	12.8	8	A	S
HRM-31.750-AS-T9	1	31.75	●	T9	12.8	8	A	S
HRM-32.000-AS-T9	1.25	32	●	T9	12.8	8	A	S

Package quantity = 1 pcs.  
●: Line up

Designation	DC (in)	DC (mm)	AH725	SSC	LPR	CICT	Edge type	Flute type
HRM-11.501-BL-T5	0.4528	11.501	●	T5	9.3	6	B	L
HRM-12.000-BL-T5	0.47244	12	●	T5	9.3	6	B	L
HRM-12.700-BL-T5	0.51181	12.7	●	T5	9.3	6	B	L
HRM-13.000-BL-T5	0.5315	13	●	T5	9.3	6	B	L
HRM-13.500-BL-T5	0.53154	13.5	●	T5	9.3	6	B	L
HRM-13.501-BL-T6	0.55118	13.501	●	T6	9.4	6	B	L
HRM-14.000-BL-T6	0.59055	14	●	T6	9.4	6	B	L
HRM-15.000-BL-T6	0.62992	15	●	T6	9.4	6	B	L
HRM-15.875-BL-T6	0.62996	15.875	●	T6	9.4	6	B	L
HRM-16.000-BL-T6	0.66929	16	●	T6	9.4	6	B	L
HRM-16.001-BL-T7	0.70866	16.001	●	T7	10.6	6	B	L
HRM-17.000-BL-T7	0.74803	17	●	T7	10.6	6	B	L
HRM-18.000-BL-T7	0.7874	18	●	T7	10.6	6	B	L
HRM-19.000-BL-T7	0.78744	19	●	T7	10.6	6	B	L
HRM-19.050-BL-T7	0.82677	19.05	●	T7	10.6	6	B	L
HRM-20.000-BL-T7	0.86614	20	●	T7	10.6	6	B	L
HRM-20.001-BL-T8	0.90551	20.001	●	T8	12.8	8	B	L
HRM-21.000-BL-T8	0.94488	21	●	T8	12.8	8	B	L
HRM-22.000-BL-T8	0.98425	22	●	T8	12.8	8	B	L
HRM-23.000-BL-T8	1.02362	23	●	T8	12.8	8	B	L
HRM-24.000-BL-T8	1.06299	24	●	T8	12.8	8	B	L
HRM-25.000-BL-T8	1.10236	25	●	T8	12.8	8	B	L
HRM-25.400-BL-T8	1.14173	25.4	●	T8	12.8	8	B	L
HRM-26.000-BL-T9	1.1811	26	●	T9	12.8	8	B	L
HRM-27.000-BL-T9	1.22047	27	●	T9	12.8	8	B	L
HRM-28.000-BL-T9	1.25984	28	●	T9	12.8	8	B	L
HRM-29.000-BL-T9	0.5	29	●	T9	12.8	8	B	L
HRM-30.000-BL-T9	0.625	30	●	T9	12.8	8	B	L
HRM-31.000-BL-T9	0.75	31	●	T9	12.8	8	B	L
HRM-32.000-BL-T9	1	32	●	T9	12.8	8	B	L

Package quantity = 1 pcs.  
●: Line up

### Inch

Head diameter range	Tolerance range of the head	Hole diameter tolerance (H7)
ø0.45276 - ø0.70866	+0.00059 / +0.00043	+0.00071 / 0
ø0.70870 - ø1.18110	+0.00067 / +0.00051	+0.00083 / 0
ø1.18114 - ø1.25984	+0.00083 / +0.00063	+0.00098 / 0

### Metric

Head diameter range	Tool diameter tolerance	Hole diameter tolerance*
ø11.500 - ø18.000	+0.015 / +0.011	+0.018 / 0
ø18.001 - ø30.000	+0.017 / +0.013	+0.021 / 0
ø30.001 - ø32.000	+0.021 / +0.016	+0.025 / 0

\*Just for reference

All standard heads are designed to achieve H7 hole tolerance. Head diameters are produced so that the hole diameter achieved is close to the max tolerance limit.

### Inch

Head diameter range	Tolerance range of the head	Hole diameter tolerance (H7)
ø0.45276 - ø0.70866	+0.00059 / +0.00043	+0.00071 / 0
ø0.70870 - ø1.18110	+0.00067 / +0.00051	+0.00083 / 0
ø1.18114 - ø1.25984	+0.00083 / +0.00063	+0.00098 / 0

### Metric

Head diameter range	Tool diameter tolerance	Hole diameter tolerance*
ø11.500 - ø18.000	+0.015 / +0.011	+0.018 / 0
ø18.001 - ø30.000	+0.017 / +0.013	+0.021 / 0
ø30.001 - ø32.000	+0.021 / +0.016	+0.025 / 0

\*Just for reference

All standard heads are designed to achieve H7 hole tolerance. Head diameters are produced so that the hole diameter achieved is close to the max tolerance limit.



## Reaming allowance

- Reaming allowance  $\Delta$  is the stock material to be removed in the reaming process. For a successful reaming operation, reaming allowance must be determined with proper considerations. Refer to the table below for appropriate reaming allowance for various hole diameters and materials. Standard reaming allowance, unless otherwise required, will be the target diameter +0.0079" for all hole diameter ranges and materials.
- Reaming quality largely depends on the quality of the pre-hole. Pre-holes must have no diameter fluctuation and good straightness.

$\Delta$  : Reaming allowance

$$\Delta = \phi DR - \phi DP$$

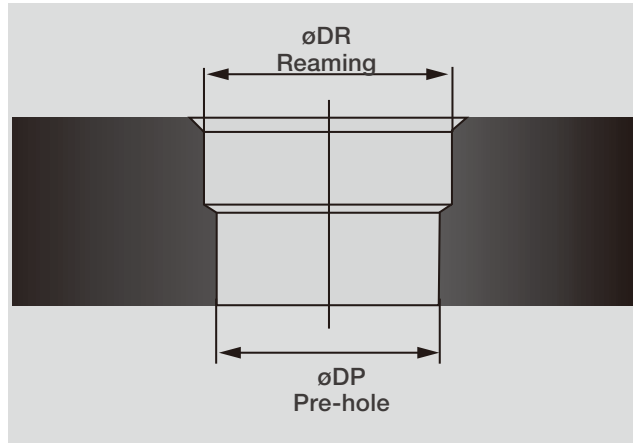

Workpiece material	Hole diameter (inch)			
	0.45276 - 0.53150	0.53154 - 0.62992	0.62996 - 1.02362	1.02366 - 1.25984
Steel and cast Iron	$\Delta = 0.00394 - 0.00787$	$\Delta = 0.00394 - 0.01181$	$\Delta = 0.00394 - 0.01575$	$\Delta = 0.00787 - 0.01969$
Aluminum and brass	$\Delta = 0.00591 - 0.00984$	$\Delta = 0.00787 - 0.01181$	$\Delta = 0.00787 - 0.01969$	$\Delta = 0.00787 - 0.02362$

**Make a guide hole with a shorter reamer (1.5D or 3D), then use a long overhang tool.  
(Best option for using an 8D tool)**

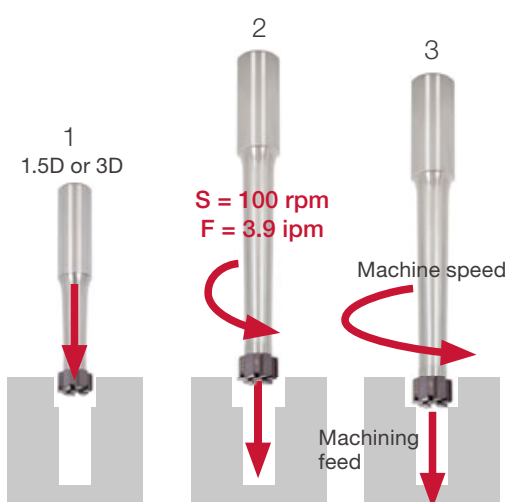

1. Use a shorter reamer (1.5D or 3D) to make a guide hole with a depth of 0.5xD~1xD.
2. Insert the long reamer (8D) in the guide hole rotating at a low speed (<100 rpm) and feeding slowly (at F = 3.9 ipm) until the reamer reaches several millimeters from the bottom.
3. Rotate the reamer with the full machining speed and start feeding.

\*Use the same diameter heads for both piloting and deep reaming processes

## TAILORED REAMER HEAD

Tungaloy will produce reaming heads with customized diameters and tooth geometries tailored to your specific application needs. Provide the necessary information below or contact your local distributor or Tungaloy sales team.

### Information sheet for quotation & order

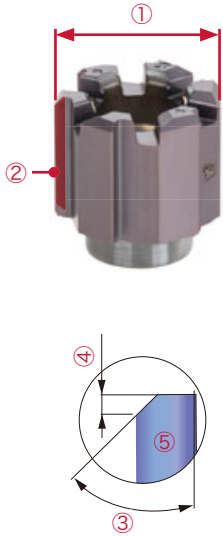

Hole diameter and tolerance	∅		
Surface finish	<input type="checkbox"/> Ra	<input type="checkbox"/> Rz	
Workpiece material			
① Head diameter	∅		(0.001 unit)
② Flute type	<input type="checkbox"/> Straight	<input type="checkbox"/> Helix, Left	<input type="checkbox"/> Helix, Right
③ Engagement angle	(20° - 90°)		
④ Cutting edge length			
⑤ Corner shape	<input type="checkbox"/> Up sharp	<input type="checkbox"/> Round	(R0.2 or higher)
Other specific needs			

# STANDARD CUTTING CONDITIONS

## Conversion table for feed per tooth

ISO	Workpiece materials	Hardness	Cutting speed Vc (sfm)	Feed: fz (ipt)			
				AS: Straight flute (for blind holes)		BL: Left hand flute (for through holes)	
				$\phi 0.45280$	$\phi 0.62992$	$\phi 0.62996$	$\phi 1.25984$
<b>P</b>	Low carbon steel (C<0.3) 1018, 1020, 1026, E275A, etc.	- 200 HB	262 - 656	0.00197 - 0.00709	0.00197 - 0.00787	0.00197 - 0.00787	0.00197 - 0.01063
	Carbon steel (C>0.3) 1045, 1055, etc.	- 300 HB	262 - 492	0.00197 - 0.00591	0.00197 - 0.00709	0.00197 - 0.00709	0.00197 - 0.00984
	Low alloy steel (C<0.3) 5120, etc.	- 200 HB	262 - 656	0.00197 - 0.00709	0.00197 - 0.00787	0.00197 - 0.00787	0.00197 - 0.01063
	Alloy steel (C>0.3) 4140, 8620, etc.	- 300 HB	164 - 492	0.00118 - 0.00394	0.00197 - 0.00512	0.00197 - 0.00512	0.00197 - 0.00669
<b>M</b>	Stainless steel (Austenitic) 304, 316, etc.	- 200 HB	66 - 131	0.00118 - 0.00394	0.00118 - 0.00512	0.00197 - 0.00512	0.00197 - 0.00669
	Stainless steel (Martensitic and ferritic) 410, 416, etc.	- 200 HB	66 - 131	0.00118 - 0.00394	0.00118 - 0.00512	0.00197 - 0.00512	0.00197 - 0.00669
	Stainless steel (Precipitation hardening) S17400, etc.	-	66 - 131	0.00118 - 0.00394	0.00118 - 0.00512	0.00197 - 0.00512	0.00197 - 0.00669
<b>K</b>	Gray cast iron Class No.25, No.30, No.35, etc.	150 - 250 HB	328 - 820	0.00197 - 0.00709	0.00197 - 0.00787	0.00197 - 0.00787	0.00197 - 0.01063
	Ductile cast iron 100-70-03, etc.	150 - 250 HB	262 - 656	0.00197 - 0.00591	0.00197 - 0.00709	0.00197 - 0.00709	0.00197 - 0.00984
<b>N</b>	Aluminum alloy	-	328 - 984	0.00197 - 0.00709	0.00197 - 0.00787	0.00197 - 0.00787	0.00197 - 0.01063
<b>S</b>	High temp. alloy Inconel718 etc.	- 40 HRC	49 - 164	0.00118 - 0.00236	0.00118 - 0.00315	0.00197 - 0.00394	0.00197 - 0.00512
	Titanium alloy Ti-6Al-4V etc.	- 40 HRC	98 - 197	0.00118 - 0.00394	0.00118 - 0.00512	0.00197 - 0.00512	0.00197 - 0.00669
<b>H</b>	Hardened steel Over 40HRC etc.	- 50 HRC	164 - 328	0.00118 - 0.00315	0.00118 - 0.00394	0.00197 - 0.00472	0.00197 - 0.00591

## Conversion table for feed per revolution

ISO	Workpiece materials	Hardness	Cutting speed Vc (sfm)	Feed: f (ipr)							
				AS: Straight flute (for blind holes)			BL: Left hand flute (for through holes)				
				$\phi 0.45280$	$\phi 0.62992$	$\phi 0.62996$	$\phi 0.78744$	$\phi 0.78744$	$\phi 1.25984$	$\phi 0.45280$	$\phi 0.62992$
<b>P</b>	Low carbon steel (C<0.3) 1018, 1020, 1026, E275A, etc.	- 200 HB	262 - 656	0.01181 - 0.04252	0.01181 - 0.04724	0.01575 - 0.06299	0.01181 - 0.04724	0.01181 - 0.06378	0.01575 - 0.08504		
	Carbon steel (C>0.3) 1045, 1055, etc.	- 300 HB	262 - 492	0.01181 - 0.03543	0.01181 - 0.04252	0.01575 - 0.05669	0.01181 - 0.04252	0.01181 - 0.05906	0.01575 - 0.07874		
	Low alloy steel (C<0.3) 5120, etc.	- 200 HB	262 - 656	0.01181 - 0.04252	0.01181 - 0.04724	0.01575 - 0.06299	0.01181 - 0.04724	0.01181 - 0.04724	0.01575 - 0.08504		
	Alloy steel (C>0.3) 4140, 8620, etc.	- 300 HB	164 - 492	0.00709 - 0.02362	0.00709 - 0.03071	0.01575 - 0.04094	0.01181 - 0.03071	0.01181 - 0.04016	0.01575 - 0.05354		
<b>M</b>	Stainless steel (Austenitic) 304, 316, etc.	- 200 HB	66 - 131	0.00709 - 0.02362	0.00709 - 0.03071	0.00945 - 0.04094	0.01181 - 0.03071	0.01181 - 0.04016	0.01575 - 0.05354		
	Stainless steel (Martensitic and ferritic) 410, 416, etc.	- 200 HB	66 - 131	0.00709 - 0.02362	0.00709 - 0.03071	0.00945 - 0.04094	0.01181 - 0.03071	0.01181 - 0.04016	0.01575 - 0.05354		
	Stainless steel (Precipitation hardening) S17400, etc.	-	66 - 131	0.00709 - 0.02362	0.00709 - 0.03071	0.00945 - 0.04094	0.01181 - 0.03071	0.01181 - 0.04016	0.01575 - 0.05354		
<b>K</b>	Gray cast iron Class No.25, No.30, No.35, etc.	150 - 250 HB	328 - 820	0.01181 - 0.04252	0.01181 - 0.04724	0.01575 - 0.06299	0.01181 - 0.04724	0.01181 - 0.06378	0.01575 - 0.08504		
	Ductile cast iron 100-70-03, etc.	150 - 250 HB	262 - 656	0.01181 - 0.03543	0.01181 - 0.04252	0.01575 - 0.05669	0.01181 - 0.07087	0.01181 - 0.06378	0.01575 - 0.07874		
<b>N</b>	Aluminum alloy	-	328 - 984	0.01181 - 0.04252	0.01181 - 0.04724	0.01575 - 0.06299	0.01181 - 0.04724	0.01181 - 0.06378	0.01575 - 0.08504		
<b>S</b>	High temp. alloy Inconel718 etc.	- 40 HRC	49 - 164	0.00709 - 0.01417	0.00709 - 0.01890	0.00945 - 0.02520	0.01181 - 0.02362	0.01181 - 0.03071	0.01575 - 0.04094		
	Titanium alloy Ti-6Al-4V etc.	- 40 HRC	98 - 197	0.00709 - 0.02362	0.00709 - 0.03071	0.00945 - 0.04094	0.01181 - 0.03071	0.01181 - 0.04016	0.01575 - 0.05354		
<b>H</b>	Hardened steel Over 40HRC etc.	- 50 HRC	164 - 328	0.00709 - 0.01890	0.00709 - 0.02362	0.00945 - 0.03150	0.01181 - 0.02835	0.01181 - 0.03543	0.01575 - 0.04724		

Grade  
Insert  
Toolholder  
Ext. Toolholder  
Int. Toolholder  
Threading  
Grooving  
Miniature tool  
Milling cutter  
Endmill  
Drilling tool  
Tooling System  
User's Guide  
Index

