



For more information

Multifunctional tool for drilling and turning

TUNGB^{ORE}MINI

Tungaloy Report No. 529S3-G

Expansion of **DMIN 8mm** to the lineup



New toolholders for the minimum bore diameter (DMIN) range of $\varnothing 8$ mm

■ New Line ups

TUNGB ^{ORE} MINI	Minimum bore diameter: DMIN (mm)								
	$\varnothing 8$	$\varnothing 10$	$\varnothing 12$	$\varnothing 14$	$\varnothing 16$	$\varnothing 18$	$\varnothing 20$	$\varnothing 25$	$\varnothing 32$
	New								

■ Features

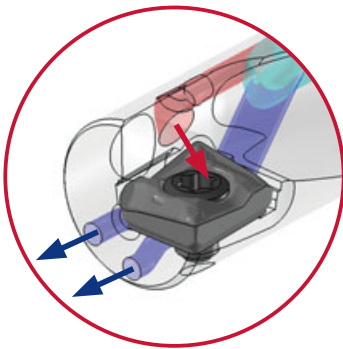

Optimized through-coolant ensures effective chip evacuation during machining

Single-sided insert with 2 corners

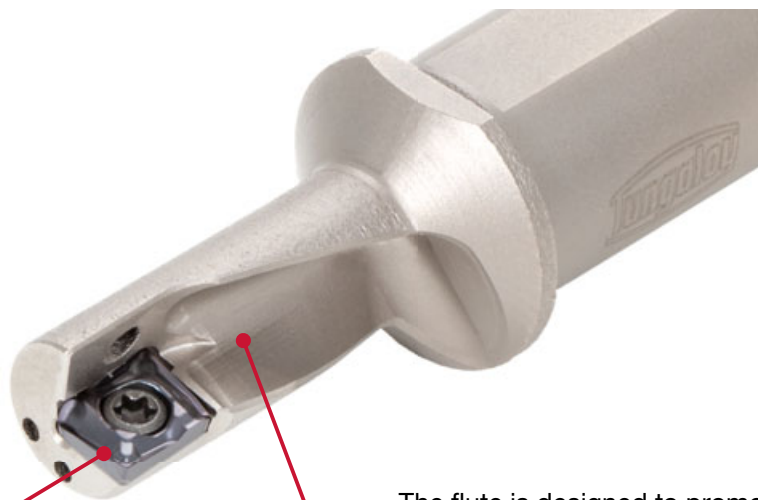

The flute is designed to promote smooth chip flow, while ensuring tool rigidity

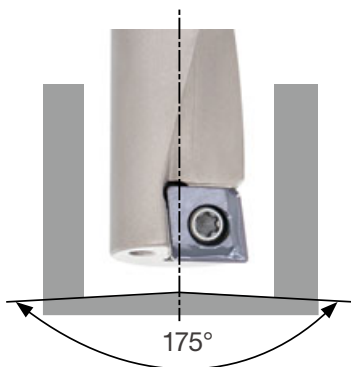

Creates a near-flat hole bottom

Optimized chipbreaker design enables effective chip control in all applications

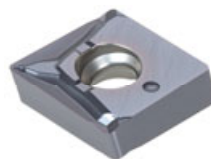

XOMU-PS

For toolholders for DMIN = 10 - 32 mm



New

XCMT-PS

For toolholders for DMIN = 8 mm

CUTTING PERFORMANCE

Drilling

P Holder : TBM08RF12-2.25
 Insert : XCMT040102R-PS AH725
 Workpiece material : S45C / C45
 Cutting speed : $V_c = 100$ m/min
 Application : Drilling
 Coolant : Internal

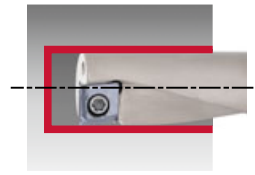

Drilling

0.02	0.03	0.04	0.05
Feed: f (mm/rev)			

Stable machining and excellent chip control during hole making process.

Internal turning

P Holder : TBM08RF12-2.25
 Insert : XCMT040102R-PS AH725
 Workpiece material : S45C / C45
 Cutting speed : $V_c = 150$ m/min
 Application : Internal turning
 Coolant : Internal

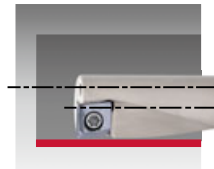

Turning

Depth of cut: ap (mm)	1				
	0.5				
	0.2				
		0.04	0.06	0.1	0.12
Feed: f (mm/rev)					

Excellent chip control during I.D. finishing operation.

TBM

Maximum hole depth for L/D = 2.25

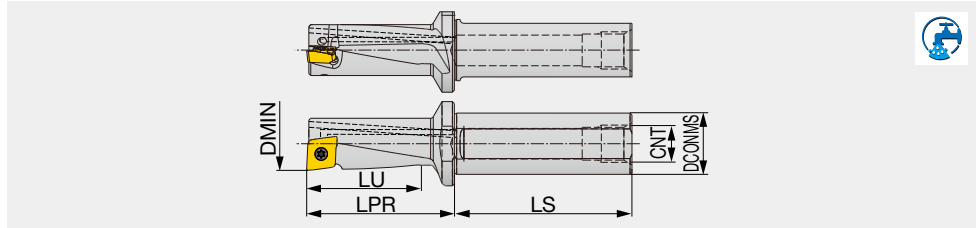

Designation	DMIN	DCONMS	LU	LS	LPR	CNT	Insert	Torque*
New TBM08RF12-2.25	8	12	18	41.5	22.5	-	XCMT040102R-PS	0.7
TBM10R/LF12-2.25	10	12	22.5	41.5	28.45	UNF 5/16-24	XOMU05X204-PS	0.7
TBM12R/LF16-2.25	12	16	27	43.9	33.53	G 1/8	XOMU06H204-PS	1
TBM14R/LF16-2.25	14	16	31.5	46.4	38.57	G 1/8	XOMU07H304-PS	1.3
TBM16R/LF20-2.25	16	20	36	57.1	42.9	G 1/8	XOMU08T304-PS	2.3
TBM18RF25-2.25	18	25	40.5	54	53.96	G 1/8	XOMU09T304-PS	2.3
TBM20RF25-2.25	20	25	45	54	54.94	G 1/8	XOMU100404-PS	3.5
TBM25RF32-2.25	25	32	56.5	59	69	G 1/8	XOMU120404-PS	3.5
TBM32RF40-2.25	32	40	72	69	87.95	G 1/8	XOMU160508-PS	3.5

Torque*: Recommended clamping torque (N·m)

SPARE PARTS



Designation	Clamping screw	Wrench
TBM08R...	CSTD-1.8	T-6D
TBM10R...	CSTB-2L040	T-6D
TBM12R...	CSPB-2.2	IP-7D
TBM14R...	CSPB-2.5	IP-8D
TBM16R..., TBM18RF...	CSTB-3	T-9D
TBM20RF...	CSPB-3.5	IP-15D
TBM25RF...	CSTB-4	T-15D
TBM32RF...	CSTB-4.5L110P	T-15D

INSERT

XOMU-PS

XCMT-PS

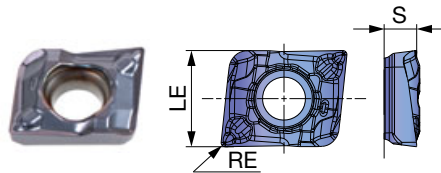
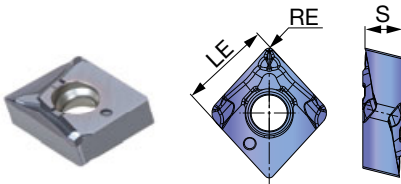

P Steel	★									
M Stainless	★									
K Cast iron	★									
N Non-ferrous	★									
S Superalloys										
H Hard materials										

★ : First choice

Designation	RE	Coated										S	LE	
		AH725												
XCMT040102R-PS	0.2	●											1.59	4.7
XOMU05X204-PS	0.4	●											2.3	5.56
XOMU06H204-PS	0.4	●											2.7	6.3
XOMU07H304-PS	0.4	●											3.3	7.3
XOMU08T304-PS	0.4	●											3.97	8.3
XOMU09T304-PS	0.4	●											3.97	9.3
XOMU100404-PS	0.4	●											4.76	10.3
XOMU120404-PS	0.4	●											4.76	12.8
XOMU160508-PS	0.8	●											5.56	16.3

● : New product

● : Line up

STANDARD CUTTING CONDITIONS

Drilling

ISO	Workpiece materials	Cutting speed Vc (m/min)	Minimum bore diameter: DMIN (mm)								
			ø8	ø10	ø12	ø14	ø16	ø18	ø20	ø25	ø32
P	Low carbon steel Carbon steel	50 - 180	0.02 - 0.05	0.02 - 0.05	0.02 - 0.07	0.01 - 0.075	0.01 - 0.08	0.05 - 0.13	0.05 - 0.13	0.05 - 0.14	0.05 - 0.14
M	Stainless steel	50 - 160	0.02 - 0.05	0.02 - 0.05	0.02 - 0.07	0.01 - 0.075	0.01 - 0.08	0.05 - 0.13	0.05 - 0.13	0.05 - 0.14	0.05 - 0.14
K	Cast iron	50 - 180	0.02 - 0.05	0.02 - 0.05	0.02 - 0.07	0.01 - 0.075	0.01 - 0.08	0.05 - 0.13	0.05 - 0.13	0.05 - 0.14	0.05 - 0.14
N	Aluminium alloys	100 - 300	0.02 - 0.05	0.02 - 0.05	0.02 - 0.07	0.01 - 0.075	0.01 - 0.08	0.05 - 0.13	0.05 - 0.13	0.05 - 0.14	0.05 - 0.14

Internal turning

ISO	Workpiece materials	Cutting speed Vc (m/min)	Minimum bore diameter: DMIN (mm)								
			ø8	ø10	ø12	ø14	ø16	ø18	ø20	ø25	ø32
P	Low carbon steel Carbon steel	50 - 180	Depth of cut: ap (mm)								
			0.2 - 2.5	0.5 - 3	0.5 - 3.5	0.5 - 4.5	0.5 - 5	0.5 - 5.5	0.5 - 6	0.5 - 6.5	0.5 - 7
			Feed: f (mm/rev)								
			0.02 - 0.12	0.05 - 0.2	0.05 - 0.2	0.05 - 0.2	0.05 - 0.2	0.1 - 0.3	0.1 - 0.3	0.1 - 0.3	0.1 - 0.4

ISO	Workpiece materials	Cutting speed Vc (m/min)	Minimum bore diameter: DMIN (mm)								
			ø8	ø10	ø12	ø14	ø16	ø18	ø20	ø25	ø32
M	Stainless steel	50 - 160	Depth of cut: ap (mm)								
			0.2 - 2.5	0.5 - 3	0.5 - 3.5	0.5 - 4.5	0.5 - 5	0.5 - 5.5	0.5 - 6	0.5 - 6.5	0.5 - 7
			Feed: f (mm/rev)								
			0.02 - 0.12	0.05 - 0.2	0.05 - 0.2	0.05 - 0.2	0.05 - 0.2	0.1 - 0.3	0.1 - 0.3	0.1 - 0.3	0.1 - 0.4

ISO	Workpiece materials	Cutting speed Vc (m/min)	Minimum bore diameter: DMIN (mm)								
			ø8	ø10	ø12	ø14	ø16	ø18	ø20	ø25	ø32
K	Cast iron	50 - 180	Depth of cut: ap (mm)								
			0.2 - 2.5	0.5 - 3	0.5 - 3.5	0.5 - 4.5	0.5 - 5	0.5 - 5.5	0.5 - 6	0.5 - 6.5	0.5 - 7
			Feed: f (mm/rev)								
			0.02 - 0.12	0.05 - 0.2	0.05 - 0.2	0.05 - 0.2	0.05 - 0.2	0.1 - 0.3	0.1 - 0.3	0.1 - 0.3	0.1 - 0.4

ISO	Workpiece materials	Cutting speed Vc (m/min)	Minimum bore diameter: DMIN (mm)								
			ø8	ø10	ø12	ø14	ø16	ø18	ø20	ø25	ø32
N	Aluminium alloys	100 - 300	Depth of cut: ap (mm)								
			0.2 - 2.5	0.5 - 3	0.5 - 3.5	0.5 - 4.5	0.5 - 5	0.5 - 5.5	0.5 - 6	0.5 - 6.5	0.5 - 7
			Feed: f (mm/rev)								
			0.02 - 0.12	0.05 - 0.2	0.05 - 0.2	0.05 - 0.2	0.05 - 0.2	0.1 - 0.3	0.1 - 0.3	0.1 - 0.3	0.1 - 0.4

Tungaloy Corporation (Head office)

11-1 Yoshima-Kogyodanchi
Iwaki-city, Fukushima 970-1144 Japan
Phone: +81-246-36-8501
Fax: +81-246-36-8542
www.tungaloy.co.jp

Tungaloy-NTK America Inc.

3726 N Ventura Drive
Arlington Heights, IL 60004, U.S.A.
Phone: +1-888-554-8394
Fax: +1-888-554-8392
www.tungaloy.com/us

Tungaloy Canada

432 Elgin St. Unit 3
Brantford, Ontario N3S 7P7, Canada
Phone: +1-519-758-5779
Fax: +1-519-758-5791
www.tungaloy.com/ca

Tungaloy-NTK De Mexico S.A.

C. Los Arellano 113,
Parque Industrial Siglo XXI
Aguascalientes, AGS, Mexico 20290
Phone: +52-449-929-5410
Fax: +52-449-929-5411
www.tungaloy.com/mx

Tungaloy-NTK do Brasil Ltda.

Avd. Independencia N4158 Residencial Flora
13280-000 Vinhedo, São Paulo, Brasil
Phone: +55-19-38262757
Fax: +55-19-38262757
www.tungaloy.com/br

Tungaloy-NTK Germany GmbH.

Katzbergstr. 3a
D-40764 Langenfeld, Germany
Phone: +49-2173-90420-0
Fax: +49-2173-90420-19
www.tungaloy.com/de

Tungaloy France s.a.s

Les Fjords
19 avenue de Norvège
91140 Villebon Sur Yvette, France
Phone: +33-1-6486-4300
Fax: +33-1-6907-7817
www.tungaloy.com/fr

Tungaloy Italia S.r.l.

Via E. Andolfato 10
I-20126 Milano, Italy
Phone: +39-02-252012-1
Fax: +39-02-252012-65
www.tungaloy.com/it

Tungaloy Czech s.r.o.

Turanka 115
CZ-627 00 Brno, Czech Republic
Phone: +420-532 123 391
Fax: +420-532 123 392
www.tungaloy.com/cz

Tungaloy Ibérica S.L.

C/Miquel Servet, 43B, Nau 7
Pol. Ind. Bufalvent
ES-08243 Manresa (BCN), Spain
Phone: +34 93 113 1360
www.tungaloy.com/es

Tungaloy Scandinavia AB

Bultgatan 38
442 40 Kungälv, Sweden
Phone: +46-462119200
Fax: +46-462119207
www.tungaloy.com/se

Tungaloy Rus, LLC

Andropova avenue, h.18/7,
11 floor, office 3, 115432,
Moscow, Russia
Phone: +7-499-683-01-80
Fax: +7-499-683-01-81
www.tungaloy.com/ru

Tungaloy Polska Sp. z o.o.

Ul. Irysowa 1, 55-040 Bielany
Wroclawskie, Poland
Phone: +48 607 907 237
www.tungaloy.com/pl

Tungaloy-NTK UK Ltd.

Suite 3, Pioneer House, Mill Street,
Cannock, WS11 0EF, UK
Phone: +44 121 4000 231
Fax: +44 121 270 9694
www.tungaloy.com/uk

Tungaloy Hungary Kft

Erzsébet királyné útja 125
H-1142 Budapest, Hungary
Phone: +36 1 781-6846
Fax: +36 1 781-6866
www.tungaloy.com/hu

Tungaloy Turkey

Serifali Mah.bayraktar Bulvari Kule Sk. No:26
34775 Umraniye / Istanbul / Turkey
Phone: +90 216 540 04 67
Fax: +90 216 540 04 87
www.tungaloy.com/tr

Tungaloy Benelux b.v.

Tjalk 70
NL-2411 NZ Bodegraven, Netherlands
Phone: +31 172 630 420
Fax: +31 172 630 429
www.tungaloy.com/nl

Tungaloy Croatia

Ulica bana Josipa Jelačića 87,
10430, Samobor, Croatia
Phone: +385 1 3326 604
Fax: +385 1 3327 683
www.tungaloy.com/hr

Tungaloy Cutting Tool (Shanghai) Co. Ltd.

Rm No 401 No.88 Zhabei
Jiangchang No.3 Rd
Shanghai 200436, China
Phone: +86-21-3632-1880
Fax: +86-21-3621-1918
www.tungaloy.com/cn

Tungaloy Cutting Tools Taiwan Co. Ltd.

9F, No.293, Zhongyang Rd,
Xinzhuang Dist, New Taipei City,
24251 Taiwan
Phone: +886-2-8521-9986
Fax: +886-2-8521-8935
www.tungaloy.com/tw

Tungaloy-NTK Cutting Tool (Thailand) Co.,Ltd.

Interlink tower 4th Fl.
1858/5-7 Bangna-Trad Road
km.5 Bangna, Bangna, Bangkok 10260
Thailand
Phone: +66-2-751-5711
Fax: +66-2-751-5715
www.tungaloy.com/th

Tungaloy Singapore (Pte.), Ltd.

62 Ubi Road 1, #06-11 Oxley BizHub 2
Singapore 408734
Phone: +65-6391-1833
Fax: +65-6299-4557
www.tungaloy.com/sg

Tungaloy-NTK Vietnam LLC

3rd Floor, Licogi 13 Tower, 164 Khuat Duy
Tien, Nhan Chinh, Thanh Xuan District,
Hanoi, Vietnam
Phone: +84 24 63282086
www.tungaloy.com/vn

Tungaloy India Pvt. Ltd.

One International Center,
Unit # 902-A, 9th Floor,
Tower 1, Senapati Bapat Marg,
Elphinstone Road (West),
Mumbai 400013, India
Phone: +91-22-6124-8803
Fax: +91-22-6124-8899
www.tungaloy.com/in

Tungaloy Korea Co., Ltd

#1312, Byucksan Digital Valley 5-cha
Beotkkot-ro 244, Geumcheon-gu
153-788 Seoul, Korea
Phone: +82-2-2621-6161
Fax: +82-2-6393-8952
www.tungaloy.com/kr

Tungaloy Malaysia Sdn Bhd

50 K-2, Kelana Mall, Jalan SS6/14
Kelana Jaya, 47301
Petaling Jaya, Selangor Darul Ehsan
Malaysia
Phone: +603-7805-3222
Fax: +603-7804-8563
www.tungaloy.com/my

Tungaloy Australia Pty Ltd

Unit 68 1470 Ferntree Gully Road
Knoxfield 3180 Victoria, Australia
Phone: +61-3-9755-8147
Fax: +61-3-9755-6070
www.tungaloy.com/au

PT. Tungaloy Indonesia

Ruko Blok AA.10 No3&5, Grand Wisata,
Lambangjaya, Tambun Selatan, Bekasi,
17510 Indonesia
Phone: +62-21-8261-5808
Fax: +62-21-8261-5809
www.tungaloy.com/id



tungaloy.com

follow us at:

facebook.com/tungaloyjapan

twitter.com/tungaloyjapan

www.youtube.com/tungaloycorporation

Distributed by:



Tungaloy APP & SNS

FIND US ON THE CLOUD!
machingcloud.com



AS9100 Certified
78006
2015.11.04
ISO 14001 Certified
EC97J1123
1997.11.26