

DrillLine



DEEPT^{RI}DRILL

www.tungaloy.de

Tungaloy Report TG0421-430-D2

Bemerkenswerte Produktivität und Stabilität beim Tieflochbohren!



INDUSTRY 4.0
FEED the SPEED!

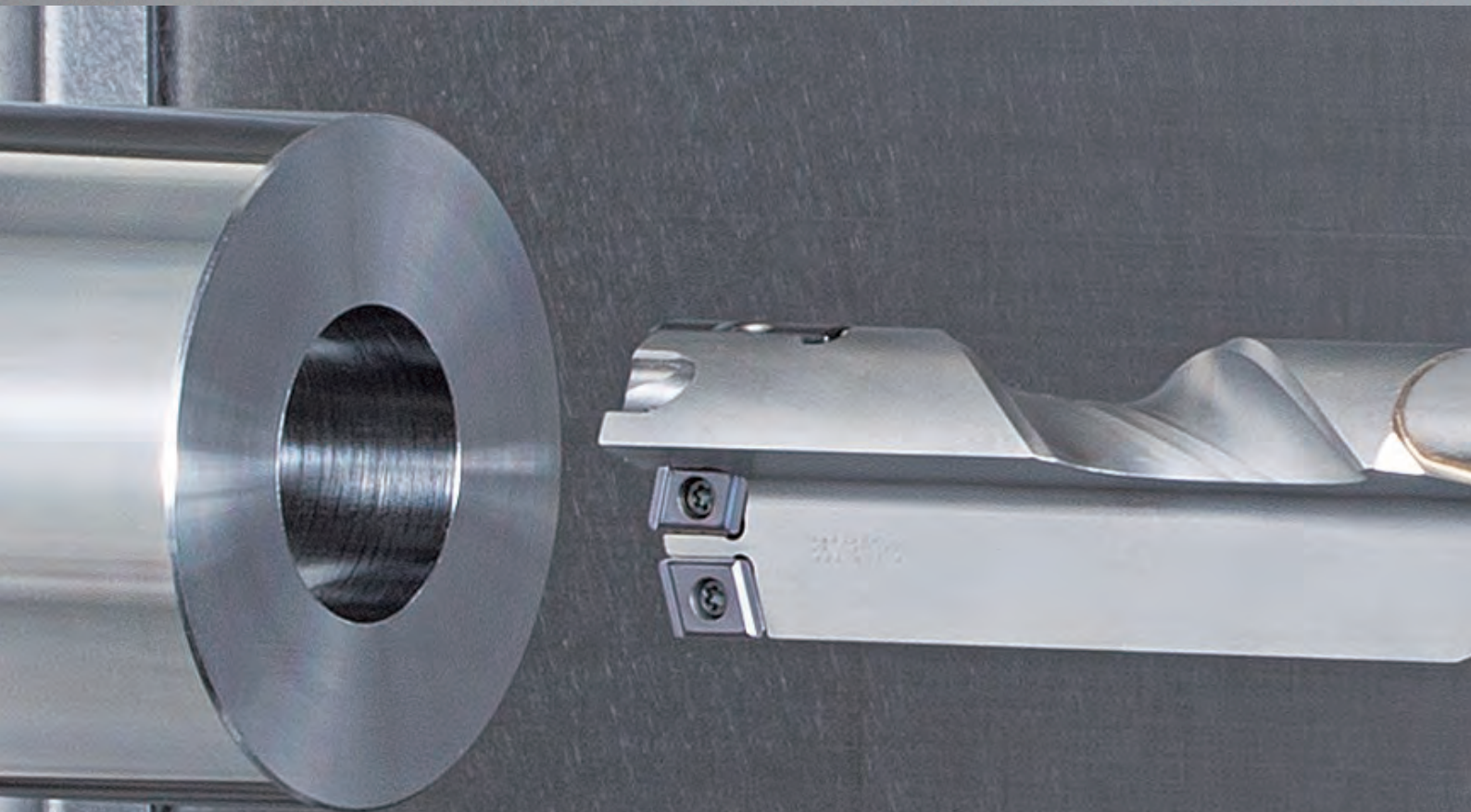
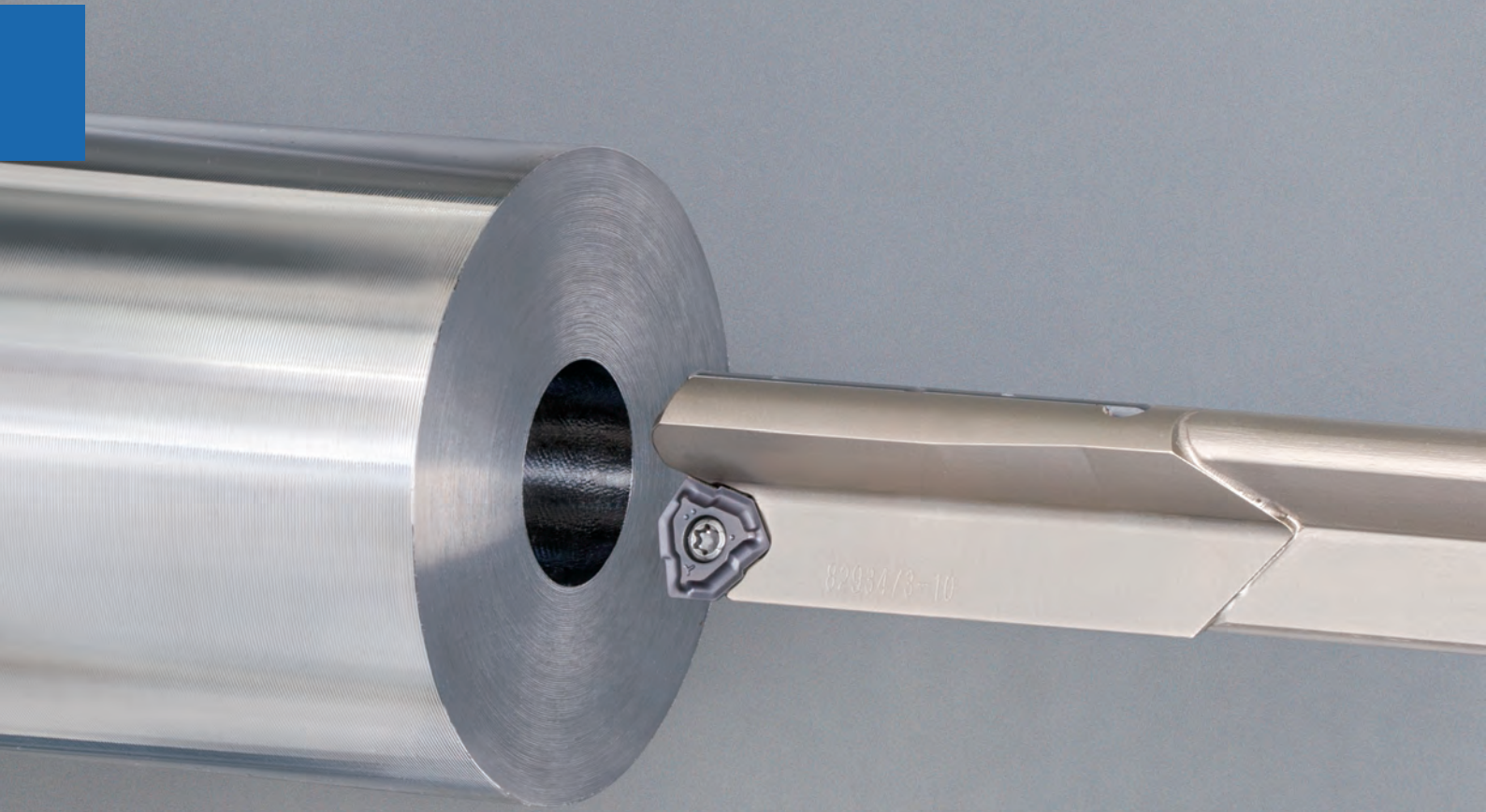

ACCELERATED MACHINING



DeepTri-Drill, **die einfach zu handhabende Tieflochbohrer Serie**, mit austauschbaren Wendeschneidplatten liefert außergewöhnlich hohe Leistung und Stabilität

DeepTri-Drill Wendeplatten-Bohrer mit außergewöhnlicher Effizienz jetzt auch mit kleineren Durchmessern

Große Auswahl für verschiedenste Tieflochbohrungen

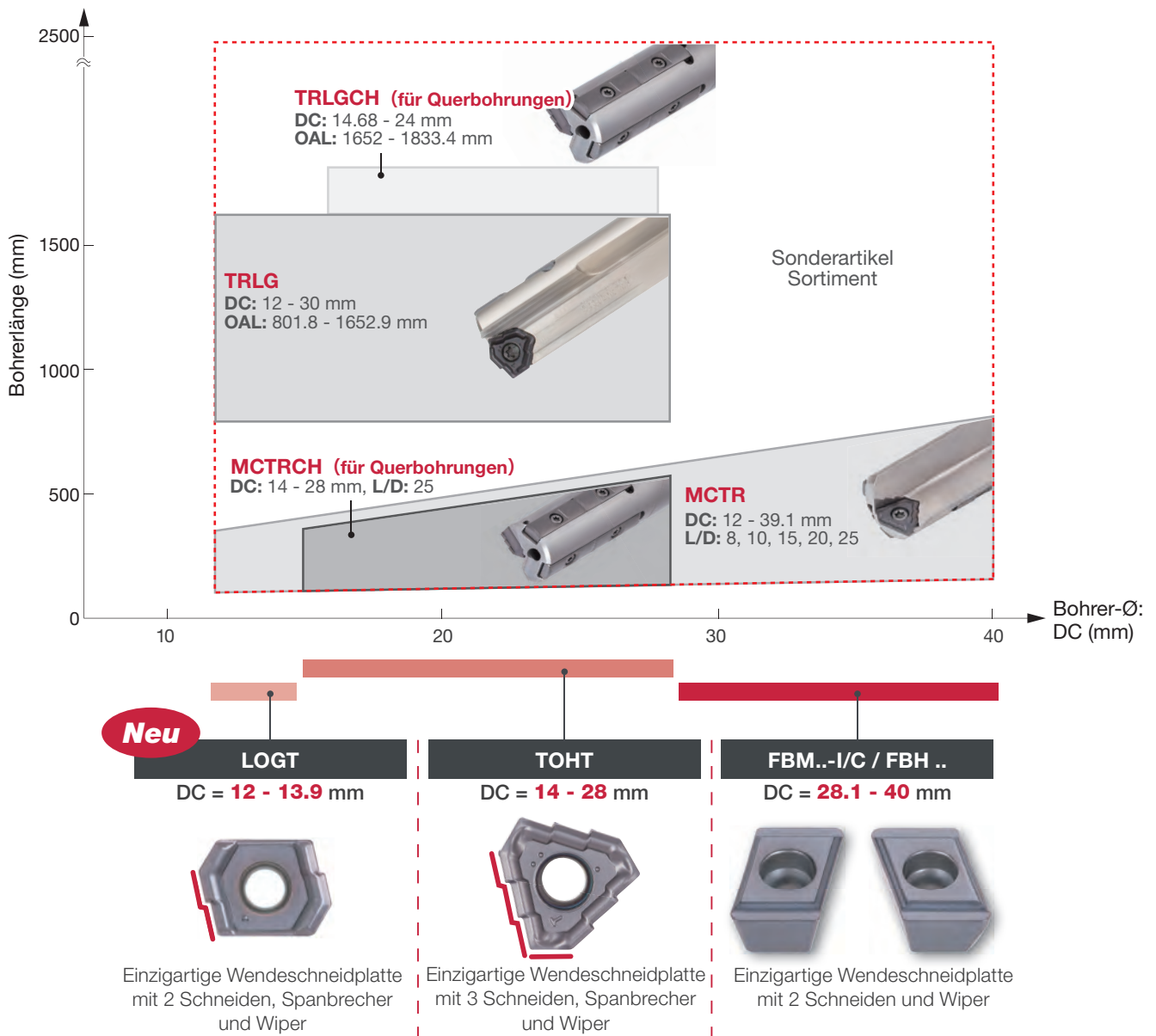

Höchste Effizienz

- Einzigartige **Spanformstufe** und **Spanbrecher** an der Schneide ermöglicht eine beeindruckende Spankontrolle bei jeder Vorschubgeschwindigkeit, insbesondere bei höheren Vorschüben

■ **Leistungsvergleich**
Gelöteter Einlippenbohrer und Wendepplattenbohrer

P C55

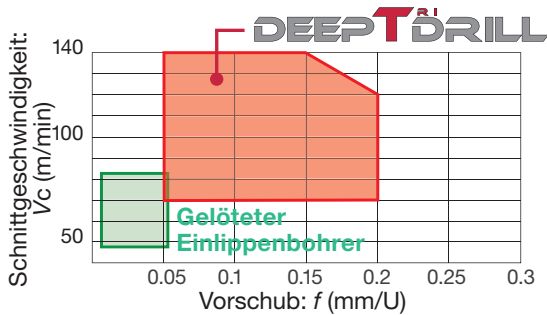

- Dank der reibungslosen Späneabfuhr ist das Tieflochbohren (Bohren) auch bei einem Standard-Kühlmitteldruck von 1-2 MPa (145-290 psi)

■ **Spanform**

P C55

Bohrer-Ø: DC = 21 mm



Schnittgeschwindigkeit : $V_c = 100$ m/min
Vorschub : $f = 0.15$ mm/U



Schnittgeschwindigkeit : $V_c = 60$ m/min
Vorschub : $f = 0.05$ mm/U

Exzellente Rundheit, Geradheit, und Oberflächengüte

Speziell geschliffene Wendeschneidplatten in Verbindung mit optimierten Führungsleisten liefern hohe Bohrlochgenauigkeit.

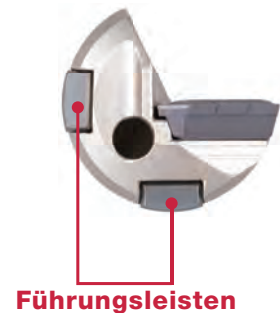

Rundheit

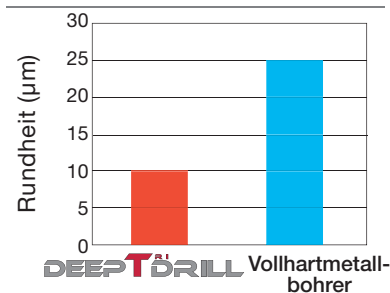

Werkstoff : 42CrMo4
Schnittgeschw.: $V_c = 100$ m/min
Vorschub : $f = 0.2$ mm/U

Geradheit

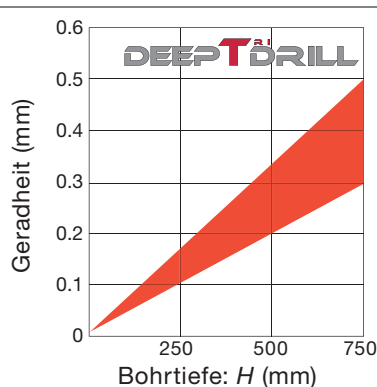

Oberflächengüte

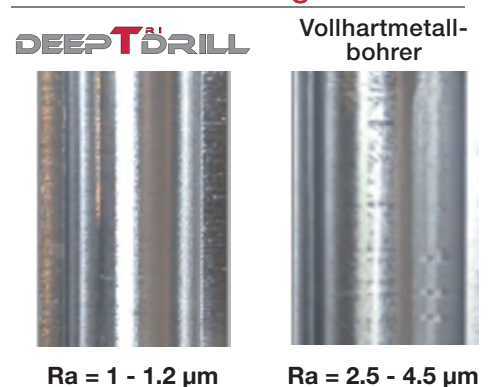

MCTR L/D=8

Für Drehmaschinen und Bearbeitungszentren, L/D = 8, Werkzeug-Ø 33.1, 39.1 mm

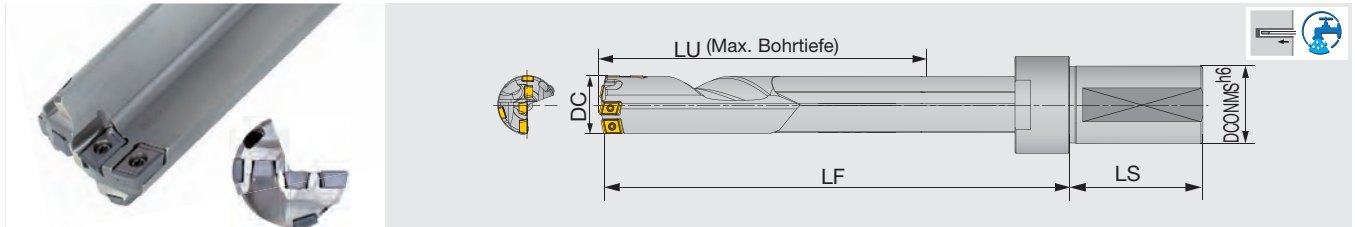

Katalog Nr.	DC	DCONMS	LU	LS	LF	Wendeschneidplatte	Führungsleiste
MCTR33.10XFM40-8	33.1	40	275	69	350	FBM06**-C, FBM06**-I, FBH07**-P	GP07
MCTR39.10XFM40-8	39.1	40	323	69	407	FBM08**-C, FBM06**-I, FBH09**-P	GP08

DC	Werkzeug-Ø Toleranz	Bohrungs-Ø Toleranz
33.1, 39.1	0 / - 0.07	+ 0.05 / - 0.1

Max. DC = 40: Verfügbare Sonderanfertigungen

AUSTAUSCHTEILE



Katalog Nr.	Wendeschneidplatte				Führungsleiste			
	Zentrum		Mitte		Außen			
	Schraube	Schlüssel	Schraube	Schlüssel	Schraube	Schlüssel		
MCTR33.1..., MCTR39.1...	CSTB-2.5	T-8F	CSTB-2.5	T-8F	CSTB-2.5	T-8F	CSTB-3S	T-9F

Empf. Drehmoment (N·m) für Klemmung: CSTB2.5=1.3, CSTB-3S=2.3

Hinweis: Bohrer im Bereich der Spanablaufzone brüniert. Die fertige Oberfläche kann uneben erscheinen. Dies hat keine Auswirkungen auf die Bohrerleistung.

MCTR L/D=10

Für Drehmaschinen und Bearbeitungszentren, L/D = 10, Werkzeug-Ø 16 - 28 mm

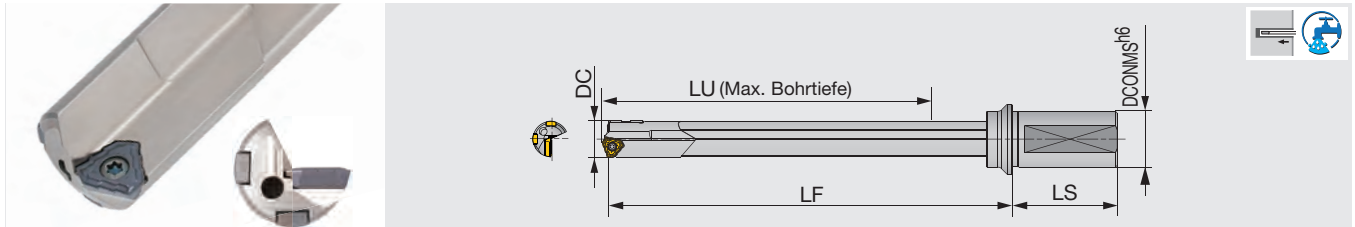

Katalog Nr.	DC	DCONMS	LU	LS	LF	Wendeschneidplatte	Führungsleiste
MCTR16.00XM25A-10	16	25	172.2	56	209	TOHT08...	GP05-075
MCTR16.50XM25A-10	16.5	25	172.2	56	209	TOHT08...	GP05-075
MCTR17.00XM25A-10	17	25	182.2	56	220	TOHT08...	GP05-075
Neu MCTR17.45XU25.4A-10	17.45	25.4	182.2	56	220	TOHT08..	GP05-075
MCTR18.00XM25A-10	18	25	192.2	56	232	TOHT08...	GP05-075
Neu MCTR18.24XU25.4-10	18.24	25.4	193	56	232	TOHT09..	GP06-085
Neu MCTR18.64XU25.4-10	18.64	25.4	193	56	232	TOHT09..	GP06-085
MCTR19.00XM25-10	19	25	203	56	243	TOHT09...	GP06-085
Neu MCTR19.05XU25.4-10	19.05	25.4	203	56	243	TOHT09..	GP06-085
Neu MCTR19.94XU31.75-10	19.94	31.75	213	60	255	TOHT09..	GP06-085
MCTR20.00XM32-10	20	32	213	60	255	TOHT09...	GP06-085
Neu MCTR20.62XU31.75-10	20.62	31.75	213.2	60	255	TOHT10..	GP06-085
MCTR21.00XM32-10	21	32	223.2	60	266	TOHT10...	GP06-085
MCTR22.00XM32-10	22	32	233.4	60	278	TOHT11...	GP06-100
Neu MCTR22.23XU31.75-10	22.23	31.75	233.4	60	278	TOHT11..	GP06-100
MCTR23.00XM32-10	23	32	243.4	60	289	TOHT11...	GP06-100
Neu MCTR23.80XU31.75-10	23.8	31.75	253.4	60	301	TOHT11..	GP06-100
MCTR24.00XM32-10	24	32	253.4	60	301	TOHT11...	GP06-100
MCTR25.00XM32-10	25	32	263.4	60	312	TOHT11...	GP06-100
Neu MCTR25.40XU31.75-10	25.4	31.75	263.7	60	312	TOHT12..	GP06
MCTR26.00XM40-10	26	40	273.7	70	324	TOHT12...	GP06
Neu MCTR26.97XU31.75X-10	26.97	31.75	283.7	60	335	TOHT12..	GP06
MCTR27.00XM40-10	27	40	283.7	70	335	TOHT12...	GP06
MCTR28.00XM40-10	28	40	283.7	70	337	TOHT12...	GP06

DC	Werkzeug-Ø Toleranz	Bohrungs-Ø Toleranz
16 - 28	0 / - 0.07	+ 0.05 / - 0.1

AUSTAUSCHTEILE

Katalog Nr.	Wendeschneidplatte		Führungsleiste	
	Schraube	Schlüssel	Schraube	Schlüssel
MCTR16... - MCTR20.00...	SR14-560/S	T-8F	SR34-508	T-7F
MCTR20.62... - MCTR21...	SR34-506	T-9F	SR34-508	T-7F
MCTR22... - MCTR25.00...	SR14-571/S	T-10/5	SR34-508	T-7F
MCTR25.4... - MCTR28...	SR14-506	T-15F	SR34-508	T-7F

Empf. Drehmoment (N·m) für Klemmung: SR34-506=0.9, SR34-508=0.9, SR14-560/S=1.2, SR14-571/S=3.2, SR14-506=4.8

Wendeschneidplatten → **S. 23** Führungsleisten → **S. 25**

MCTR L/D=10

Für Drehmaschinen und Bearbeitungszentren, L/D = 10, Werkzeug-Ø 28.58 - 38.1 mm

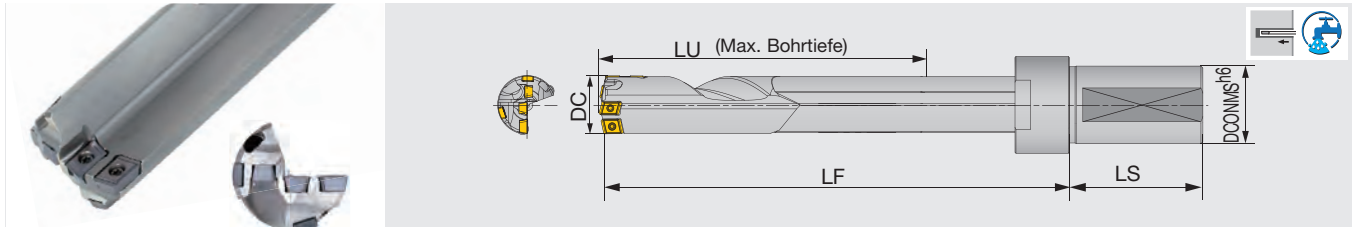

	Katalog Nr.	DC	DCONMS	LU	LS	LF	Wendeschneidplatte	Führungsleiste
Neu	MCTR28.58XFU31.75-10	28.58	31.75	292.6	69	360	FBM06**-C, FBM05**-I, FBH06**-P	GP06
	MCTR29.00XFM40-10	29	40	292.6	69	360	FBM06**-C, FBM05**-I, FBH06**-P	GP06
	MCTR30.00XFM40-10	30	40	312.9	69	383	FBM06**-C, FBM06**-I, FBH07**-P	GP06
	MCTR31.00XFM40-10	31	40	312.9	69	383	FBM06**-C, FBM06**-I, FBH07**-P	GP06
Neu	MCTR31.75XFU31.75-10	31.75	31.75	323	69	395	FBM06**-C, FBM06**-I, FBH07**-P	GP06
	MCTR32.00XFM40-10	32	40	323	69	395	FBM06**-C, FBM06**-I, FBH07**-P	GP06
	MCTR33.00XFM40-10	33	40	333.1	69	406	FBM06**-C, FBM06**-I, FBH07**-P	GP06
	MCTR34.00XFM40-10	34	40	343	69	418	FBM06**-C, FBM06**-I, FBH07**-P	GP07
Neu	MCTR34.93XFU31.75-10	34.93	31.75	353.1	69	428	FBM06**-C, FBM06**-I, FBH07**-P	GP07
	MCTR35.00XFM40-10	35	40	353.1	69	428	FBM06**-C, FBM06**-I, FBH07**-P	GP07
	MCTR36.00XFM40-10	36	40	363.1	69	441	FBM08**-C, FBM06**-I, FBH07**-P	GP07
Neu	MCTR38.10XFU31.75-10	38.1	31.75	393.4	69	474	FBM08**-C, FBM06**-I, FBH09**-P	GP08

DC	Werkzeug-Ø Toleranz	Bohrungs-Ø Toleranz
28.58 - 38.1	0 / - 0.07	+ 0.05 / - 0.1

Max. DC = 40: Verfügbare Sonderanfertigungen

AUSTAUSCHTEILE

Katalog Nr.	Wendeschneidplatte						Führungsleiste	
	Zentrum		Mitte		Außen		Schraube	Schlüssel
	Schraube	Schlüssel	Schraube	Schlüssel	Schraube	Schlüssel		
MCTR28.58... - MCTR29...	CSTB-2.5	T-8F	CSTB-2.2	T-7F	CSTB-2.2	T-7F	SR34-508	T-7F
MCTR30... - MCTR33...	CSTB-2.5	T-8F	CSTB-2.5	T-8F	CSTB-2.5	T-8F	SR34-508	T-7F
MCTR34... - MCTR38.1...	CSTB-2.5	T-8F	CSTB-2.5	T-8F	CSTB-2.5	T-8F	CSTB-3S	T-9F

Empf. Drehmoment (N·m) für Klemmung: SR34-508=0.9, CSTB-2.2=1, CSTB-2.5=1.3, CSTB-3S=2.3,

Hinweis: Bohrer im Bereich der Spanablaufzone brüniert. Die fertige Oberfläche kann uneben erscheinen.

Dies hat keine Auswirkungen auf die Bohrerleistung.

MCTR L/D=15

Für Drehmaschinen und Bearbeitungszentren, L/D = 15, Werkzeug-Ø 12 - 28 mm

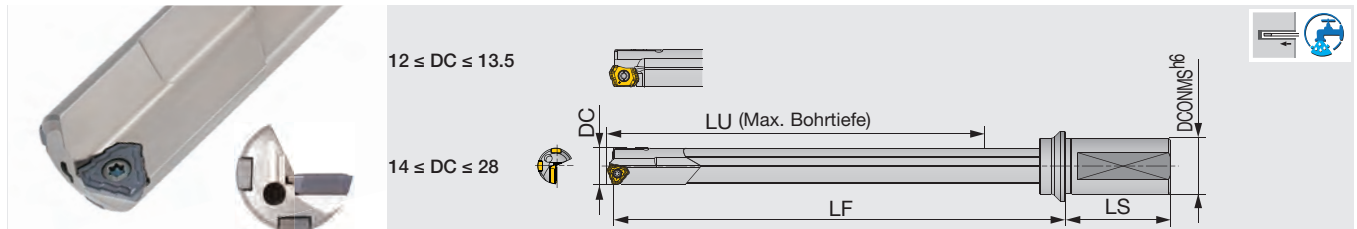

	Katalog Nr.	DC	DCONMS	LU	LS	LF	Wendeschneidplatte	Führungsleiste
Neu	MCTR12.00XM20-15	12	20	196.8	50	225	LOGT06...	GP04-055
Neu	MCTR12.50XM20-15	12.5	20	196.8	50	226	LOGT06...	GP04-055
Neu	MCTR12.70XU25.4-15	12.7	25.4	196.8	56	229	LOGT06..	GP04-055
Neu	MCTR13.00XM25-15	13	25	211.8	56	245	LOGT06...	GP04-055
Neu	MCTR13.49XU25.4-15	13.49	25.4	211.8	56	245	LOGT06..	GP04-055
Neu	MCTR13.50XM25-15	13.5	25	211.8	56	245	LOGT06...	GP04-055
	MCTR14.00XM25-15	14	25	227	56	245	TOHT07...	GP05-060
Neu	MCTR14.27XU25.4-15	14.27	25.4	227	56	261	TOHT07..	GP05-060
	MCTR14.50XM25-15	14.5	25	227	56	262	TOHT07...	GP05-060
	MCTR15.00XM25-15	15	25	242	56	278	TOHT07...	GP05-060
Neu	MCTR15.88XU25.4-15	15.88	25.4	242	56	279	TOHT07..	GP05-060
	MCTR16.00XM25A-15	16	25	257.2	56	294	TOHT08...	GP05-075
	MCTR16.50XM25A-15	16.5	25	257.2	56	294	TOHT08...	GP05-075
	MCTR17.00XM25A-15	17	25	272.2	56	310	TOHT08...	GP05-075
Neu	MCTR17.45XU25.4A-15	17.45	25.4	272.2	56	310	TOHT08..	GP05-075
	MCTR17.50XM25A-15	17.5	25	272.2	56	310	TOHT08...	GP05-075
	MCTR18.00XM25A-15	18	25	287.2	56	327	TOHT08...	GP05-075
Neu	MCTR18.24XU25.4-15	18.24	25.4	288	56	327	TOHT09..	GP06-085
	MCTR18.50XM25-15	18.5	25	288	56	327	TOHT09...	GP06-085
Neu	MCTR18.64XU25.4-15	18.64	25.4	288	56	327	TOHT09..	GP06-085
	MCTR19.00XM25-15	19	25	303	56	343	TOHT09...	GP06-085
Neu	MCTR19.05XU25.4-15	19.05	25.4	303	56	343	TOHT09..	GP06-085
	MCTR19.50XM25-15	19.5	25	303	56	343	TOHT09...	GP06-085
Neu	MCTR19.94XU31.75-15	19.94	31.75	318	60	360	TOHT09..	GP06-085
	MCTR20.00XM32-15	20	32	318	60	360	TOHT09...	GP06-085
Neu	MCTR20.62XU31.75-15	20.62	31.75	318.2	60	360	TOHT10..	GP06-085
	MCTR21.00XM32-15	21	32	333.2	60	376	TOHT10...	GP06-085
	MCTR22.00XM32-15	22	32	348.4	60	393	TOHT11...	GP06-100
Neu	MCTR22.23XU31.75-15	22.23	31.75	348.4	60	393	TOHT11..	GP06-100
	MCTR23.00XM32-15	23	32	363.4	60	409	TOHT11...	GP06-100
Neu	MCTR23.80XU31.75-15	23.8	31.75	378.4	60	426	TOHT11..	GP06-100
	MCTR24.00XM32-15	24	32	378.4	60	426	TOHT11...	GP06-100
	MCTR25.00XM32-15	25	32	393.4	60	442	TOHT11...	GP06-100
Neu	MCTR25.40XU31.75-15	25.4	31.75	393.7	60	442	TOHT12..	GP06
	MCTR26.00XM40-15	26	40	408.7	70	459	TOHT12...	GP06
Neu	MCTR26.97XU31.75X-15	26.97	31.75	423.7	60	475	TOHT12..	GP06
	MCTR27.00XM40-15	27	40	423.7	70	475	TOHT12...	GP06
	MCTR28.00XM40-15	28	40	423.7	70	477	TOHT12...	GP06

DC	Werkzeug-Ø Toleranz	Bohrungs-Ø Toleranz
12 - 28	0 / - 0.07	+ 0.05 / - 0.1

AUSTAUSCHTEILE



Katalog Nr.	Wendeschneidplatte		Führungsleiste	
	Schraube	Schlüssel	Schraube	Schlüssel
MCTR12... - MCTR13.5...	SR10503833L040	T-7F	CSPB-2L043	IP-6F
MCTR14... - MCTR20.00...	SR14-560/S	T-8F	SR34-508	T-7F
MCTR20.62... - MCTR21...	SR34-506	T-9F	SR34-508	T-7F
MCTR22... - MCTR25.00...	SR14-571/S	T-10/5	SR34-508	T-7F
MCTR25.4... - MCTR28...	SR14-506	T-15F	SR34-508	T-7F

Empf. Drehmoment (N·m) für Klemmung: CSPB-2L043=0.7, SR34-506=0.9, SR34-508=0.9, SR14-560/S=1.2, SR10503833L040=1.3, SR14-571/S=3.2, SR14-506=4.8

MCTR-F L/D=15

Für Drehmaschinen und Bearbeitungszentren, L/D = 15, Werkzeug-Ø 28.58 - 38.1 mm

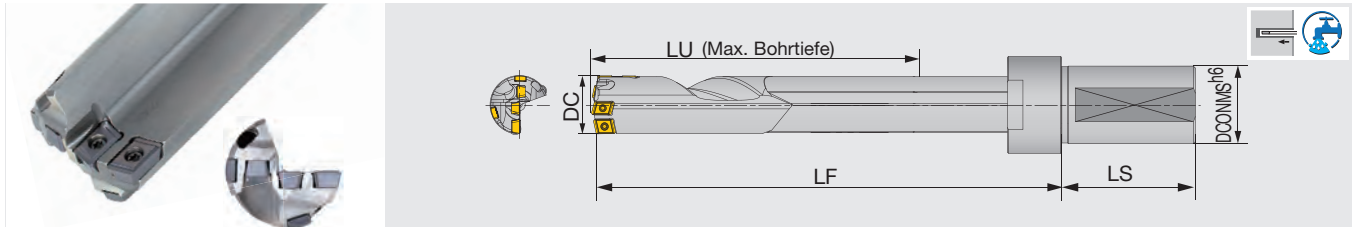

	Katalog Nr.	DC	DCONMS	LU	LS	LF	Wendeschneidplatte	Führungsleiste
Neu	MCTR28.58XFU31.75-15	28.58	31.75	437.6	69	505	FBM06**-C, FBM05**-I, FBH06**-P	GP06
	MCTR29.00XFM40-15	29	40	437.6	69	505	FBM06**-C, FBM05**-I, FBH06**-P	GP06
	MCTR30.00XFM40-15	30	40	467.9	69	538	FBM06**-C, FBM06**-I, FBH07**-P	GP06
	MCTR31.00XFM40-15	31	40	467.9	69	538	FBM06**-C, FBM06**-I, FBH07**-P	GP06
Neu	MCTR31.75XFU31.75-15	31.75	31.75	483	69	555	FBM06**-C, FBM06**-I, FBH07**-P	GP06
	MCTR32.00XFM40-15	32	40	483	69	555	FBM06**-C, FBM06**-I, FBH07**-P	GP06
	MCTR33.00XFM40-15	33	40	498.1	69	571	FBM06**-C, FBM06**-I, FBH07**-P	GP06
	MCTR34.00XFM40-15	34	40	513	69	588	FBM06**-C, FBM06**-I, FBH07**-P	GP07
Neu	MCTR34.93XFU31.75-15	34.93	31.75	528.1	69	603	FBM06**-C, FBM06**-I, FBH07**-P	GP07
	MCTR35.00XFM40-15	35	40	528.1	69	603	FBM06**-C, FBM06**-I, FBH07**-P	GP07
	MCTR36.00XFM40-15	36	40	543.1	69	621	FBM08**-C, FBM06**-I, FBH07**-P	GP07
Neu	MCTR38.10XFU31.75-15	38.1	31.75	588.4	69	669	FBM08**-C, FBM06**-I, FBH09**-P	GP08

DC	Werkzeug-Ø Toleranz	Bohrungs-Ø Toleranz
28.58 - 38.1	0 / - 0.07	+ 0.05 / - 0.1

Max. DC = 40: Verfügbare Sonderanfertigungen

AUSTAUSCHTEILE



Katalog Nr.	Wendeschneidplatte						Führungsleiste	
	Zentrum		Mitte		Außen		Schraube	Schlüssel
	Schraube	Schlüssel	Schraube	Schlüssel	Schraube	Schlüssel	Schraube	Schlüssel
MCTR28.58... - MCTR29...	CSTB-2.5	T-8F	CSTB-2.2	T-7F	CSTB-2.2	T-7F	SR34-508	T-7F
MCTR30... - MCTR33...	CSTB-2.5	T-8F	CSTB-2.5	T-8F	CSTB-2.5	T-8F	SR34-508	T-7F
MCTR34... - MCTR38...	CSTB-2.5	T-8F	CSTB-2.5	T-8F	CSTB-2.5	T-8F	CSTB-3S	T-9F

Empf. Drehmoment (N·m) für Klemmung: SR34-508=0.9, CSTB-2.2=1, CSTB-2.5=1.3, CSTB-3S=2.3

Hinweis: Bohrer im Bereich der Spanablaufzone brüniert. Die fertige Oberfläche kann uneben erscheinen. Dies hat keine Auswirkungen auf die Bohrerleistung.

MCTR L/D=20

Für Drehmaschinen und Bearbeitungszentren, L/D = 20, Werkzeug-Ø 12 - 15 mm

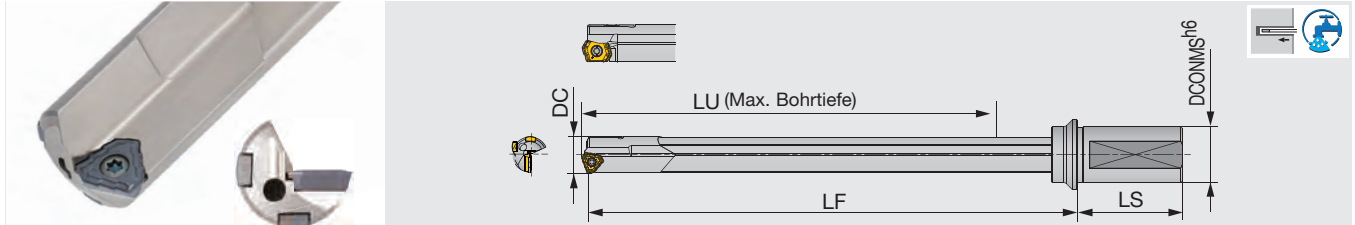

Katalog Nr.	DC	DCONMS	LU	LS	LF	Wendeschneidplatte	Führungsleiste
Neu MCTR12.00XM20-20	12	20	261.8	50	290	LOGT06...	GP04-055
Neu MCTR12.50XM20-20	12.5	20	261.8	50	291	LOGT06...	GP04-055
Neu MCTR13.00XM25-20	13	25	281.8	56	315	LOGT06...	GP04-055
Neu MCTR13.50XM25-20	13.5	25	281.8	56	315	LOGT06...	GP04-055
MCTR14.00XM25-20	14	25	302	56	336	TOHT07...	GP05-060
MCTR14.50XM25-20	14.5	25	302	56	337	TOHT07...	GP05-060
MCTR15.00XM25-20	15	25	322	56	358	TOHT07...	GP05-060

øDc	Werkzeug-Ø Toleranz	Bohrungs-Ø Toleranz
12 - 15	0 / - 0.07	+ 0.05 / - 0.1

AUSTAUSCHTEILE

Katalog Nr.	Wendeschneidplatte		Führungsleiste	
	Schraube	Schlüssel	Schraube	Schlüssel
MCTR12...-MCTR13.5...	SR10503833L040	T-7F	CSPB-2L043	IP-6F
MCTR14...-MCTR15...	SR14-560/S	T-8F	SR34-508	T-7F

Empf. Drehmoment (N·m) für Klemmung: CSPB-2L043=0.7, SR34-508=0.9, SR14-560/S=1.2, SR10503833L040=1.3

MCTR L/D=25

Für Drehmaschinen und Bearbeitungszentren, L/D = 25, Werkzeug-Ø 12 - 28 mm

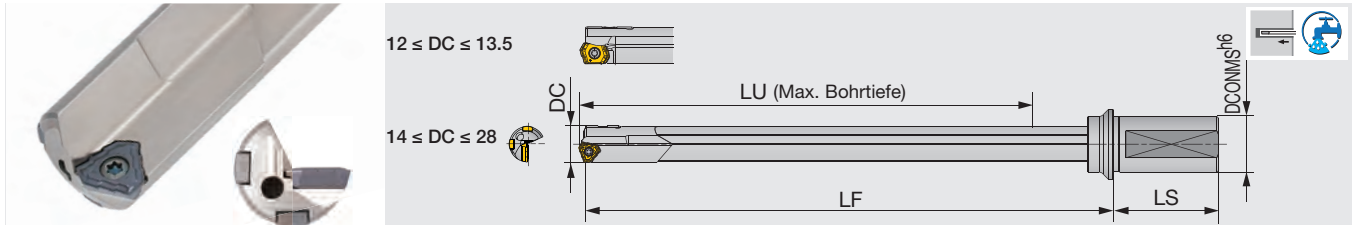

Katalog Nr.	DC	DCONMS	LU	LS	LF	Wendeschneidplatte	Führungsleiste
Neu MCTR12.00XM20-25	12	20	326.8	50	355	LOGT06...	GP04-055
Neu MCTR12.50XM20-25	12.5	20	326.8	50	356	LOGT06...	GP04-055
Neu MCTR12.70XU25.4-25	12.7	25.4	326.8	56	359	LOGT06..	GP04-055
Neu MCTR13.00XM25-25	13	25	351.8	56	385	LOGT06...	GP04-055
Neu MCTR13.49XU25.4-25	13.49	25.4	351.8	56	385	LOGT06..	GP04-055
Neu MCTR13.50XM25-25	13.5	25	351.8	56	385	LOGT06...	GP04-055
MCTR14.00XM25-25	14	25	377	56	411	TOHT07...	GP05-060
Neu MCTR14.27XU25.4-25	14.27	25.4	377	56	411	TOHT07..	GP05-060
MCTR14.50XM25-25	14.5	25	377	56	412	TOHT07...	GP05-060
MCTR15.00XM25-25	15	25	402	56	438	TOHT07...	GP05-060
Neu MCTR15.88XU25.4-25	15.88	25.4	402	56	439	TOHT07..	GP05-060
MCTR16.00XM25A-25	16	25	427.2	56	464	TOHT08...	GP05-075
MCTR16.50XM25A-25	16.5	25	427.2	56	464	TOHT08...	GP05-075
MCTR17.00XM25A-25	17	25	452.2	56	490	TOHT08...	GP05-075
Neu MCTR17.45XU25.4A-25	17.45	25.4	452.2	56	490	TOHT08..	GP05-075
MCTR17.50XM25A-25	17.5	25	452.2	56	490	TOHT08...	GP05-075
MCTR18.00XM25A-25	18	25	477.2	56	517	TOHT08...	GP05-075
Neu MCTR18.24XU25.4-25	18.24	25.4	478	56	517	TOHT09..	GP06-085
MCTR18.50XM25-25	18.5	25	478	56	517	TOHT09...	GP06-085
Neu MCTR18.64XU25.4-25	18.64	25.4	478	56	517	TOHT09..	GP06-085
MCTR19.00XM25-25	19	25	503	56	543	TOHT09...	GP06-085
Neu MCTR19.05XU25.4-25	19.05	25.4	503	56	543	TOHT09..	GP06-085
MCTR19.50XM25-25	19.5	25	503	56	543	TOHT09...	GP06-085
Neu MCTR19.94XU31.75-25	19.94	31.75	528	60	570	TOHT09..	GP06-085
MCTR20.00XM32-25	20	32	528	60	570	TOHT09...	GP06-085
Neu MCTR20.62XU31.75-25	20.62	31.75	528.2	60	570	TOHT10..	GP06-085
MCTR21.00XM32-25	21	32	553.2	60	596	TOHT10...	GP06-085
MCTR22.00XM32-25	22	32	578.4	60	623	TOHT11...	GP06-100
Neu MCTR22.23XU31.75-25	22.23	31.75	578.4	60	623	TOHT11..	GP06-100
MCTR23.00XM32-25	23	32	603.4	60	649	TOHT11...	GP06-100
Neu MCTR23.80XU31.75-25	23.8	31.75	628.4	60	676	TOHT11..	GP06-100
MCTR24.00XM32-25	24	32	628.4	60	676	TOHT11...	GP06-100
MCTR25.00XM32-25	25	32	653.4	60	702	TOHT11...	GP06-100
Neu MCTR25.40XU31.75-25	25.4	31.75	653.7	60	702	TOHT12..	GP06
MCTR26.00XM40-25	26	40	678.7	70	729	TOHT12...	GP06
Neu MCTR26.97XU31.75X-25	26.97	31.75	703.7	60	755	TOHT12..	GP06
MCTR27.00XM40-25	27	40	703.7	70	755	TOHT12...	GP06
MCTR28.00XM40-25	28	40	703.7	70	757	TOHT12...	GP06

DC	Werkzeug-Ø Toleranz	Bohrungs-Ø Toleranz
12 - 28	0 / - 0.07	+ 0.05 / - 0.1

AUSTAUSCHTEILE



Katalog Nr.	Wendeschneidplatte		Führungsleiste	
	Schraube	Schlüssel	Schraube	Schlüssel
MCTR12... - MCTR13.5...	SR10503833L040	T-7F	CSPB-2L043	IP-6F
MCTR14... - MCTR20.00...	SR14-560/S	T-8F	SR34-508	T-7F
MCTR20.62... - ...MCTR21...	SR34-506	T-9F	SR34-508	T-7F
MCTR22... - MCTR25.00...	SR14-571/S	T-10/5	SR34-508	T-7F
MCTR25.4... - MCTR28...	SR14-506	T-15F	SR34-508	T-7F

Empf. Drehmoment (N·m) für Klemmung: CSPB-2L043=0.7, SR34-506=0.9, SR34-508=0.9, SR14-560/S=1.2, SR10503833L040=1.3, SR14-571/S=3.2, SR14-506=4.8

MCTR-F L/D=25

Für Drehmaschinen und Bearbeitungszentren, L/D = 25, Werkzeug-Ø 28.58 - 38.1 mm

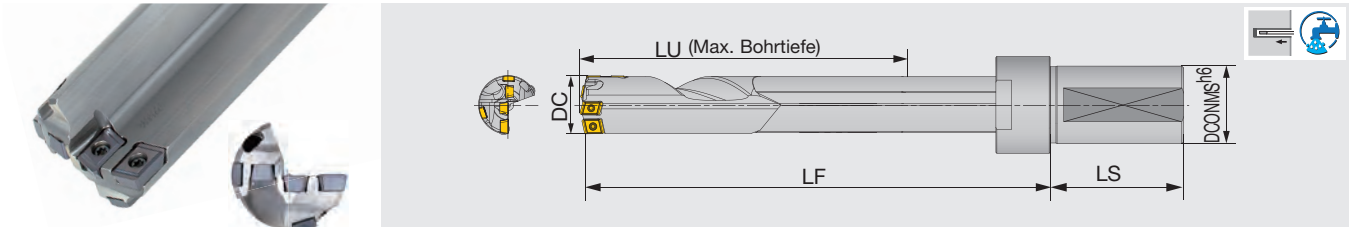

	Katalog Nr.	DC	DCONMS	LU	LS	LF	Wendeschneidplatte	Führungsleiste
Neu	MCTR28.58XFU31.75-25	28.58	31.75	727.6	69	795	FBM06**-C, FBM05**-I, FBH06**-P	GP06
	MCTR30.00XFM40-25	30	40	777.9	69	848	FBM06**-C/I, FBH07**-P	GP06
Neu	MCTR31.75XFU31.75-25	31.75	31.75	803	69	875	FBM06**-C, FBM06**-I, FBH07**-P	GP06
Neu	MCTR34.93XFU31.75-25	34.93	31.75	878.1	69	953	FBM06**-C, FBM06**-I, FBH07**-P	GP07
Neu	MCTR38.10XFU31.75-25	38.1	31.75	978.4	69	1059	FBM08**-C, FBM06**-I, FBH09**-P	GP08

DC	Werkzeug-Ø Toleranz	Bohrungs-Ø Toleranz
28.58 - 38.1	0 / - 0.07	+ 0.05 / - 0.1

Max. DC = 40: Verfügbare Sonderanfertigungen

AUSTAUSCHTEILE

Katalog Nr.	Wendeschneidplatte						Führungsleiste	
	Zentrum		Mitte		Außen		Schraube	Schlüssel
	Schraube	Schlüssel	Schraube	Schlüssel	Schraube	Schlüssel		
MCTR28...	CSTB-2.5	T-8F	CSTB-2.2	T-7F	CSTB-2.2	T-7F	SR34-508	T-7F
MCTR30... - MCTR31...	CSTB-2.5	T-8F	CSTB-2.5	T-8F	CSTB-2.5	T-8F	SR34-508	T-7F
MCTR34... - MCTR38...	CSTB-2.5	T-8F	CSTB-2.5	T-8F	CSTB-2.5	T-8F	CSTB-3S	T-9F

Empf. Drehmoment (N·m) für Klemmung: SR34-508=0.9, CSTB-2.2=1, CSTB-2.5=1.3, CSTB-3S=2.3

Hinweis: Bohrer im Bereich der Spanablaufzone brüniert. Die fertige Oberfläche kann uneben erscheinen. Dies hat keine Auswirkungen auf die Bohrerleistung.

MCTRCH L/D=25

Tieflochbohrer für Querbohrungen auf CNC Drehmaschinen und Bearbeitungszentren, L/D = 25, Werkzeug-Ø 14 mm - 28 mm

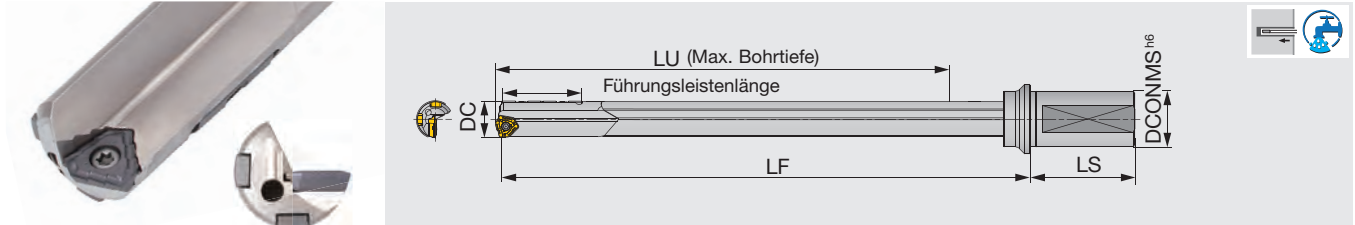

Katalog Nr.	DC	DCONMS	LU	LS	LF	Wendeschneidplatten	Führungsleisten	Führungsleistenlänge
MCTRCH14.00XM25-25	14	25	377	56	411	TOHT07...	GP05 - 060	32
MCTRCH14.68XU25.4-25	14.68	25.4	377	56	412	TOHT07...	GP05 - 060	32
MCTRCH15.00XM25-25	15	25	402	56	438	TOHT07...	GP05 - 060	32
MCTRCH15.06XU25.4-25	15.06	25.4	402	56	438	TOHT07...	GP05 - 060	32
MCTRCH16.00XM25A-25	16	25	427.2	56	464	TOHT08...	GP05 - 075	32
MCTRCH18.00XM25A-25	18	25	477.2	56	517	TOHT08...	GP05 - 075	32
MCTRCH18.24XU25.4-25	18.24	25.4	478	56	517	TOHT09...	GP06 - 085	40
MCTRCH18.64XU25.4-25	18.64	25.4	478	56	517	TOHT09...	GP06 - 085	40
MCTRCH19.00XM25-25	19	25	503	56	543	TOHT09...	GP06 - 085	40
MCTRCH20.00XM32-25	20	32	528	60	570	TOHT09...	GP06 - 085	40
MCTRCH23.00XM32-25	23	32	603.4	60	649	TOHT11...	GP06 - 100	40
MCTRCH23.80XU31.75-25	23.8	31.75	628.4	60	676	TOHT11...	GP06 - 100	40
MCTRCH24.00XM32-25	24	32	628.4	60	676	TOHT11...	GP06 - 100	40
MCTRCH28.00XM40-25	28	40	703.7	70	757	TOHT12...	GP06	40

DC	Werkzeug-Ø Toleranz	Bohrungs-Ø Toleranz
14 - 28	0 / - 0.09	+ 0.05 / - 0.12

AUSTAUSCHTEILE

Katalog Nr.	Wendeschneidplatte		Führungsleiste	
	Schraube	Schlüssel	Schraube	Schlüssel
MCTRCH14... - MCTRCH20...	SR14-560/S	T-8F	SR34-508	T-7F
MCTRCH23... - MCTRCH24...	SR14-571/S	T-10/5	SR34-508	T-7F
MCTRCH28...	SR14-506	T-15F	SR34-508	T-7F

Empf. Drehmoment (N·m) für Klemmung: SR34-508=0.9, SR14-560/S=1.2, SR14-571/S=3.2, SR14-506=4.8

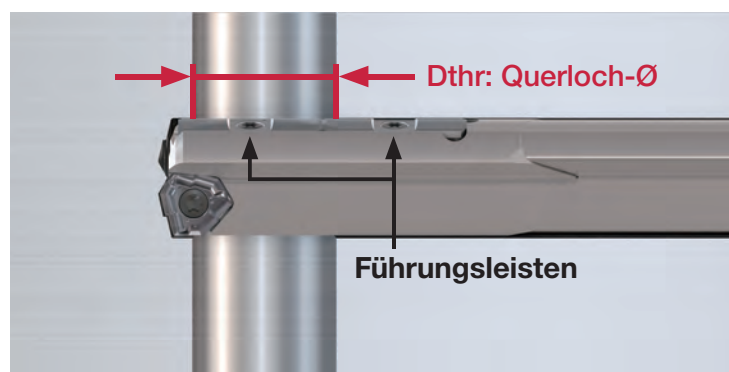

Wendeschneidplatten → [S. 23](#) Führungsleisten → [S. 25](#)

ARTIKEL NR. FÜR SONDERANFERTIGUNGEN

Bei Sonderanfertigungen bitte unten aufgeführten Schlüsselcode zur Erstellung Ihrer Artikel Nr. (Bestellnummer) verwenden.

1	MCTR	2	18.50	XM	3	25	-	4	22
1 Serie		2 Bohrer-Ø. DC (mm)		3 Treiber-Ø. DCONMS (mm)		4 LU/DC			
MCTR	DeepTri-Drill (Für Bearbeitungszentren und Drehmaschinen)	18.50	18.50	25	25				
MCTRCH	DeepTri-Drill (Für Querlochbohrungen auf Bearbeitungszentren und CNC Drehmaschinen)								

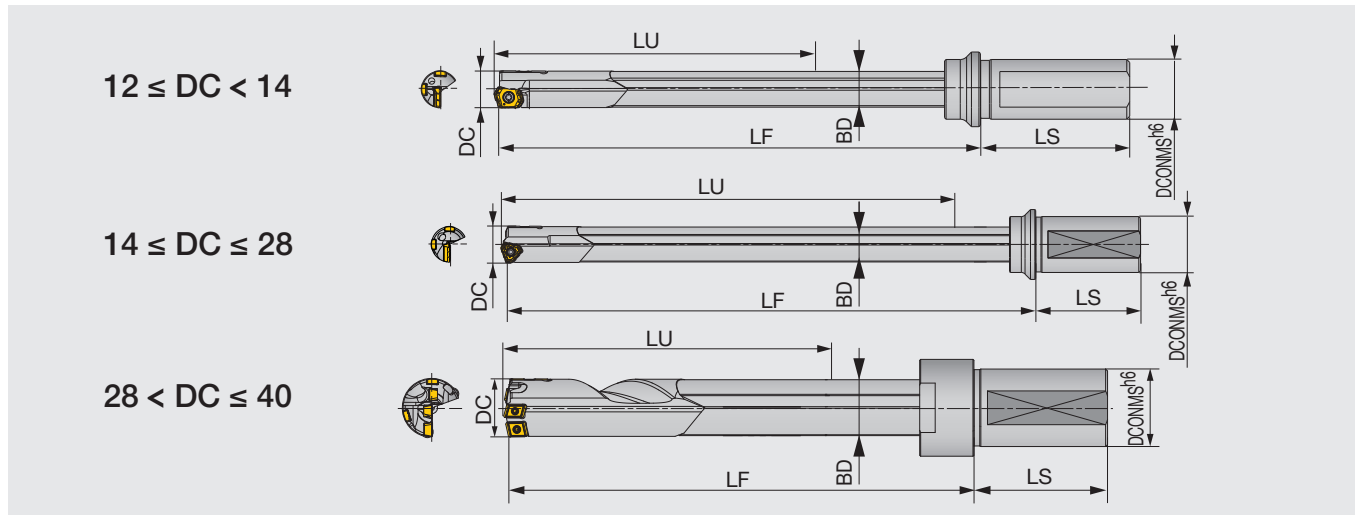

VERFÜGBARE ABMESSUNGEN FÜR SONDERANFERTIGUNGEN

DC	DCONMS	LU	LS	LF	BD	DC	DCONMS	LU	LS	LF	BD
12 - 12.49	20	124.8 - 326.8	50	153 - 225	11.5	24.7 - 25.69	32	211.4 - 653.7	60	260 - 702	24
12.5 - 12.99	20	123.8 - 326.8	50	153 - 226	12	25.7 - 26.69	40	219.7 - 678.7	70	270 - 719	25
13 - 13.49	25	122.8 - 351.8	56	156 - 245	12.5	26.7 - 27.69	40	227.7 - 703.7	70	279 - 745	26
13.5 - 13.99	25	122.8 - 351.8	56	156 - 245	13	27.7 - 28	40	227.7 - 703.7	70	281 - 747	27
14 - 14.49	25	122 - 377	56	156 - 411	13.5	28.01 - 29	40	148.7 - 728.7	69	215 - 795	27
14.5 - 14.99	25	122 - 377	56	157 - 412	14	29.01 - 29.99	40	153.7 - 753.7	69	222 - 822	28
15 - 15.99	25	130 - 402	56	166 - 438	14.5	30 - 31	40	158.7 - 778.7	69	228 - 848	29
16 - 16.79	25	138.2 - 427.2	56	175 - 464	15.5	31.01 - 32	40	163.7 - 803.7	69	235 - 875	30
16.8 - 17.69	25	146.2 - 452.2	56	184 - 490	16.2	32.01 - 33	40	168.7 - 828.7	69	241 - 901	31
17.7 - 18.69	25	154.2 - 478	56	194 - 517	17.2	33.01 - 34	40	173.7 - 853.7	69	248 - 928	32
18.7 - 19.69	25	163 - 503	56	203 - 543	18.2	34.01 - 35	40	178.7 - 878.7	69	253 - 953	32
19.7 - 20.69	32	171 - 528.2	60	213 - 570	19	35.01 - 36	40	183.7 - 903.7	69	261 - 981	34
20.7 - 21.69	32	179.2 - 553.2	60	222 - 596	20	36.01 - 37	40	188.7 - 928.7	69	266 - 1006	34
21.7 - 22.69	32	187.2 - 578.4	60	232 - 623	21	37.01 - 38	40	193.7 - 953.7	69	274 - 1034	36
22.7 - 23.69	32	195.4 - 603.4	60	241 - 649	22	38.01 - 39	40	198.7 - 978.7	69	279 - 1059	36
23.7 - 24.69	32	203.4 - 628.4	60	251 - 676	23	39.01 - 40	40	203.7 - 1003.7	69	287 - 1087	38

TRLG

Tieflochbohrer für Tieflochbohrmaschinen, Werkzeug-Ø 12 - 28 mm

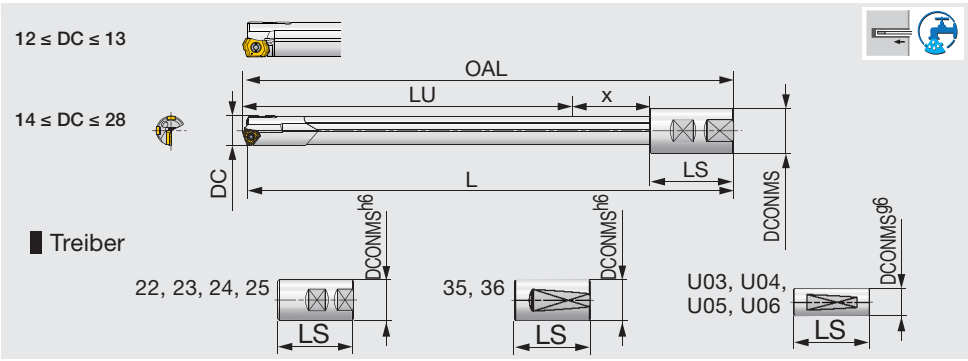

	Katalog Nr.	DC	L	DCONMS	LU	OAL	LS	x	Treiber	Wendeschneidplatte	Führungsleiste
Neu	TRLG12.00X800-U03	12	800	19.05	713.8	801.8	70	18	U03	LOGT06...	GP04-055
Neu	TRLG12.00X800-22	12	800	20	733.8	801.8	50	18	U22	LOGT06...	GP04-055
Neu	TRLG12.00X1000-U03	12	1000	19.05	913.8	1001.8	70	18	U03	LOGT06...	GP04-055
Neu	TRLG12.00X1000-22	12	1000	20	933.8	1001.8	50	18	U22	LOGT06...	GP04-055
Neu	TRLG12.00X1650-U03	12	1650	19.05	1563.8	1651.8	70	18	U03	LOGT06...	GP04-055
Neu	TRLG12.00X1650-22	12	1650	20	1583.8	1651.8	50	18	U22	LOGT06...	GP04-055
Neu	TRLG12.70X1219-U04	12.7	1219	25.4	1131.8	1220.8	70	19	U04	LOGT06..	GP04-055
Neu	TRLG12.70X1524-U04	12.7	1524	25.4	1436.8	1525.8	70	19	U04	LOGT06..	GP04-055
Neu	TRLG13.00X800-U04	13	800	25.4	711.8	801.8	70	20	U04	LOGT06...	GP04-055
Neu	TRLG13.00X800-23	13	800	25	725.8	801.8	56	20	U23	LOGT06...	GP04-055
Neu	TRLG13.00X1000-U04	13	1000	25.4	911.8	1001.8	70	20	U04	LOGT06...	GP04-055
Neu	TRLG13.00X1000-23	13	1000	25	925.8	1001.8	56	20	U23	LOGT06...	GP04-055
Neu	TRLG13.00X1650-U04	13	1650	25.4	1561.8	1651.8	70	20	U04	LOGT06...	GP04-055
Neu	TRLG13.00X1650-23	13	1650	25	1575.8	1651.8	56	20	U23	LOGT06...	GP04-055
Neu	TRLG13.49X1219-U04	13.49	1219	25.4	1130.8	1220.8	70	20	U04	LOGT06..	GP04-055
Neu	TRLG13.49X1527-U04	13.49	1527	25.4	1438.8	1528.8	70	20	U04	LOGT06..	GP04-055
	TRLG14.00X800-23	14	800	25	725	802	56	21	23	TOHT07...	GP05-060
	TRLG14.00X800-U04	14	800	25.4	711	802	70	21	U04	TOHT07...	GP05-060
	TRLG14.00X1000-23	14	1000	25	925	1002	56	21	23	TOHT07...	GP05-060
	TRLG14.00X1000-U04	14	1000	25.4	911	1002	70	21	U04	TOHT07...	GP05-060
	TRLG14.00X1650-23	14	1650	25	1575	1652	56	21	23	TOHT07...	GP05-060
	TRLG14.00X1650-U04	14	1650	25.4	1561	1652	70	21	U04	TOHT07...	GP05-060
	TRLG14.50X800-23	14.5	800	25	724	802	56	22	23	TOHT07...	GP05-060
	TRLG14.50X800-U04	14.5	800	25.4	710	802	70	22	U04	TOHT07...	GP05-060
	TRLG14.50X1000-23	14.5	1000	25	924	1002	56	22	23	TOHT07...	GP05-060
	TRLG14.50X1000-U04	14.5	1000	25.4	910	1002	70	22	U04	TOHT07...	GP05-060
	TRLG14.50X1650-23	14.5	1650	25	1574	1652	56	22	23	TOHT07...	GP05-060
	TRLG14.50X1650-U04	14.5	1650	25.4	1560	1652	70	22	U04	TOHT07...	GP05-060
	TRLG15.00X800-23	15	800	25	723	802	56	23	23	TOHT07...	GP05-060
	TRLG15.00X800-U04	15	800	25.4	709	802	70	23	U04	TOHT07...	GP05-060
	TRLG15.00X1000-23	15	1000	25	923	1002	56	23	23	TOHT07...	GP05-060
	TRLG15.00X1000-U04	15	1000	25.4	909	1002	70	23	U04	TOHT07...	GP05-060
	TRLG15.00X1650-23	15	1650	25	1573	1652	56	23	23	TOHT07...	GP05-060
	TRLG15.00X1650-U04	15	1650	25.4	1559	1652	70	23	U04	TOHT07...	GP05-060
	TRLG16.00X800-23A	16	800	25	722.2	802.2	56	24	23	TOHT08...	GP05-075
	TRLG16.00X800-U04A	16	800	25.4	708.2	802.2	70	24	U04	TOHT08...	GP05-075
	TRLG16.00X1000-23A	16	1000	25	922.2	1002.2	56	24	23	TOHT08...	GP05-075
	TRLG16.00X1000-U04A	16	1000	25.4	908.2	1002.2	70	24	U04	TOHT08...	GP05-075
	TRLG16.00X1500-23A	16	1500	25	1422.2	1502.2	56	24	23	TOHT08...	GP05-075
	TRLG16.00X1500-U04A	16	1500	25.4	1408.2	1502.2	70	24	U04	TOHT08...	GP05-075

Katalog Nr.	DC	L	DCONMS	LU	OAL	LS	x	Treiber	Wendeschneidplatte	Führungsleiste
TRLG17.00X800-23A	17	800	25	721.2	802.2	56	25	23	TOHT08...	GP05-075
TRLG17.00X800-U04A	17	800	25.4	707.2	802.2	70	25	U04	TOHT08...	GP05-075
TRLG17.00X1000-23A	17	1000	25	921.2	1002.2	56	25	23	TOHT08...	GP05-075
TRLG17.00X1000-U04A	17	1000	25.4	907.2	1002.2	70	25	U04	TOHT08...	GP05-075
TRLG18.00X800-23A	18	800	25	719.2	802.2	56	27	23	TOHT08...	GP05-075
TRLG18.00X800-U04A	18	800	25.4	705.2	802.2	70	27	U04	TOHT08...	GP05-075
TRLG18.00X1000-23A	18	1000	25	919.2	1002.2	56	27	23	TOHT08...	GP05-075
TRLG18.00X1000-U04A	18	1000	25.4	905.2	1002.2	70	27	U04	TOHT08...	GP05-075
TRLG18.00X1500-23A	18	1500	25	1419.2	1502.2	56	27	23	TOHT08...	GP05-075
TRLG18.00X1500-U04A	18	1500	25.4	1405.2	1502.2	70	27	U04	TOHT08...	GP05-075
TRLG18.50X1500-23	18.5	1500	25	1420	1503	56	27	23	TOHT09...	GP06-085
TRLG18.50X1500-U04	18.5	1500	25.4	1406	1503	70	27	U04	TOHT09...	GP06-085
TRLG19.00X800-23	19	800	25	719	803	56	28	23	TOHT09...	GP06-085
TRLG19.00X800-U04	19	800	25.4	705	803	70	28	U04	TOHT09...	GP06-085
TRLG19.00X1000-23	19	1000	25	919	1003	56	28	23	TOHT09...	GP06-085
TRLG19.00X1000-U04	19	1000	25.4	905	1003	70	28	U04	TOHT09...	GP06-085
TRLG20.00X800-24	20	800	32	713	803	60	30	24	TOHT09...	GP06-085
TRLG20.00X800-U05	20	800	31.75	703	803	70	30	U05	TOHT09...	GP06-085
TRLG20.00X1000-24	20	1000	32	913	1003	60	30	24	TOHT09...	GP06-085
TRLG20.00X1000-U05	20	1000	31.75	903	1003	70	30	U05	TOHT09...	GP06-085
TRLG21.00X1000-24	21	1000	32	912.2	1003.2	60	31	24	TOHT10...	GP06-085
TRLG21.00X1000-U05	21	1000	31.75	902.2	1003.2	70	31	U05	TOHT10...	GP06-085
TRLG22.00X1000-24	22	1000	32	910.4	1003.4	60	33	24	TOHT11...	GP06-100
TRLG22.00X1000-U05	22	1000	31.75	900.4	1003.4	70	33	U05	TOHT11...	GP06-100
TRLG22.00X1500-24	22	1500	32	1410.4	1503.4	60	33	24	TOHT11...	GP06-100
TRLG22.00X1500-U05	22	1500	31.75	1400.4	1503.4	70	33	U05	TOHT11...	GP06-100
TRLG23.00X1000-24	23	1000	32	909.4	1003.4	60	34	24	TOHT11...	GP06-100
TRLG23.00X1000-U05	23	1000	31.75	899.4	1003.4	70	34	U05	TOHT11...	GP06-100
TRLG23.00X1500-24	23	1500	32	1409.4	1503.4	60	34	24	TOHT11...	GP06-100
TRLG23.00X1500-U05	23	1500	31.75	1399.4	1503.4	70	34	U05	TOHT11...	GP06-100
TRLG24.00X1000-24	24	1000	32	907.4	1003.4	60	36	24	TOHT11...	GP06-100
TRLG24.00X1000-U05	24	1000	31.75	897.4	1003.4	70	36	U05	TOHT11...	GP06-100
TRLG24.00X1500-24	24	1500	32	1407.4	1503.4	60	36	24	TOHT11...	GP06-100
TRLG24.00X1500-U05	24	1500	31.75	1397.4	1503.4	70	36	U05	TOHT11...	GP06-100
TRLG25.00X1000-24	25	1000	32	906.4	1003.4	60	37	24	TOHT11...	GP06-100
TRLG25.00X1000-U05	25	1000	31.75	896.4	1003.4	70	37	U05	TOHT11...	GP06-100
TRLG26.00X1000-25	26	1000	40	894.7	1003.7	70	39	25	TOHT12...	GP06
TRLG26.00X1000-U06	26	1000	38.1	894.7	1003.7	70	39	U06	TOHT12...	GP06
TRLG27.00X1000-25	27	1000	40	893.7	1003.7	70	40	25	TOHT12...	GP06
TRLG27.00X1000-U06	27	1000	38.1	893.7	1003.7	70	40	U06	TOHT12...	GP06
TRLG28.00X1000-25	28	1000	40	891.7	1003.7	70	42	25	TOHT12...	GP06
TRLG28.00X1000-U06	28	1000	38.1	891.7	1003.7	70	42	U06	TOHT12...	GP06

DC	Werkzeug-Ø Toleranz	Bohrungs-Ø Toleranz
12 - 28	0 / - 0.07	+ 0.05 / - 0.1

AUSTAUSCHTEILE

Katalog Nr.	Wendeschneidplatte		Führungsleiste	
	Schraube	Schlüssel	Schraube	Schlüssel
TRLG12... - TRLG13...	SR10503833L040	T-7F	CSPB-2L043	IP-6F
TRLG14... - TRLG20...	SR14-560/S	T-8F	SR34-508	T-7F
TRLG21...	SR34-506	T-9F	SR34-508	T-7F
TRLG22... - TRLG25...	SR14-571/S	T-10/5	SR34-508	T-7F
TRLG26... - TRLG28...	SR14-506	T-15F	SR34-508	T-7F

Empf. Drehmoment (N·m) für Klemmung: CSPB-2L043=0.7, SR34-508=0.9, SR34-506=0.9, SR14-560/S=1.2, SR10503833L040=1.3, SR14-571/S=3.2, SR14-506=4.8

Wendeschneidplatten → **S. 23** Führungsleisten → **S. 25**

TRLGCH

Tieflochbohrer für Querbohrungen auf Tieflochbohrmaschinen, Werkzeug-Ø 14.68 mm - 24 mm

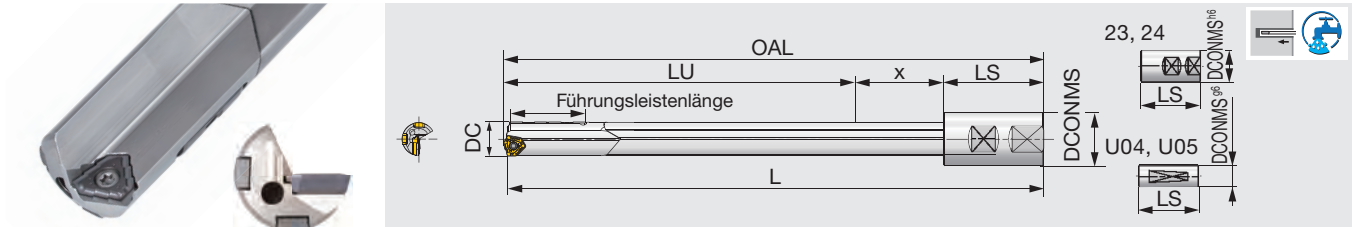

Katalog Nr.	DC	L	DCONMS	LU	OAL	LS	X	Treiber	Wendeschneidplatten	Führungsleisten	Führungsleistenlänge
TRLGCH14.68X1830-U05	14.68	1830	31.75	1740	1832	70	22	U05	TOHT07...	GP05 - 060	32
TRLGCH15.00X1650-U04	15	1650	25.4	1559	1652	70	23	U04	TOHT07...	GP05 - 060	32
TRLGCH15.00X1650-23	15	1650	25	1573	1652	56	23	23	TOHT07...	GP05 - 060	32
TRLGCH15.06X1830-U05	15.06	1830	31.75	1739	1832	70	23	U05	TOHT07...	GP05 - 060	32
TRLGCH18.00X1650-U04A	18	1650	25.4	1555.2	1652.2	70	27	U04	TOHT08...	GP05 - 075	32
TRLGCH18.00X1650-23A	18	1650	25	1569.2	1652.2	56	27	23	TOHT08...	GP05 - 075	40
TRLGCH18.24X1830-U05	18.24	1830	31.75	1736	1833	70	27	U05	TOHT09...	GP06 - 085	40
TRLGCH18.64X1830-U05	18.64	1830	31.75	1736	1833	70	27	U05	TOHT09...	GP06 - 085	40
TRLGCH23.00X1650-U05	23	1650	31.75	1549.4	1653.4	70	34	U05	TOHT11...	GP06 - 100	40
TRLGCH23.00X1650-24	23	1650	32	1559.4	1653.4	60	34	24	TOHT11...	GP06 - 100	40
TRLGCH23.42X1830-U05	23.42	1830	31.75	1729.4	1833.4	70	34	U05	TOHT11...	GP06 - 100	40
TRLGCH23.80X1830-U05	23.8	1830	31.75	1727.4	1833.4	70	36	U05	TOHT11...	GP06 - 100	40
TRLGCH24.00X1650-U05	24	1650	31.75	1547.4	1653.4	70	36	U05	TOHT11...	GP06 - 100	40
TRLGCH24.00X1650-24	24	1650	32	1557.4	1653.4	60	36	24	TOHT11...	GP06 - 100	40

DC	Werkzeug-Ø Toleranz	Bohrungs-Ø Toleranz
14.68 - 24	0 / - 0.09	+ 0.05 / - 0.12

AUSTAUSCHTEILE

Katalog Nr.	Wendeschneidplatte		Führungsleiste	
	Schraube	Schlüssel	Schraube	Schlüssel
TRLGCH14... - TRLGCH18...	SR14-560/S	T-8F	SR34-508	T-7F
TRLGCH23... - TRLGCH24...	SR14-571/S	T-10/5	SR34-508	T-7F

Empf. Drehmoment (N·m) für Klemmung: SR34-508=0.9, R14-560/S=1.2, SR14-571/S=3.2

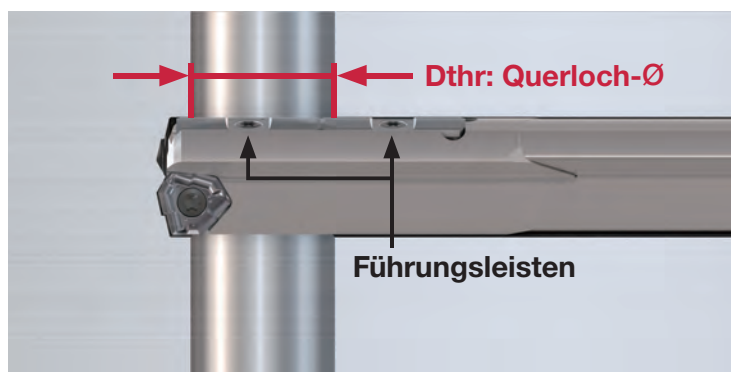

Wendeschneidplatten → S. 23 Führungsleisten → S. 25

TRLG

Tieflochbohrer für Tieflochbohrmaschinen, Werkzeug-Ø 29.36, 30 mm

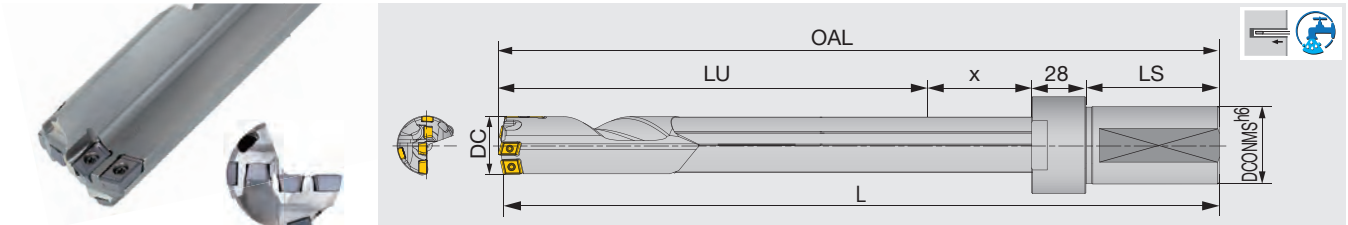

Katalog Nr.	DC	L	DCONMS	LU	OAL	LS	x	Treiber	Wendeschneidplatten	Führungsleisten
TRLG29.36X1828-FU31.75	29.36	1828	31.75	1689.6	1830.6	69	44	FU31.75	FBM06**-C, FBM05**-I, FBH06**-P	GP06
TRLG30.00X1000-FM40	30	1000	40	860.9	1002.9	69	45	FM40	FBM06**-C, FBM06**-I, FBH07**-P	GP06
TRLG30.00X1650-FM40	30	1650	40	1510.9	1652.9	69	45	FM40	FBM06**-C, FBM06**-I, FBH07**-P	GP06
TRLG30.00X1650-FU38.1	30	1650	38.1	1510.9	1652.9	69	45	FU38.1	FBM06**-C, FBM06**-I, FBH07**-P	GP06

DC	Werkzeug-Ø Toleranz	Bohrungs-Ø Toleranz
29.36, 30	0 / - 0.07	+ 0.05 / - 0.1

Max. DC = 40: Verfügbare Sonderanfertigungen

AUSTAUSCHTEILE

Katalog Nr.	Wendeschneidplatte						Führungsleiste	
	Zentrum		Mitte		Außen		Schraube	Schlüssel
	Schraube	Schlüssel	Schraube	Schlüssel	Schraube	Schlüssel		
TRLG29.36...	CSTB-2.5	T-8F	CSTB-2.2	T-7F	CSTB-2.2	T-7 F	SR34-508	T-7F
TRLG30...	CSTB-2.5	T-8F	CSTB-2.5	T-8F	CSTB-2.5	T-8F	SR34-508	T-7F

Empf. Drehmoment (N·m) für Klemmung: R34-508=0.9, CSTB-2.5=1.3

Hinweis: Bohrer im Bereich der Spanablaufzone brüniert. Die fertige Oberfläche kann uneben erscheinen. Dies hat keine Auswirkungen auf die Bohrerleistung.

Wendeschneidplatten → [S. 24](#) Führungsleisten → [S. 25](#)

ARTIKEL NR. FÜR SONDERANFERTIGUNGEN

Bei Spezialanfertigungen bitte unten aufgeführten Schlüsselcode zur Erstellung Ihrer Artikel Nr. (Bestellnummer) verwenden.

1 **TRLG** **2** **18.50** **X** **3** **900** **-** **4** **23**

1 Serie		2 Bohrer-Ø Dc (mm)		3 Gesamtlänge L (mm)		4 Treiber	
TRLG	DeepTri-Drill (Für Tieflochbohrmaschinen)	18.50	18.50	900	900	23	23
TRLGCH	DeepTri-Drill (Für Querbohrungen auf Tieflochbohrmaschinen)						

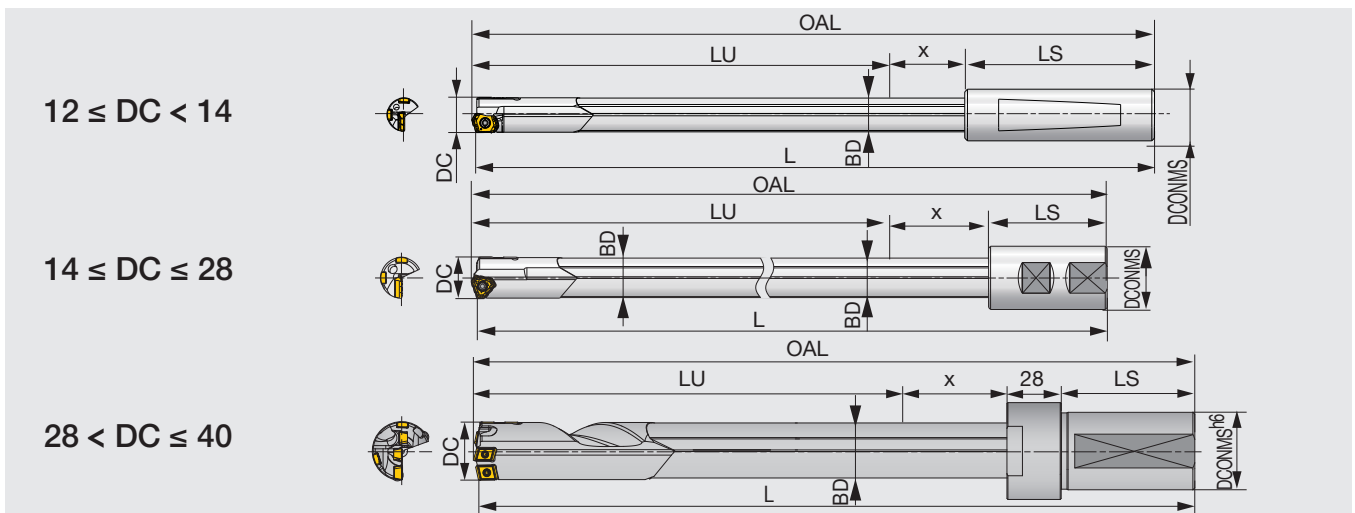

VERFÜGBARE BEREICHE FÜR SONDERANFERTIGUNGEN

DC	L	x	BD	DC	L	x	BD
12 - 12.49	400 - 2400	18	11.5	24.7 - 25.69	400 - 2400	37	24
12.5 - 12.99	400 - 2400	19	12	25.7 - 26.69	400 - 2400	39	25
13 - 13.49	400 - 2400	20	12.5	26.7 - 27.69	400 - 2400	40	26
13.5 - 13.99	400 - 2400	20	13	27.7 - 28	400 - 2400	42	27
14 - 14.49	400 - 2400	21	13.5	28.01 - 29	400 - 2400	42	27
14.5 - 14.99	400 - 2400	22	14	29.01 - 29.99	400 - 2400	44	28
15 - 15.99	400 - 2400	23	14.5	30 - 31	400 - 2400	45	29
16 - 16.79	400 - 2400	24	15.5	31.01 - 32	400 - 2400	47	30
16.8 - 17.69	400 - 2400	25	16.2	32.01 - 33	400 - 2400	48	31
17.7 - 18.69	400 - 2400	27	17.2	33.01 - 34	400 - 2400	50	32
18.7 - 19.69	400 - 2400	28	18.2	34.01 - 35	400 - 2400	50	32
19.7 - 20.69	400 - 2400	30	19	35.01 - 36	400 - 2400	53	34
20.7 - 21.69	400 - 2400	31	20	36.01 - 37	400 - 2400	53	34
21.7 - 22.69	400 - 2400	33	21	37.01 - 38	400 - 2400	56	36
22.7 - 23.69	400 - 2400	34	22	38.01 - 39	400 - 2400	56	36
23.7 - 24.69	400 - 2400	36	23	39.01 - 40	400 - 2400	59	38

Bitte geben Sie die Treiber Form entsprechend Ihrer Anfrage an.

WENDESCHNEIDPLATTEN

LOGT-NDJ

Neu

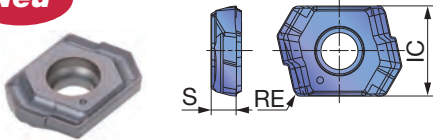

Katalog Nr.	DCN-DCX	AH725	IC	S	RE
LOGT060204R-NDJ	12 - 13.99	●	7.08	2	0.4

TOHT-NDL (07..., 08...)

Neu

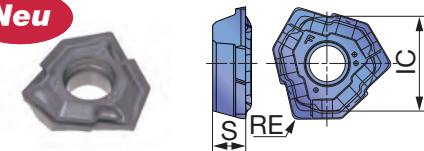

TOHT-NDL (09... - 12...)

Neu

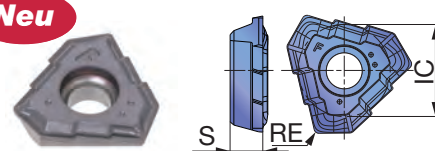

Katalog Nr.	DCN-DCX	AH725	IC	S	RE
TOHT070304R-NDL	14 - 15.99	●	7.69	2.3	0.4
TOHT080305R-NDL	16 - 18	●	8.55	2.8	0.5
TOHT090305R-NDL	18.01 - 20	●	8.32	3	0.5
TOHT100305R-NDL	20.01 - 21.99	●	9.23	3.3	0.5
TOHT110405R-NDL	22 - 25	●	10.4	3.8	0.5
TOHT120405R-NDL	25.01 - 28	●	11.59	4.3	0.5

TOHT-NDJ (07..., 08...)

TOHT-NDJ (09... - 12...)

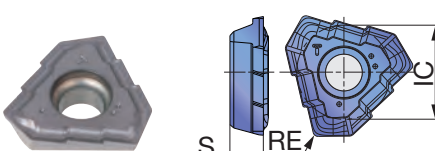
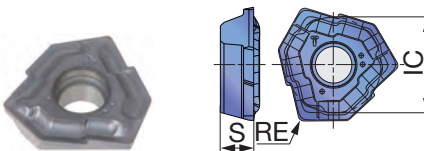

Katalog Nr.	DCN-DCX	AH725	IC	S	RE
TOHT070304R-NDJ	14 - 15.99	●	7.69	2.3	0.4
TOHT080305R-NDJ	16 - 18	●	8.55	2.8	0.5
TOHT090305R-NDJ	18.01 - 20	●	8.32	3	0.5
TOHT100305R-NDJ	20.01 - 21.99	●	9.23	3.3	0.5
TOHT110405R-NDJ	22 - 25	●	10.4	3.8	0.5
TOHT120405R-NDJ	25.01 - 28	●	11.59	4.3	0.5

■ Kennzeichnung NDL- und NDJ-Geometrien

Spanformstufe	NDL	NDJ
Schneidkantenstabilität	stark	sehr stark
Kennzeichnung auf der Wendschneidplatte		

■ Empfohlene Vorschübe

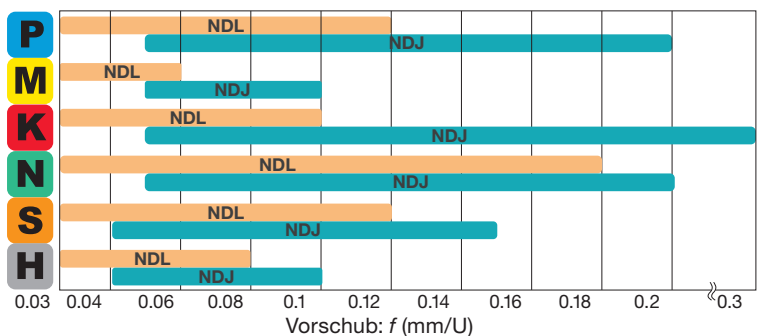

FBM-C (Zentrum)

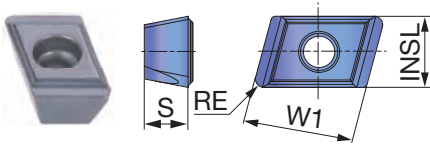

Katalog Nr.	DCN-DCX	UC2220	UC3120	INSL	W1	S	RE
FBM06504LG-C	28.01 - 35	●		6.5	10	4	0.8
FBM08004LG-C	35.01 - 40	●		8	10	4	0.8

FBM-I (Mitte)

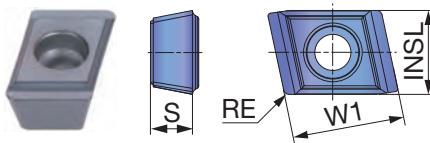

Katalog Nr.	DCN-DCX	UC2220	UC3120	INSL	W1	S	RE
FBM05503RG-I	28.01 - 29.99	●		5.5	8	3	0.4
FBM06504RG-I	30 - 40	●		6.5	10	4	0.4

FBH-P (Außen)

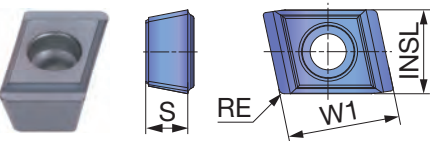

Katalog Nr.	DCN-DCX	UC2220	UC3120	INSL	W1	S	RE
FBH06003RG-P	28.01 - 29.99	●	●	6	8	3	0.4
FBH07504RG-P	30 - 38	●	●	7.5	10	4	0.4
FBH09004RG-P	38.01 - 40	●	●	9	10	4	0.4

● Lagerstandard
VE = 10 Stk.

HARTMETALL FÜHRUNGSLEISTEN

GP04,05, 06, 07, 08

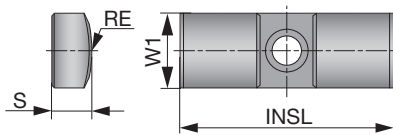

Katalog Nr.	DC	F1122	F2122	W1	INSL	S	RE
Neu GP04-055	12 - 13.99	●	●	4	16	2	5.5
GP05-060	14 - 15.99	●	●	5	18	2.5	6
GP05-075	16 - 18	●	●	5	18	2.5	7.5
GP06-085	18.01 - 21	●	●	6	20	3	8.5
GP06-100	21.01 - 25	●	●	6	20	3	10
GP06	25.01 - 33	●	●	6	20	3	12
GP07	33.01-38	●	●	7	20	3.5	12
GP08	38.01-40	●	●	8	25	4.5	15.5

● Lagerstandard
VE = 5 Stk.

Austausch von Führungsleisten

Führungsleisten sind Verschleißteile, vergleichbar mit Wendeschneidplatten

- Jede Führungsleiste verfügt über 2 verwendbare Seiten.
- Wenn die Breite des Verschleißes an der ersten Seite 70% der Breite der Führungsleiste erreicht, Führungsleiste umdrehen und zweite Seite verwenden.
- Führungsleiste ersetzen, wenn die zweite Seite den gleichen Vergleich anzeigt wie die erste Seite.

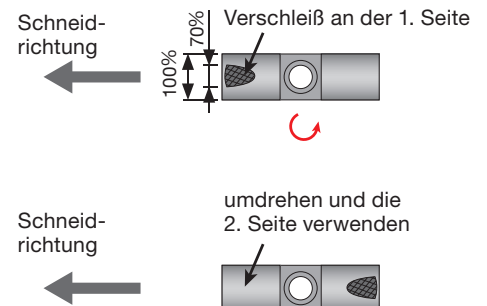
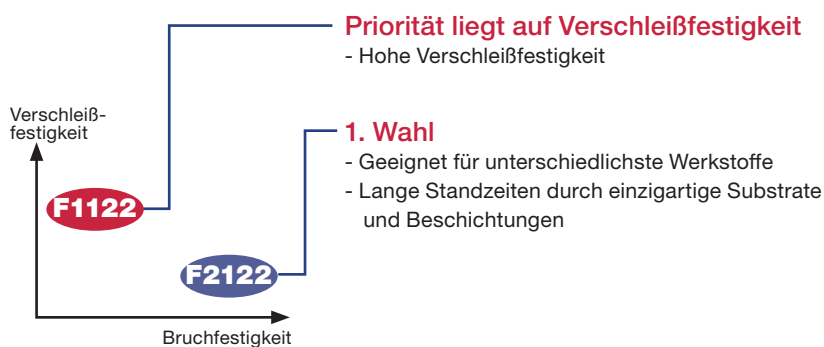

Neu

SHIMS (Hinterlagen)

Für die Feineinstellung von Lochdurchmessern

SHIMSET-GP04

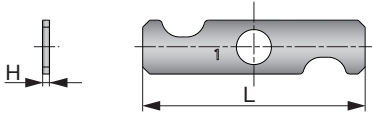

SHIMSET-GP05

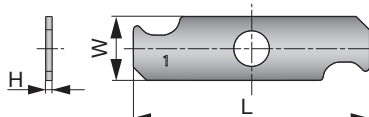

SHIMSET-GP06

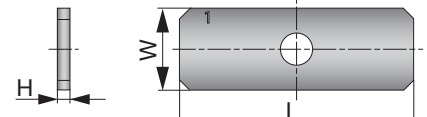

Katalog Nr.	DC	W	L	H
SHIMSET-GP04	12 - 13.99	4	16	2
SHIMSET-GP05	14 - 18	5	18	2.5
SHIMSET-GP06	18.01 - 33	5	18	2.5

- Ein Shim-Set beinhaltet 5 Shims in der Dicke von 0.01 mm, 0.02 mm, 0.03 mm, 0.04 mm, und 0.05 mm. D.h. 1 Stück pro Dicke.
 - Shims zur Durchmesserkorrektur werden nur Satzweise verkauft und sind nicht einzeln erhältlich.

Shim-Kombinationen zur Durchmesserkorrektur

Durchmesserkorrektur	Shimdicke - Geradheit	Shimdicke - Führungsleiste Durchmesser	Erforderliche Anzahl Shim-Sets
+0.01	0.01	-	1
+0.02	0.02	0.01	1
+0.03	0.03	0.01 + 0.02	1
+0.04	0.04	0.01 + 0.03	1
+0.05	0.05	0.02 + 0.03	1
+0.06	0.01 + 0.05	0.02 + 0.04	1
+0.07	0.02 + 0.05	0.03 + 0.04	1
+0.08	0.03 + 0.05	0.04 + 0.04	2
+0.09	0.04 + 0.05	0.04 + 0.05	2
+0.1	0.05 + 0.05	0.04 + 0.04 + 0.02	2

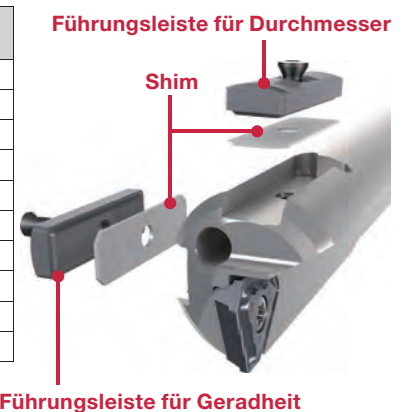

Einbau der Shims (Hinterlagen)

1. Messen des Bohrer-Ø

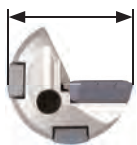

3. Entfernen der Führungsleisten



2. Auswahl der Größe der Shim zur Korrektur

Hinweis: Berücksichtigen Sie, dass sich der Lochdurchmesser beim Bohren vergrößern kann (für +0.02 bis +0.03 mm).



4. Legen Sie die Shims unter beide Führungsleisten

5. Messen, ob der erforderliche Durchmesser erreicht wird



6. Testlochbohrung, um sicherzustellen, dass die erforderliche Lochgröße erreicht wird

Hinweis: Für eine höhere Bohrgenauigkeit, nach Schritt 1 ein Loch bohren, um den Größenunterschied zwischen dem gemessenen Bohrdurchmesser und dem tatsächlich gebohrten Lochdurchmesser zu bestätigen.

STANDARD SCHNITTDATEN

ISO	Werkstoffe	Auswahl	Span- form- stufe	Schnitt- geschwin- digkeit V _c (m/min)	Vorschub: f (mm/U)			
					ø12 - ø13.99	ø14 - ø18	ø18.01 - ø28	ø28.01 - ø40
P	Stahl mit niedrigem Kohlenstoffgehalt (C < 0.3) St42-1, St52-3, C25, etc.	Geringer Vorschub	NDL	50 - 100	-	0.03 - 0.1	0.03 - 0.1	-
		1. Wahl	NDJ/G	80 - 140	0.05 - 0.1	0.05 - 0.1	0.05 - 0.1	0.1 - 0.2
	Kohlenstoffstahl (C > 0.3) C45, C55, etc.	Geringer Vorschub	NDL	50 - 100	-	0.03 - 0.1	0.03 - 0.12	-
		1. Wahl	NDJ/G	80 - 140	0.05 - 0.16	0.05 - 0.16	0.05 - 0.2	0.1 - 0.2
	Niedrig legierter Stahl (C < 0.3) SCM415, etc.	Geringer Vorschub	NDL	50 - 100	-	0.03 - 0.1	0.03 - 0.1	-
		1. Wahl	NDJ/G	80 - 140	0.05 - 0.1	0.05 - 0.1	0.05 - 0.1	0.1 - 0.2
Legierter Stahl (C > 0.3) 42CrMo4, 20Cr4, etc.	Geringer Vorschub	NDL	50 - 100	-	0.03 - 0.1	0.03 - 0.12	-	
	1. Wahl	NDJ/G	80 - 120	0.05 - 0.16	0.05 - 0.16	0.05 - 0.2	0.1 - 0.2	
M	Rostfreier Stahl (Austenitisch) X5CrNi18-9, X5CrNiMo17-12-3, etc.	Geringer Vorschub	NDL	50 - 100	-	0.03 - 0.06	0.03 - 0.06	-
		1. Wahl	NDJ/G	60 - 100	0.05 - 0.1	0.05 - 0.1	0.05 - 0.1	0.1 - 0.15
	Rostfreier Stahl (Martensitisch, Ferritisch) X6Cr17, X12CrS13, etc.	Geringer Vorschub	NDL	50 - 100	-	0.03 - 0.06	0.03 - 0.06	-
		1. Wahl	NDJ/G	60 - 100	0.05 - 0.1	0.05 - 0.1	0.05 - 0.1	0.1 - 0.15
	Rostfreier Stahl (Duplex) X5CrNiCuNb16-4, etc.	Geringer Vorschub	NDL	50 - 100	-	0.03 - 0.06	0.03 - 0.06	-
		1. Wahl	NDJ/G	60 - 100	0.05 - 0.1	0.05 - 0.1	0.05 - 0.1	0.1 - 0.15
K	Grauguss GG25, etc.	Geringer Vorschub	NDL	50 - 100	-	0.03 - 0.15	0.05 - 0.18	-
		1. Wahl	NDJ/G	80 - 140	0.05 - 0.25	0.05 - 0.25	0.05 - 0.3	0.1 - 0.3
	Kugelgraphitguss GGG70, etc.	Geringer Vorschub	NDL	50 - 100	-	0.03 - 0.15	0.05 - 0.18	-
		1. Wahl	NDJ/G	80 - 140	0.05 - 0.25	0.05 - 0.25	0.05 - 0.3	0.1 - 0.3
N	Aluminiumlegierungen	Geringer Vorschub	NDL	80 - 160	-	0.03 - 0.15	0.03 - 0.15	-
		1. Wahl	NDJ/G	100 - 200	0.05 - 0.2	0.05 - 0.2	0.05 - 0.2	0.1 - 0.25
S	Hitzebeständige Legierungen Inconel718, etc.	Geringer Vorschub	NDL	20 - 50	-	0.03 - 0.06	0.03 - 0.08	-
		1. Wahl	NDJ/G	20 - 50	0.04 - 0.08	0.04 - 0.08	0.04 - 0.1	0.06 - 0.13
	Titanlegierungen Ti-6Al-4V, etc.	Geringer Vorschub	NDL	30 - 60	-	0.03 - 0.1	0.03 - 0.12	-
		1. Wahl	NDJ/G	30 - 60	0.05 - 0.13	0.05 - 0.13	0.05 - 0.15	0.1 - 0.18
H	Gehärteter Stahl ≥ 40HRC	Geringer Vorschub	NDL	40 - 100	-	0.03 - 0.08	0.03 - 0.08	-
		1. Wahl	NDJ/G	50 - 100	0.04 - 0.08	0.04 - 0.08	0.04 - 0.1	0.06 - 0.13

ANWENDUNGSGEBIETE

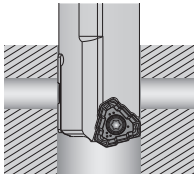
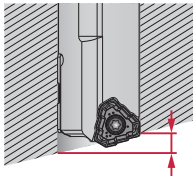
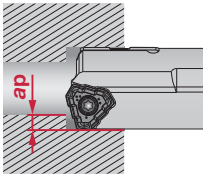
Vorschub f (mm/U)	0.03 - 0.05	0.03 - 0.05	0.1 - 0.3
Anwendung	<p>OK Querbohrungen</p> 	<p>OK Schiefe Ebene</p>  <p>16 mm oder weniger (für Standardbohrer)</p>	<p>OK Aufbohren</p> 

Hinweis 1:

Achten Sie auf die Länge der Führungsleiste beim Bohren von Werkstücken mit Querbohrungen oder Werkstücken mit schrägem Austritt.

Hinweis 2:

Eine Pilotbohrung ist auch beim Aufbohren erforderlich. Ein Aufmaß von $a_p \geq 1$ mm wird empfohlen.

PROFIL IM BOHRGRUND

DC	Wendeschneidplatten	Max. Differenz PL
Neu 12 - 13.99	LOGT06	1.8
14 - 15.99	TOHT07	2
16 - 18	TOHT08	2.2
18.01 - 20	TOHT09	3
20.01 - 21.99	TOHT10	3.2
22 - 25	TOHT11	3.4
25.01 - 28	TOHT12	3.7

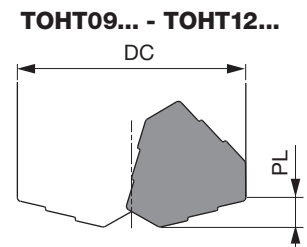
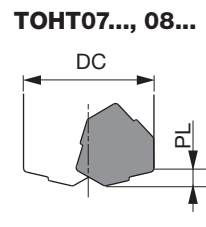
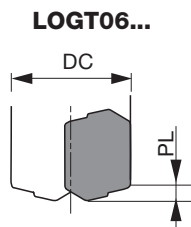

DC	Wendeschneidplatte			Max. Differenz PL
	Zentrum	Mitte	Außen	
28.01 - 29	FBM06504LG-C	FBM05503RG-I	FBH06003RG-P	2.6
29.01 - 29.99	FBM06504LG-C	FBM05503RG-I	FBH06003RG-P	2.6
30 - 31	FBM06504LG-C	FBM06504RG-I	FBH07504RG-P	2.9
31.01 - 32	FBM06504LG-C	FBM06504RG-I	FBH07504RG-P	3
32.01 - 33	FBM06504LG-C	FBM06504RG-I	FBH07504RG-P	3.1
33.01 - 34	FBM06504LG-C	FBM06504RG-I	FBH07504RG-P	3
34.01 - 35	FBM06504LG-C	FBM06504RG-I	FBH07504RG-P	3.1
35.01 - 36	FBM08004LG-C	FBM06504RG-I	FBH07504RG-P	3.1
36.01 - 37	FBM08004LG-C	FBM06504RG-I	FBH07504RG-P	3
37.01 - 38	FBM08004LG-C	FBM06504RG-I	FBH07504RG-P	3.1
38.01 - 39	FBM08004LG-C	FBM06504RG-I	FBH09004RG-P	3.4
39.01 - 40	FBM08004LG-C	FBM06504RG-I	FBH09004RG-P	3.3

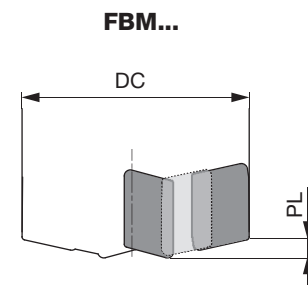

ERFORDERLICHE SPINDELLEISTUNG UND KÜHLMITTELDRUCK

Nutzleistung

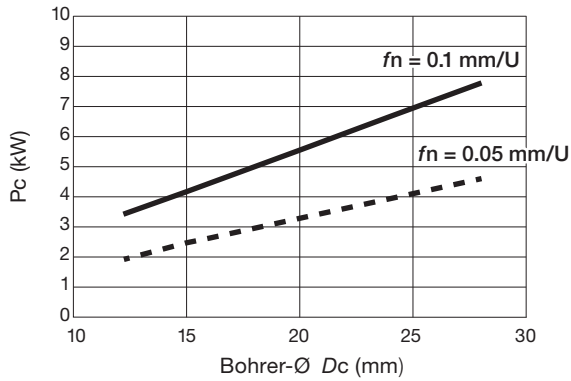

Drehmoment

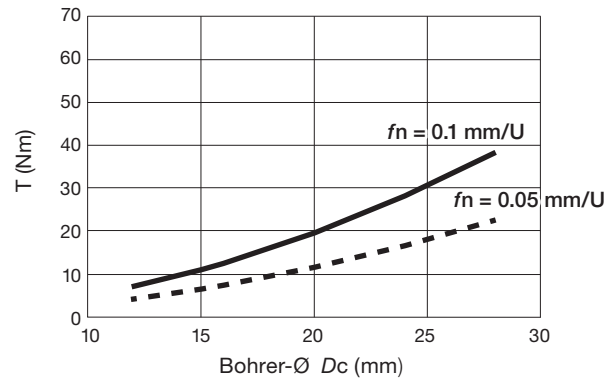

Nutzleistung

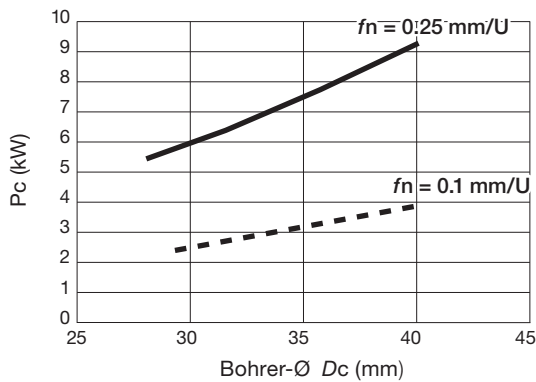

Drehmoment

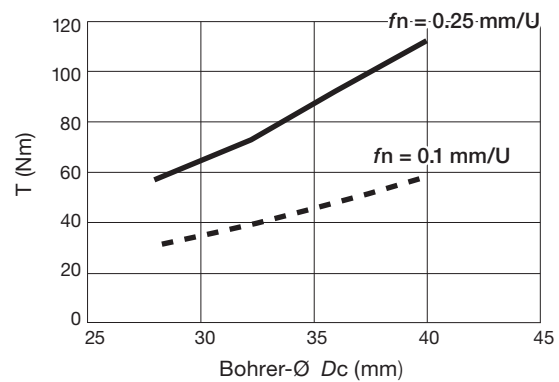

Kühlmitteldruck

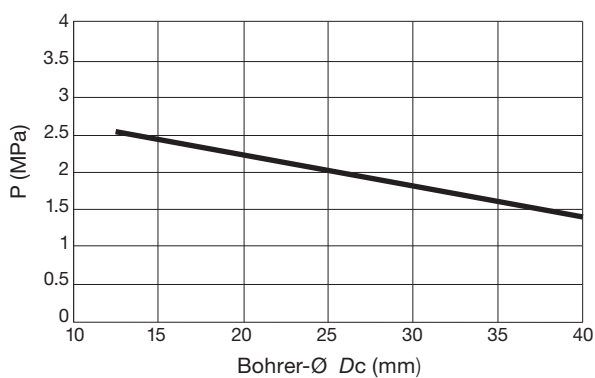

Kühlmitteldurchfluss

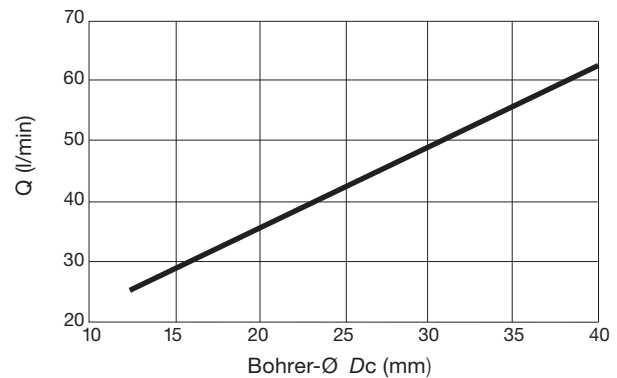

BOHRVORGANG AUF BEARBEITUNGSZENTREN UND DREHMASCHINEN

Für maximale Leistung wird folgender Ablauf empfohlen:

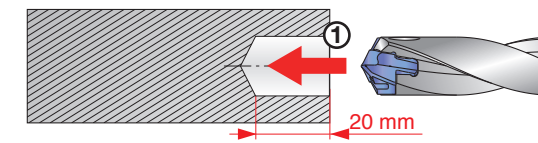

① Pilotbohrung

Bohrungs-Ø Toleranz: +0.01 - +0.1 mm
Bohrungstiefe: H = 20 mm

Verwendung von DrillMeister oder DrillForce-Meister für die Pilotbohrung. Bohrer 3xD oder kleiner verwenden.

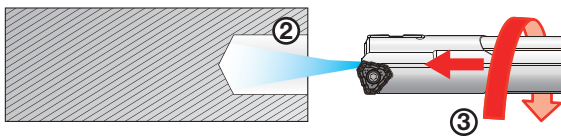

② Zufuhr Kühlmittelflüssigkeit

③ Langsam DeepTri-Drill in die Pilotbohrung einführen

Drehzahl: $n = 50 - 100 \text{ min}^{-1}$
Vorschubgeschwindigkeit: $V_f = 100 - 300 \text{ mm/min}$

WARNUNG: Den Bohrer außerhalb der Bohrung nicht auf Bearbeitungsgeschwindigkeit rotieren lassen

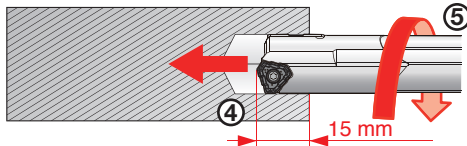

④ Bei 10 mm Tiefe, Bohrer stoppen

⑤ Bohrer auf Bearbeitungsgeschwindigkeit bringen

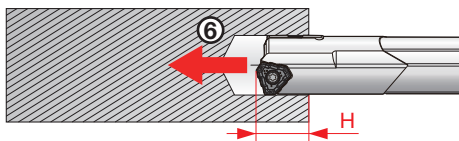

⑥ Vorschub starten

Am Anfang (H = 15 - 25 mm)
→ Vorschub $f = 80\%$ der programmierten
Vorschubgeschwindigkeit
Bohrungstiefe: $H \geq 25 \text{ mm}$ → Vorschub $f = 100\%$

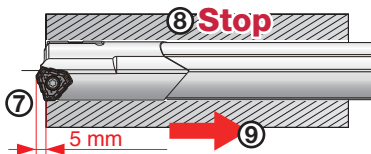

⑦ Für Durchgangsbohrung

Bohren bis der Bohrer 5 mm aus dem Werkstück hervorragt

⑧ Stoppen der Drehzahl und der Kühlung

⑨ Zurückfahren des Bohrers zur Startposition

VERWENDUNG VON DEEPTRI-DRILL TYP **TRLG** AUF EINEM HORIZONTALEN BEARBEITUNGSZENTRUM ODER BOHRWERK

Bei Verwendung des TRLG-Tieflochbohrers auf einem konventionellen Bearbeitungszentrum oder einer Horizontalbohrmaschine, wo keine Bohrbuchsenstützen vorhanden sind, muss eine tiefere Pilotbohrung mit einem MCTR-Bohrer gebohrt werden, um den langen Tieflochbohrer besser zu unterstützen. Ein langer Tieflochbohrer wie der TRLG-Bohrer neigt zum aufschwingen, wenn die Pilotbohrung nicht tief genug ist.



① Pilotbohrung

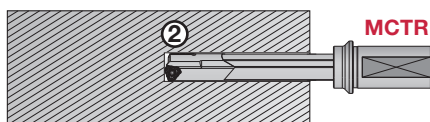

② Pilotbohrung vergrößern mit einem MCTR Bohrer

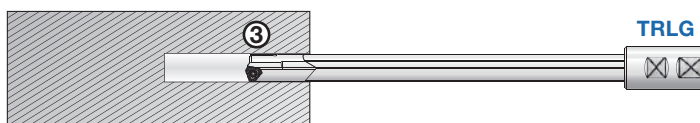

③ Bohren Sie mit einem TRLG-Bohrer mit reduzierter Drehzahl und Vorschub. Verwenden Sie die folgenden Parameter:
Drehzahl: $n = 50 - 100 \text{ min}^{-1}$
Vorschubgeschwindigkeit: $V_f = 100 - 300 \text{ mm/min}$

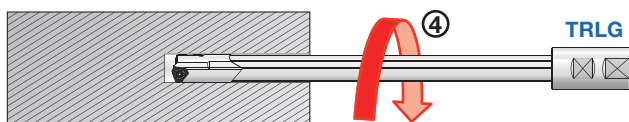

④ Wenn der DeepTri-Drill das Ende der Pilotbohrung erreicht hat, erhöhen Sie die Bohrerrotation auf volle Bearbeitungsgeschwindigkeit.



⑤ Vorschub starten um den Bohrvorgang zu beenden

(Warnung)

Verwenden Sie immer Punkt ② um zu verhindern, dass der Tieflochbohrer aufschwingt, was zu Bohrerbruch und einer möglichen überflüssigen Verletzung führen kann.

WERKZEUGAUSWAHL IM HINBLICK AUF QUERLOCHDURCHMESSER UND BOHRERDURCHMESSER

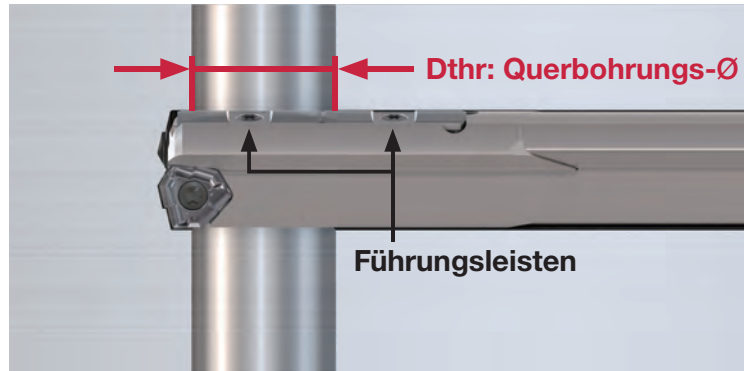
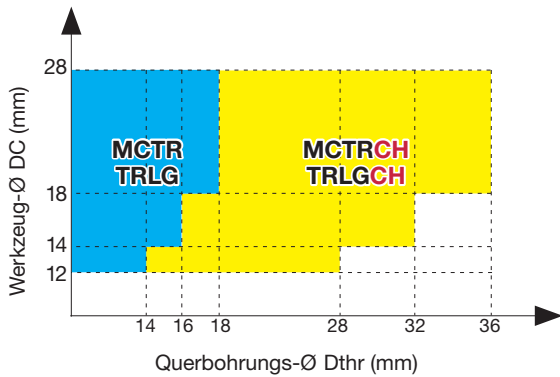

Hinweise zu Querbohrungen

- Vorschub verringern, wenn der Bohrer auf eine Querbohrung trifft. ($f = 0.03 - 0.05 \text{ mm/U}$)
- Tieflochbohrer langsam drehend zurück ziehen. ($n = 100 \text{ min}^{-1}$, $V_f = 300 \text{ mm/min}$)
- Wenn der Tieflochbohrer schnell und ohne Drehung zurückgezogen wird, können die Wendschneidplatten und/oder Führungsleisten mit entstandenem Grat an den Querbohrungen in Berührung kommen und beschädigt werden.

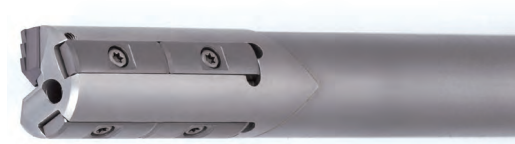

Konzipiert für Querbohrungen

Verformung durch Zentrifugalkraft

Der Gundrill ist dafür bekannt, dass er unter bestimmten Umständen aufschwingt. Dies ist von der Werkzeuglänge und der Schnittgeschwindigkeit abhängig. Wenn die Parameter in der Verformungszone liegen, wie in der Grafik gezeigt, sollten Sie die Schnittgeschwindigkeit ändern oder eine Lünettenbuchse verwenden.

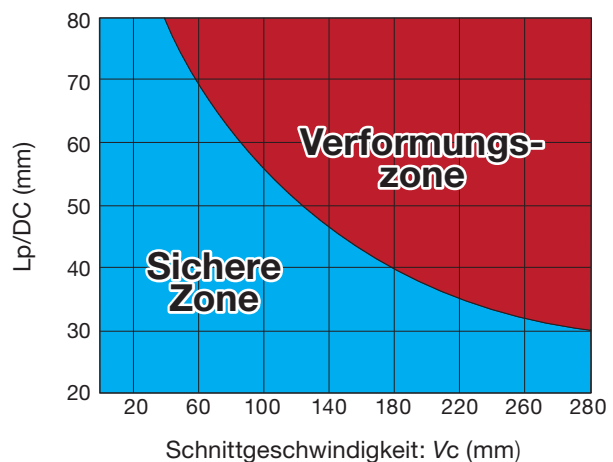
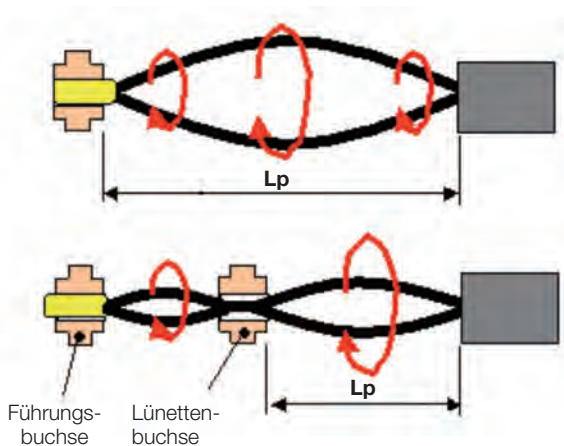

Empfehlung zur Lünettenbuchse

Eine Lünettenbuchse, in Form eines Lagers und einer GIZMO-Buchse* ist für ein prozesssicheres Bohren unbedingt zu empfehlen.

* GIZMO Führungsbuchse ist ein eingetragener, geschützter Markenname

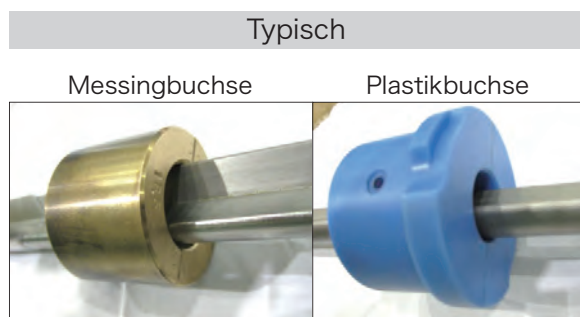

PRAKTISCHE BEISPIELE Neu

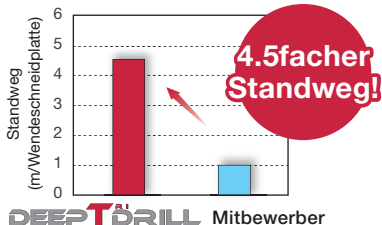
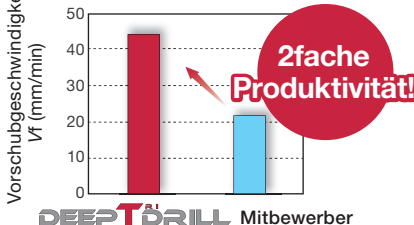
Werkstück		Rohrboden	Kunststoffform
Bohrer		MCTR20.00XM32-10	TRLGCH18.00X1500-36A
Wendeschneidplatte		TOHT090305R-NDL	TOHT080305R-NDJ
Schneidstoff		AH725	AH725
Führungsleiste		GP06-085 F2122	GP06-075 F2122
Werkstoff		X5CrNi18-9 M	X40CrMoV5-1 (45 HRC) P
Schnittbedingungen	Schnittgeschwindigkeit: V_c (m/min)	80	62
	Vorschub : f (mm/U)	0.04	0.04
	Vorschubgeschw.: V_f (mm/min)	53	44
	Bohrtiefe : H (mm)	200	700
	Maschine	Horizontales BAZ	Horizontales BAZ
	Kühlung	Emulsion	Emulsion
Resultat		 <p>Standweg (m/Wendeschneidplatte)</p> <p>DEEPT^{RI} Mitbewerber</p>	 <p>Vorschubgeschwindigkeit V_f (mm/min)</p> <p>DEEPT^{RI} Mitbewerber</p>

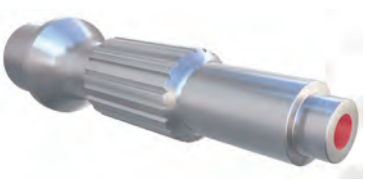
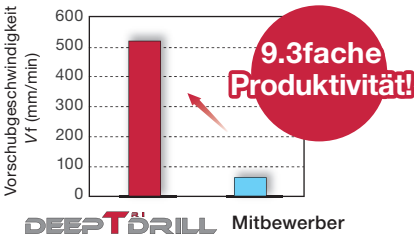
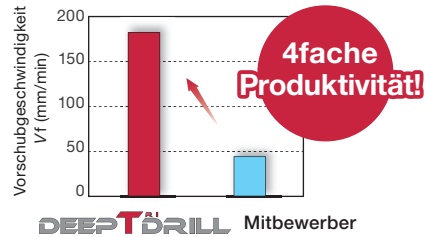
Werkstück		Schaft	Achswelle
Bohrer		MCTR12.00XM20-20	MCTR14.00XM25-15
Wendeschneidplatte		LOGT060204R-NDJ	TOHT070304R-NDJ
Schneidstoff		AH725	AH725
Führungsleiste		GP04-055 F2122	GP05-060 F2122
Werkstoff		SCM420H	42CrMo4
		 P	 P
Schnitt- bedingungen	Schnittgeschwindigkeit: V_c (m/min)	150	80
	Vorschub : f (mm/U)	0.13	0.1
	Vorschubgeschw. : V_f (mm/min)	517	182
	Loch-Ø : D_c (mm)	12	14
	Bohrtiefe : H (mm)	233	200
	Maschine	Vertikales BAZ	Drehmaschine
	Kühlung	Emulsion	Innen
Resultat		 Vorschubgeschwindigkeit V_f (mm/min) DEEPTDRILL Mitbewerber	 Vorschubgeschwindigkeit V_f (mm/min) DEEPTDRILL Mitbewerber

Tungaloy Corporation (Hauptsitz)

11-1 Yoshima-Kogyodanchi
Iwaki-city, Fukushima, 970-1144 Japan
Phone: +81-246-36-8501
Fax: +81-246-36-8542
www.tungaloy.co.jp

Tungaloy America, Inc.

3726 N Ventura Drive
Arlington Heights, IL 60004, U.S.A.
Phone: +1-888-554-8394
Fax: +1-888-554-8392
www.tungaloyamerica.com

Tungaloy Canada

432 Elgin St. Unit 3
Brantford, Ontario N3S 7P7, Canada
Phone: +1-519-758-5779
Fax: +1-519-758-5791
www.tungaloy.com/ca

Tungaloy de Mexico S.A.

C Los Arellano 113,
Parque Industrial Siglo XXI
Aguascalientes, AGS, Mexico 20290
Phone: +52-449-929-5410
Fax: +52-449-929-5411
www.tungaloy.com/mx

Tungaloy do Brasil Ltda.

Avd. Independencia N4158 Residencial Flora
13280-000 Vinhedo, São Paulo, Brasil
Phone: +55-19-38262757
Fax: +55-19-38262757
www.tungaloy.com/br

Tungaloy Germany GmbH

An der Alten Ziegelei 1
D-40789 Monheim, Germany
Phone: +49-2173-90420-0
Fax: +49-2173-90420-19
www.tungaloy.de

Tungaloy France S.A.S.

ZA Courtaboeuf - Le Rio
1 rue de la Terre de feu
F-91952 Courtaboeuf Cedex, France
Phone: +33-1-6486-4300
Fax: +33-1-6907-7817
www.tungaloy.fr

Tungaloy Italia S.r.l.

Via E. Andolfato 10
I-20126 Milano, Italy
Phone: +39-02-252012-1
Fax: +39-02-252012-65
www.tungaloy.it

Tungaloy Czech s.r.o.

Turanka 115
CZ-627 00 Brno, Czech Republic
Phone: +420-532 123 391
Fax: +420-532 123 392
www.tungaloy.cz

Tungaloy Ibérica S.L.

C/Miquel Servet, 43B, Nau 7
Pol. Ind. Bufalvent
ES-08243 Manresa (BCN), Spain
Phone: +34 93 113 1360
Fax: +34 93 876 2798
www.tungaloy.es

Tungaloy Scandinavia AB

Bultgatan 38
442 40 Kungälv, Sweden
Phone: +46-462119200
www.tungaloy.se

Tungaloy Rus, LLC

115432, Moscow, Andropov Avenue, 18,
building 7, 11th floor (office 3). Metro station
"Technopark". Business center «I-Land».
Phone: +7-499-683-01-80/81
www.tungaloy.com/ru

Tungaloy Polska SS. z o.o.

ul. Genewska 24
03-963 Warszawa, Poland
Phone: +48-22-617-0890
Fax: +48-22-617-0890
www.tungaloy.com/pl

Tungaloy U.K. Ltd

Gallan Park, Waitling Street
Cannock, WS11 0XG, UK
Phone: +44 121 4000 231
Fax: +44 121 270 9694
www.tungaloy.com/uk
salesinfo@tungaloyuk.co.uk

Tungaloy Hungary Kft

Erzsébet királyné útja 125
H-1142 Budapest, Hungary
Phone: +36 1 781-6846
Fax: +36 1 781-6866
www.tungaloy.com/hu
info@tungaloytools.hu

Tungaloy Turkey

Dudullu, OSB 4. Cad No:4
34776 Umranıye Istanbul, TURKEY
Phone: +90 216 540 04 67
Fax: +90 216 540 04 87
www.tungaloy.com.tr
info@tungaloy.com.tr

Tungaloy Benelux b.v.

Tjalk 70
NL-2411 NZ Bodegraven, Netherlands
Phone: +31 172 630 420
Fax: +31 172 630 429
www.tungaloy-benelux.com

Tungaloy Croatia

Ulica bana Josipa Jelačića 87,
10430 Samobor
Phone: +385 1 3326 604
Fax: +385 1 3327 683
www.tungaloy.hr

Tungaloy Cutting Tool (Shanghai) Co., Ltd.

Rm No 401 No.88 Zhabei
Jiangchang No.3 Rd
Shanghai 200436, China
Phone: +86-21-3632-1880
Fax: +86-21-3621-1918
www.tungaloy.com/cn

Tungaloy Cutting Tool (Thailand) Co., Ltd.

Interlink tower 4th Fl.
1858/5-7 Bangna-Trad Road
km.5 Bangna, Bangna, Bangkok 10260
Thailand
Phone: +66-2-751-5711
Fax: +66-2-751-5715
www.tungaloy.co.th

Tungaloy Singapore (Pte.), Ltd.

62 Ubi Road 1, #06-11 Oxley BizHub 2
Singapore 408734
Phone: +65-6391-1833
Fax: +65-6299-4557
www.tungaloy.com/sg

Tungaloy Vietnam

LE 04-38, Lexington Residence
67 Mai Chi Tho, Dist. 2,
Ho Chi Minh City, Vietnam
Phone: +84-8-37406660
Fax: +84-8-37406662
www.tungaloy.com/sg

Tungaloy India Pvt. Ltd.

Indiabulls Finance Centre,
Unit # 902-A, 9th Floor,
Tower 1, Senapati Bapat Marg,
Elphinstone Road (West),
Mumbai -400013, India
Phone: +91-22-6124-8804
Fax: +91-22-6124-8899
www.tungaloy.com/in

Tungaloy Korea Co., Ltd

#1312, Byucksan Digital Valley 5-cha
Beotkot-ro 244, Geumcheon-gu
153-788 Seoul, Korea
Phone: +82-2-2621-6161
Fax: +82-2-6393-8952
www.tungaloy.com/kr

Tungaloy Malaysia Sdn Bhd

50 K-2, Kelana Mall, Jalan SS6/14
Kelana Jaya, 47301
Petaling Jaya, Selangor Darul Ehsan
Malaysia
Phone: +603-7805-3222
Fax: +603-7804-8563
www.tungaloy.com/my

Tungaloy Australia Pty Ltd

PO Box 2232, 68/1470
Ferntree Gully Road, Knoxfield
Victoria 3180, Australia
Phone: +61-3-9755-8147
Fax: +61-3-9755-6070
www.tungaloy.com.au

PT. Tungaloy Indonesia

Kompleks Grand Wisata Block AA-10 No.3-5
Cibitung
Bekasi 17510, Indonesia
Phone: +62-21-8261-5808
Fax: +62-21-8261-5809
www.tungaloy.com/id



www.tungaloy.de

webshop.tungaloy.de
xing.com/pages/tungaloy
facebook.com/tungaloygermanygmbh
instagram.com/tungaloygermany
youtube.com/tungaloycorporation
linkedin.com/company/tungaloy-germany-gmbh



AS9100 Certified
78006
2015.11.04
ISO14001 Certified
EC97J1123
1997.11.26

Ausgehändigt durch:



FIND US ON THE CLOUD!
machingcloud.com

